



Lab Bench Pedestal Table Boxes provide access to power and communications services.



Isoduct® 4-Gang Lab Bench Table Box.

Multi-Service Pedestal Table Boxes for Laboratory Applications

Multi-Service Pedestal Table Boxes provide convenient access to high capacity power, communication and A/V services in a sleek contemporary styling with a clear, anodized aluminum finish. All models include a divider that allows units to be field-configured for one or multiple compartments, providing flexibility and accessibility on either side of a desk or lab bench. Models can also be used without the included partitions for all power or all data applications.

The satin anodized aluminum finish makes the unit an attractive complement to Isoduct® Series Raceway installations in laboratory settings and can be used on laboratory furniture, where shelving is not present, to secure horizontal runs of raceway. Laboratory Pedestal Table Boxes help to comply with ADA requirements by making power and data more accessible to all users. Combination 1/2" and 3/4" conduit knockouts on the bottom provide easy accessibility.

Features & Benefits

- **Multi-compartment.** Use of included divider provides configuration flexibility to field-configure pedestal table boxes for power and data/A/V applications or without the divider for all power or all data/A/V applications.
- **Durable anodized aluminum finish.** Provides modern, aesthetically pleasing look that blends well with furniture and raceways used in labs, while providing an added level of protection and durability required for lab environments.
- **Protection against spills.** The Lab Bench Table Box is the first lab bench activation to be tested to the proposed UL111 standard for multi-outlet assemblies. This standard includes a spill test, which proves there is no risk of shock or short circuiting due to moisture when combined with certain Pass and Seymour receptacles. Complete list of tested devices can be found on pages 4 and 5.
- **Variety of faceplate configurations available.** Allows the flexibility to configure service fittings to meet power, data and A/V requirements now and in the future, reducing overall life cycle costs.
- **Datacom connectivity options.** Accepts industry standard and proprietary devices from a wide range of manufacturers to provide a seamless and aesthetically pleasing interface for voice, data, audio, and video applications at the point of use.

Vertical Markets

- Commercial
- Education
- Healthcare
- Hospitality
- Entertainment
- Retail



Compliance



cULus Listed, Metallic Outlet Box File Number E2961, Guide QCIT.
Meets Article 314.27(C) of NEC.

cULus Listed Multioutlet Assembly File Number E15191, Guide PVGT.
Meets Article 380 of NEC, Meets Article 12-3032 of CEC.
Evaluated for use on Laboratory Bench work surfaces

Pedestal Table Boxes Quick Selection Guide

PEDESTAL TABLE BOX MODEL	COMPARTMENTS	SERVICE LOCATION	SPILL WATER COMPLIANT	COVER COLOR/MATERIAL	ELECTRICAL OUTLETS	DATA OPENINGS	A/V OPENINGS
Lab Bench Pedestal Table Box (2-Gang) 	Two	Above	Yes	Clear Anodized Aluminum	(1) 15A, 20A simplex or duplex, GFCI, or 30A Turnlok® per gang	Up to four (4) keystone jacks per gang using Wiremold AVIP Series Device Plates	Four Legrand AVIP Series or Extron-Electronics MAAP Modules or Two Extron-Electronics AAP Modules per gang*
AL241S-HB Pedestal Table Box 	Four	Above	No	Clear Anodized Aluminum	(1) 15A, 20A simplex or duplex, GFCI, or 30A Turnlok® per gang	Up to four (4) keystone jacks per gang using Wiremold AVIP Series Device Plates	N/A

* Extron® Electronics MAAP modules are sold separately.

Lab Bench Pedestal Table Boxes

The new Lab Bench Pedestal Table Boxes provide increased capacity and access to multiple services in a variety of configurations to meet the demanding needs of laboratory activity. These field-wired units can be added to existing benches or designed into new lab construction. UL has evaluated these boxes for use on laboratory bench work surfaces. Pass & Seymour® receptacles were installed in the box and subjected to spill testing outlined in UL 111. The test results showed that there was no risk of fire or electrical shock as a result of the spill.



Lab Bench Pedestal Table Boxes provide access to power and communications services.

CODE REFERENCE

cULus Listed Metallic Outlet Boxes:
File E2961, Guide QCIT
Meets Article 314.27(C) of NEC

cULus Listed Multioutlet Assembly:
File E15191, Guide PVGT
Meets Article 380 of NEC
Meets Article 12-3032 of CEC
Evaluated for use on Laboratory Bench work surfaces

LAB BENCH PEDESTAL TABLE BOXES COLOR OPTIONS

Lab Bench Table Boxes are available in a clear anodized aluminum finish.

Lab Bench Pedestal Table Boxes Ordering Information

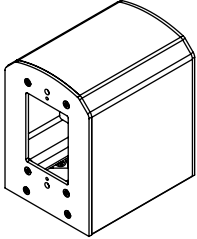
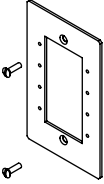
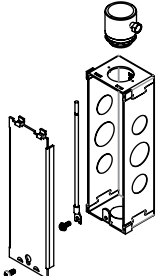
Catalog No./Item	Description/Specifications	Catalog No./Item	Description/Specifications
LBP2	 <p>Lab Bench Pedestal – Aluminum housing and side plates, with a steel base and divider, measures 4" x 5" x 5/8" (102mm x 127mm x 143mm). Base is configurable to have a combination of two (2) 3/4" knockouts or two (2) 3/4" EMT stubs. Accommodates a variety of power outlets (duplex, decorator, GFCI and up to 30A twist lock). Use Wiremold AVIP to provide communications and A/V. Receptacles and wall plates are sold separately. See chart on next page for list of Pass & Seymour® receptacles that were evaluated by UL for use with the box on laboratory bench work surfaces.</p> <p>Country of Origin: USA</p>	LBP-MAAP	 <p>Lab Bench MAAP Plate – Plate is finished black to match Wiremold AVIP devices. Used to provide communication and A/V services</p> <p>Country of Origin: USA</p>
LBPBHA	 <p>Bottom Housing Unit – One gang 3/4" trade size conduit housing assembly. Assembly includes junction box and 3/4" trade size fitting to attach to 3/4" trade size conduit for power connections. See chart on next page for list of Pass & Seymour® receptacles that were evaluated by UL for use with the box on laboratory bench work surfaces.</p> <p>Country of Origin: USA</p>		

Lab Bench Pedestal Table Boxes & Compatible Pass & Seymour® Devices
GFCI Devices

Straight Blade GFCI	Tamper Resistant GFCI	PlugTail GFCI	Hospital Grade GFCI	PlugTail Hospital Grade GFCI	Deadfront GFCI
1595	1595NTLTR	PT1595	1595HG	PT1595HG	2085
2095	1595TR	PT1595NTLTR	1595HGNTLTR	PT1595HGNTLTR	
1595DSWR	1595TRS	PT1595TR	1595HGTR	PT1595HGTR	
1595R	1595TRWR	PT2095	2095HG	PT2095HG	
1595S	2095NTLTR	PT2095NTLTR	2095HGNTLTR	PT2095HGNTLTR	
2095DSWR	2095TR	PT2095TR	2095HGTR	PT2095HGTR	
2095S	2095TRS				
2095TRWR					

Hospital Grade Devices

Hospital Grade GFCI	PlugTail Hospital Grade GFCI	PlugTail Hospital Grade	Isolated Ground	15A Hospital Grade	20A Hospital Grade
1595HG	PT1595HG	PT8200	IG26262HG	8200	8300
1595HGNTLTR	PT1595HGNTLTR	PT8200IL	IG26362HG	8201	8301
1595HGTR	PT1595HGTR	PT8300	IG8200	26222HG	8800
2095HG	PT2095HG	PT8300IL	IG8300	26262HG	8801
2095HGNTLTR	PT2095HGNTLTR	PTTR62H	IG8301	8200H	26322HG
2095HGTR	PT2095HGTR	PTTR63H	IG8800	8200IL	26362HG
	PTTR8200	TRIG26262HG	PS8200H	8300H	
	PTTR8300	TRIG26362HG	PS8200HS	8300IL	
		TRIG8200	TR26262HG	PS8300H	
		TRIG8300	TR62H	PS8300HS	
				TR26362HG	
				TR63H	

Straight Blade Devices

Tamper Resistant	15A Devices	20A Devices	15A Weather & Corrosion Resistant	20A Weather & Corrosion Resistant	TR USB
TR15	5251	5351	CR15	CR20	TM8-USB
TR20	5261	5361	CR6207	CR6307	
TR26261	5262	5362	CRB5262	CRB5362	
TR26262	5290	5850	CRB5262S	CRB5362S	
TR26361	5651	5851	WR5262	WR20TR	
TR26362	5662	5862	WR5662	WR5362	
TR5251	5671	5871		WR5862	
TR5262	6207	5890			
TR5351	26252	6307			
TR5362	26652	26352			
TR62	26661	26852			
TR63	5262A	26861			
WR20TR	5662A	5362A			
PS5262	5862A				
	PS5362				

Lab Bench Pedestal Table Boxes & Compatible Pass & Seymour® Devices
Isolated Ground Devices

Hospital Grade IG	Locking IG	15A Isolated Ground	20A Isolated Ground
IG26262HG	IG4700	TRIG26262	TRIG26362
IG26362HG	IG4710	TRIG5262	TRIG5362
IG8200	IGL520R	IG26262	IG26362
IG8300	IGL530R	IG5261	IG5361
IG8301	IGL620R	IG5262	IG5362
IG8800	IGL630R	IG5662	IG5862
TRIG26262HG	IGL1420R		
TRIG26362HG	IGL1430R		
TRIG8200	IGL1520R		
TRIG8300	IGL1530R		
IGL2120R			
IGL2130R			

PlugTail Receptacles

PlugTail GFCI	PlugTail Hospital Grade	PlugTail Hospital Grade GFCI	PlugTail TR Grade	PlugTail 15A & 20A
PT1595	PT1595HG	PT8200	PTTR5262	PT5262A
PT1595NTLTR	PT1595HGNTLTR	PT8200IL	PTTR5262SC	PT5362A
PT1595TR	PT1595HGTR	PT8300	PTTR5362	
PT2095	PT2095HG	PT8300IL	PTTR5362SC	
PT2095NTLTR	PT2095HGNTLTR	PTTR62H	PTTR62	
PT2095TR	PT2095HGTR	PTTR63H	PTTR63	
	PTTR8200			
	PTTR8300			

Locking Receptacles

Turnlok IG	20A Turnlok	30A Turnlok
IG4700	7310	3330
IG4710	7410	3430
IGL520R	CRL520R	3330G
IGL530R	L1020R	CRL530R
IGL620R	L1120R	L1030R
IGL630R	L1420R	L1130R
IGL1420R	L1520R	L1430R
IGL1430R	L1820R	L1530R
IGL1520R	L2120R	L1830R
IGL1530R	L520R	L2130R
IGL2120R	L620R	L530R
IGL2130R	L630R	

Isoduct® 4-Gang Lab Bench Table Boxes

Isoduct® 4-Gang Lab Bench Table Boxes (AL241S-HB) provide high capacity power and communication services in a sleek contemporary styling with a clear, anodized aluminum finish. Each unit comes with both a front-to-back and side-to-side divider that allows either power and data to be on one side, or all power on one side and all data on the other providing maximum flexibility and accessibility on either side of a desk or lab bench. Unit can also be used without any partitions and house all power or all data. The communication faceplates accommodate Pass & Seymour Activate™ and Wiremold Communication Modular Inserts for UTP, fiber, coax, audio, and video applications. The satin anodized aluminum finish makes the unit an attractive complement to the Isoduct Series Raceway in laboratory settings and can be used on laboratory furniture where shelving is not present to secure horizontal raceway. The unit also helps to comply with ADA requirements to make power and data more accessible to all users. Combination 1/2" and 3/4" conduit knockouts on the bottom provide easy accessibility.



Isoduct® 4-Gang Lab Bench Table Box (AL241S-HB) installed on a work surface.

CODE REFERENCE

cULus Listed Metallic Outlet Boxes:
File E2961, Guide QCIT
Listed to US and Canadian Safety Standards

**AL241S-HB PEDESTAL TABLE BOXES
COLOR OPTIONS**

Lab Bench Table Boxes are available in a clear anodized aluminum finish.

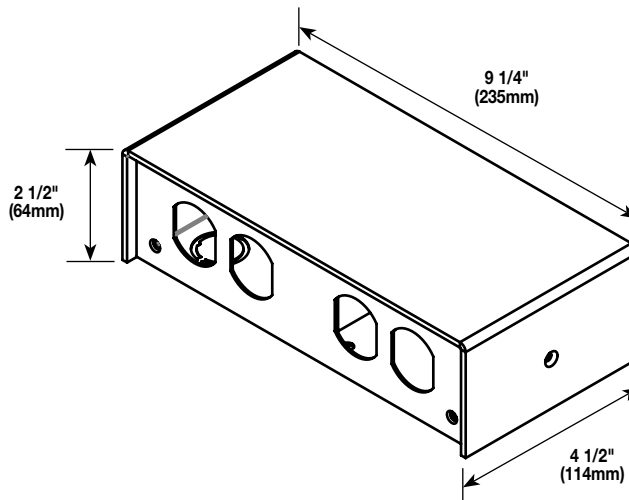

Isoduct® 4-Gang Lab Bench Table Boxes Ordering Information

Catalog No./Item	Description/Specifications
AL241S-HB	<p>Housing and Base – Order part number AL241S-HB for the base unit, which is shipped unassembled with both a front-to-back and side-to-side divider. Combine with faceplates to complete pedestal assembly.</p> <p>Country of Origin: USA</p>

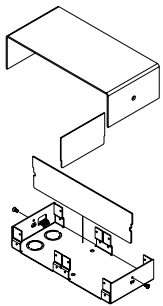

Isoduct® 4-Gang Lab Bench Table Boxes Faceplate Ordering Information

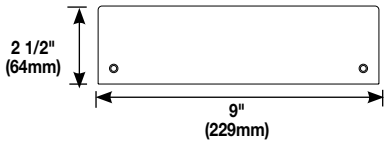
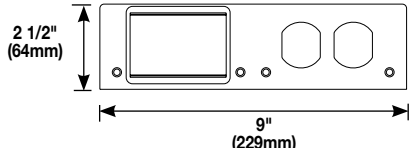
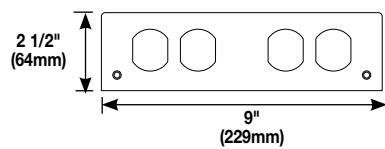
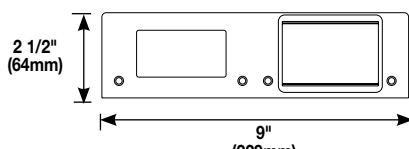
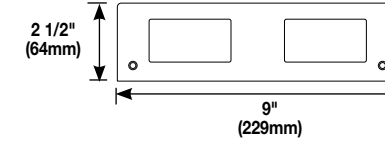
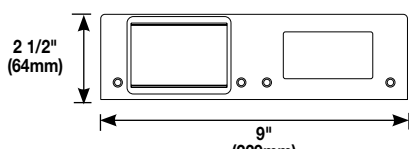
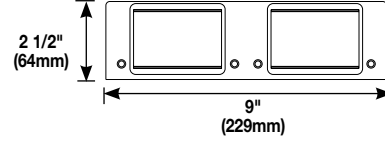
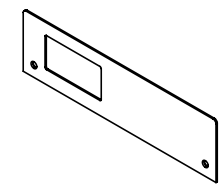
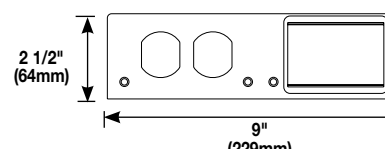
Catalog No./Item	Description/Specifications	Catalog No./Item	Description/Specifications
AL241FPB-B	Blank Faceplate – Two-gang, blank faceplate. Country of Origin: USA	AL241FP6A-D	Duplex & Activate (rule of six) Faceplate – Two-gang faceplate with one Activate and one duplex device opening. Activate adapter included. Country of Origin: USA
			
AL241FPD-D	Double Duplex Faceplate – Two-gang faceplate with two duplex receptacle openings. Country of Origin: USA	AL241FPDEC-6A	GFCI/Surge & Activate (rule of six) Faceplate – Two-gang faceplate with one GFCI/Surge and one Activate device opening. Activate adapter included. Country of Origin: USA
			
FP2G2GFI	Double GFCI Faceplate – Two-gang faceplate with two surge suppression device openings. Country of Origin: USA	AL241FP6A-DEC	Activate & GFCI/Surge (rule of six) Faceplate – Two-gang faceplate with one Activate and one GFCI/Surge device opening. Activate adapter included. Country of Origin: USA
			
AL241FP6A-6A	Double Activate (rule of six) Faceplate – Two-gang faceplate with two Activate device openings. Two Activate adapters included. Country of Origin: USA	AL241FPDEC-B	Decorator/Blank Faceplate – Two-gang faceplate with one decorator device opening and one blank. Country of Origin: USA
			
AL241FP6D-6A	Duplex & Activate (rule of six) Faceplate – Two-gang faceplate with one duplex and one Activate device opening. Activate adapter included. Country of Origin: USA		
			

Isoduct® 4-Gang Lab Bench Table Boxes Faceplate Ordering Information

Catalog No./Item	Description/Specifications	Catalog No./Item	Description/Specifications
AL241FPB-6A	<p>Blank/Communication Faceplate – Two-gang faceplate with one blank and one Ortronics® or Wiremold Open System communication module opening.</p> <p>Country of Origin: USA</p>	AL241FPB-D	<p>Blank/Duplex Faceplate – Two-gang faceplate with blank on the left side and duplex device opening on the right side.</p> <p>Country of Origin: USA</p>
AL241FP6A-B	<p>Communication/Blank Faceplate – Two-gang faceplate with one Ortronics® or Wiremold Open System communication module opening and one blank.</p> <p>Country of Origin: USA</p>	AL241FPD-B	<p>Duplex/Blank Faceplate – Two-gang faceplate with a duplex device opening on the left side and a blank on the right side.</p> <p>Country of Origin: USA</p>

NOTE: All brand and product names referenced in this document are registered trademarks or trademarks of their respective holders.

NOTE: The paper used to print this document is an environmentally responsible paper with 10% post consumer waste, with FSC and SFI Chain of Custody certifications, Lacey Act compliant. 100% of the electricity used to manufacture Flo sheets is generated with Green-e certified renewable energy.



Legrand, North America
60 Woodlawn Street
West Hartford, CT 06110
1.877.BY.LEGRAND (295.3472)
www.legrand.us

Canada
905.738.9195
www.legrand.ca

