

Protection Equipment

**NEW**

Click on the Article No. in the catalog PDF to access it in the Industry Mall and get all related information.

Article-No.

3RA1943-2C
3RA1943-2B
3RA1953-2B
3RA1953-2N



Or directly in the Internet, e. g.
[www.siemens.com/
product?3RA1943-2C](http://www.siemens.com/product?3RA1943-2C)

Price groups

PG 140, 41B, 41E, 41F, 41G, 41H, 41J,
42F, 42J

7/2 **Introduction****Motor starter protectors/
circuit breakers**

SIRIUS 3RV2 motor starter protectors/
circuit breakers up to 80 A

7/7 General data

7/21 For motor protection **NEW**7/25 For motor protection with
overload relay function **NEW**7/26 For starter combinations **NEW**7/28 For transformer protection **NEW**7/29 For system protection according to
UL 489/CSA C22.2 No. 5 **NEW**7/30 For transformer protection according to
UL 489/CSA C22.2 No.5 **NEW**

Accessories

7/31 - Mountable accessories

7/34 - Busbar accessories

7/37 - Rotary operating mechanisms

7/38 - Mounting accessories

7/43 - Enclosures and front plates

7/46 3RV29 infeed system

SIRIUS 3RV1 motor starter protectors/
circuit breakers up to 100 A

7/51 General data

7/63 For motor protection

7/64 For motor protection
with overload relay function

7/65 For starter combinations

7/66 For fuse monitoring

7/67 For system protection according to
UL 489/CSA C22.2 No. 5

7/68 For distance protection

Accessories

7/69 - Mountable accessories

7/72 - Busbar accessories

7/73 - Rotary operating mechanisms

7/75 - Mounting accessories

7/77 - Front plates

SIRIUS 3RV1 molded case motor starter
protectors up to 800 A

7/78 General data

7/83 For motor protection

7/84 For starter combinations

Accessories

7/85 - Mountable accessories

7/86 - Rotary operating mechanisms,
mounting accessories**Overload relays**

7/87 General data

SIRIUS 3RU2
thermal overload relays

7/95 3RU2 up to 80 A
for standard applications **NEW**

7/103 Accessories

SIRIUS 3RU1
thermal overload relays

7/106 3RU11 up to 100 A
for standard applications

7/112 Accessories

SIRIUS 3RB3
electronic overload relays

7/114 3RB30, 3RB31 up to 80 A
for standard applications **NEW**

7/122 Accessories

SIRIUS 3RB2
electronic overload relays

7/124 3RB20, 3RB21 up to 630 A
for standard applications

7/133 Accessories for 3RB20, 3RB21

7/135 3RB22, 3RB23 up to 630 A
for High-Feature applications7/143 3RB24 for IO-Link, up to 630 A
for High-Feature applications7/150 Current measuring modules for
3RB22, 3RB23, 3RB24

7/153 Accessories for 3RB22, 3RB23, 3RB24

Notes:

The 3RV1, 3RU1 and 3RB2 devices
(sizes S00/S0 to S12) can be found

- in the Catalog Add-On
IC 10 AO · 2015
at the Information and
Download Center
- in the interactive catalog CA 01
- in the Industry Mall

Conversion tool, e.g. from

- 3RV1 to 3RV2
- 3RU11 to 3RU21
- 3RB20/3RB21 to 3RB30/3RB31

see

www.siemens.com/sirius/conversion-tool

Protection Equipment

Motor Starter Protectors/Circuit Breakers

Introduction

Overview



Type	3RV20	3RV21	3RV23	3RV24	3RV27	3RV28
SIRIUS 3RV2 motor starter protectors/circuit breakers up to 80 A						
Applications						
• System protection	✓ ¹⁾	✓ ¹⁾	--	--	✓	✓
• Motor protection	✓	--	--	--	--	--
• Motor protection with overload relay function	--	✓	--	--	--	--
• Starter combinations	--	--	✓	--	--	--
• Transformer protection	--	--	--	✓	✓	✓
Size	S00, S0, S2	S00, S0, S2	S00, S0, S2	S00, S0, S2	S00, S0	S00, S0
Rated current I_n						
• Size S00	A Up to 16	Up to 16	Up to 16	Up to 16	Up to 15	Up to 15
• Size S0	A Up to 40	Up to 32	Up to 40	Up to 25	Up to 22	Up to 22
• Size S2	A Up to 80	Up to 80	Up to 80	Up to 65	--	--
Rated operational voltage U_e according to IEC	V 690 AC ²⁾	690 AC ²⁾	690 AC ²⁾	690 AC ²⁾	690 AC	690 AC
Rated frequency	Hz 50/60	50/60	50/60	50/60	50/60	50/60
Trip class	CLASS 10 (S00 ... S2), CLASS 20 (S2)	CLASS 10	--	CLASS 10	--	--
Thermal overload releases	A 0.11 ... 0.16 up to 70 ... 80	0.11 ... 0.16 up to 70 ... 80	None ³⁾	0.11 ... 0.16 up to 54 ... 65	0.16 ... 22 Non-adjustable	0.16 ... 22 Non-adjustable
Electronic release	A multiple of the rated current	13 times	13 times	20 times	13 times	20 times
Short-circuit breaking capacity I_{cu} at 400 V AC	kA 20/55/65/100	55/65/100	20/55/65/100	55/65/100	4)	4)
Pages	7/21 ... 7/23	7/25	7/26, 7/27	7/28	7/29	7/30

Accessories																
For sizes	S00	S0	S2	S00	S0	S2	S00	S0	S2	S00	S0	S2	S00	S0	S00	S0
Auxiliary switches	✓	✓	✓	✓	✓	✓	✓	✓	✓	✓	✓	✓	✓	✓	✓	✓
Signaling switches	✓	✓	✓	✓	✓	✓	✓	✓	✓	✓	✓	✓	--	--	--	--
Undervoltage releases	✓	✓	✓	--	--	--	✓	✓	✓	✓	✓	✓	✓	✓	✓	✓
Shunt releases	✓	✓	✓	--	--	--	✓	✓	✓	✓	✓	✓	✓	✓	✓	✓
Isolator modules	✓	✓	✓	✓	✓	✓	✓	✓	✓	✓	✓	✓	--	--	--	--
Insulated three-phase busbar system	✓	✓	✓	--	--	--	✓	✓	✓	✓	✓	✓	--	--	--	--
Busbar adapters	✓	✓	✓	✓	✓	✓	✓	✓	✓	✓	✓	✓	--	--	--	--
Door-coupling rotary operating mechanisms	✓	✓	✓	✓	✓	✓	✓	✓	✓	✓	✓	✓	✓	✓	✓	✓
Link modules	✓	✓	✓	✓	✓	✓	✓	✓	✓	✓	✓	✓	--	--	--	--
Enclosures for surface mounting	✓	✓	✓	✓	✓	✓	✓	✓	✓	✓	✓	✓	--	--	--	--
Enclosures for flush mounting	✓	✓	--	✓	✓	--	✓	✓	--	✓	✓	--	--	--	--	--
Front plates	✓	✓	✓	✓	✓	✓	✓	✓	✓	✓	✓	✓	--	--	--	--
Infeed system	✓	✓	--	--	--	--	✓	✓	--	✓	✓	--	--	--	--	--
Terminal covers for ring terminal lug connections	✓ ⁵⁾	✓ ⁵⁾	--	--	--	--	--	--	--	--	--	--	--	--	--	--
Sealable scale covers for setting knobs	✓	✓	✓	✓	✓	✓	--	--	--	✓	✓	✓	--	--	--	--
Pages	7/31 ... 7/50															

✓ Has this function or can use this accessory
 -- Does not have this function or cannot use this accessory

1) For symmetrical loading of the three phases.

2) With molded-plastic enclosure 500 V AC. For DC applications, see "Technical Specifications" → "DC Short-Circuit Breaking Capacity", page 7/16.

3) For overload protection of the motors, appropriate overload relays must be used.

4) According to UL 489 at 480 Y/277 V AC: 65 kA or 50 kA.

5) Terminal covers are available for 3RV20 motor starter protectors with ring terminal lug connection to ensure finger-safety.



Type	3RV10	3RV11	3RV13	3RV16	3RV16	3RV17
SIRIUS 3RV1 motor starter protectors/circuit breakers up to 100 A						
Applications						
• System protection	✓ ¹⁾	✓ ¹⁾	--	--	--	✓
• Motor protection	✓	--	--	--	--	--
• Motor protection with overload relay function	--	✓	--	--	--	--
• Starter combinations	--	--	✓	--	--	--
• Transformer protection	--	--	--	--	--	✓
• Fuse monitoring	--	--	--	✓	--	--
• Voltage transformer circuit breakers for distance protection	--	--	--	--	✓	--
Size	S3	S3	S3	S00	S00	S3
Rated current I_n						
• Size S00	A --	--	--	0.2	Up to 3	--
• Size S3	A Up to 100	Up to 100	Up to 100	--	--	Up to 70
Rated operational voltage U_e according to IEC	V 690 AC ²⁾	690 AC ²⁾	690 AC ²⁾	690 AC ²⁾	400 AC	690 AC
Rated frequency	Hz 50/60	50/60	50/60	50/60	16 ² / ₃ ... 60	50/60
Trip class	CLASS 10, 20	CLASS 10	--	--	--	--
Thermal overload releases	A 11 ... 16 up to 80 ... 100	11 ... 16 up to 80 ... 100	Without ³⁾	0.2	1.4 ... 3	10 ... 70 non-adjustable
Electronic release A multiple of the rated current	13 times	13 times	13 times	6 times	4 ... 7 times	13 times
Short-circuit breaking capacity I_{cu} at 400 V AC	kA 50/100	50/100	50/100	100	50	4)
Pages	7/63	7/64	7/65	7/66	7/68	7/67
Accessories						
For sizes	S3	S3	S3	S00	S00	S3
Auxiliary switches	✓	✓	✓	✓	✓	✓ ⁵⁾
Signaling switches	✓	✓	✓	--	--	--
Undervoltage releases	✓	--	✓	--	--	✓
Shunt releases	✓	--	✓	--	--	✓
Busbar adapters	✓	✓	✓	--	--	--
Door-coupling rotary operating mechanisms	✓	✓	✓	--	--	✓
Remote motorized operating mechanisms	✓	✓	✓	--	--	--
Link modules	✓	✓	✓	--	--	--
Front plates	✓	✓	✓	--	--	--
Pages	7/69 ... 7/77					

✓ Has this function or can use this accessory

-- Does not have this function or cannot use this accessory

1) For symmetrical loading of the three phases.

2) With molded-plastic enclosure 500 V AC. For DC applications, see "Technical Specifications" → "DC Short-Circuit Breaking Capacity", page 7/58.

3) For overload protection of the motors, appropriate overload relays must be used.

4) Acc. to UL 489
- At 480 Y/277 V AC: 65 kA
- At 480 V AC: 65 kA (10 A to 30 A)

5) Only lateral auxiliary switches can be fitted.

Protection Equipment

Motor Starter Protectors/Circuit Breakers

Introduction



Type	3RV10			3RV13					
SIRIUS 3RV1 molded case motor starter protectors up to 800 A									
Applications									
• Motor protection	✓			--					
• Starter combinations	--			✓					
Switching capacity	Standard switching capacity			Standard switching capacity			Increased switching capacity		
Size	3RV1063	3RV1073	3RV1083	3RV1353	3RV1363	3RV1373	3RV1383	3RV1364	3RV1374
Rated current I_n	A 100 ... 200	400	630	1 ... 32	100 ... 250	400, 630	630, 800	100 ... 250	400
Rated operational voltage U_e according to IEC	690 AC			690 AC					
Rated frequency	Hz 50/60			50/60					
Trip class	CLASS 10A, 10, 20, 30			-- ¹⁾					
Thermal overload releases	A 40 ... 100 up to A 252 ... 630			Without ¹⁾					
Electronic release A multiple of the rated current	Adjustable, 6 ... 13 times			Non-adjustable 1 ... 12.5 A: 13 times; Adjustable 20 A, 32 A: 6 ... 12 times		1 ... 10 times			
Short-circuit breaking capacity I_{cu} at 400 V AC	kA 120	120	100	85	120	120	100	200	200
Trip unit (release)	TU 4			TU 1: 1 ... 12.5 A; TU 2: 20 A, 32 A		TU 3			
Pages	7/83			7/84					
Accessories									
For molded case motor starter protectors	3RV1063	3RV1073	3RV1083	3RV1353	3RV1363	3RV1373	3RV1383	3RV1364	3RV1374
Auxiliary switches	✓	✓	✓	✓	✓	✓	✓	✓	✓
Undervoltage releases	✓	✓	✓	✓	✓	✓	✓	✓	✓
Shunt releases	✓	✓	✓	✓	✓	✓	✓	✓	✓
Rotary operating mechanisms	✓	✓	✓	✓	✓	✓	✓	✓	✓
Connection methods									
• Extended terminals on the front	✓	✓	--	✓	✓	✓	--	✓	✓
• Cable terminals on the front	✓	✓	✓	✓	✓	✓	✓	✓	✓
• Rear terminals	✓	✓	✓	✓	✓	✓	✓	✓	✓
Pages	7/85, 7/86								

✓ Has this function or can use this accessory
 -- Does not have this function or cannot use this accessory

¹⁾ For overload protection of the motors, appropriate overload relays must be used.



Type	3RU21			3RB30			3RB31			
SIRIUS overload relays up to 80 A										
Applications										
• System protection	✓ ¹⁾			✓ ¹⁾			✓ ¹⁾			
• Motor protection	✓			✓			✓			
• Alternating current, three-phase	✓			✓			✓			
• Alternating current, single-phase	✓			--			--			
• Direct current	✓			--			--			
Size contactor	S00, S0, S2			S00, S0, S2			S00, S0, S2			
Rated operational current I_e										
• Size S00	A	Up to 16			Up to 16			Up to 16		
• Size S0	A	Up to 40			Up to 40			Up to 40		
• Size S2	A	Up to 80			Up to 80			Up to 80		
Rated operational voltage U_e	V	690 AC			690 AC			690 AC		
Rated frequency	Hz	50/60			50/60			50/60		
Trip class		CLASS 10, 10A			CLASS 10E, 20E			CLASS 5E, 10E, 20E, 30E (adjustable)		
Thermal overload releases	A	0.11 ... 0.16 up to 70 ... 80			--			--		
Electronic overload releases	A	--			0.1 ... 0.4 up to 20 ... 80			0.1 ... 0.4 up to 20 ... 80		
Pages		7/100 ... 7/102			7/119, 7/120			7/121		
Accessories										
For sizes		S00	S0	S2	S00	S0	S2	S00	S0	S2
Terminal supports for stand-alone installation		✓	✓	✓	✓	✓	✓	✓	✓	✓
Mechanical RESET		✓	✓	✓	✓	✓	✓	✓	✓	✓
Cable releases for RESET		✓	✓	✓	✓	✓	✓	✓	✓	✓
Electrical remote RESET		✓	✓	✓	--	--	--	Integrated in the unit		
Terminal covers										
• Ring terminal lug connections		✓ ²⁾	✓ ²⁾	--	--	--	--	--	--	--
• For box terminals		--	--	✓	--	--	✓	--	--	✓
Sealable covers for setting knobs		✓	✓	✓	✓	✓	✓	✓	✓	✓
Pages		7/103 ... 7/105			7/122, 7/123			7/122, 7/123		

✓ Has this function or can use this accessory
-- Does not have this function or cannot use this accessory

¹⁾ The units are responsible in the main circuit for overload protection of the assigned electrical loads (e.g. motors), feeder cable, and other switching and protection devices in the respective load feeder.

²⁾ Terminal covers for ensuring finger-safe touch protection are available for 3RU21 overload relays with ring terminal lug connections for mounting onto contactors.

Protection Equipment

Overload Relays

Introduction



Type		3RU11	3RB20	3RB21	3RB22, 3RB23	3RB24
SIRIUS overload relays up to 630 A						
Applications						
• System protection		✓ ¹⁾	✓ ¹⁾	✓ ¹⁾	✓ ¹⁾	
• Motor protection		✓	✓	✓	✓	
• Alternating current, three-phase		✓	✓	✓	✓	
• Alternating current, single-phase		✓	--	--	✓	
• Direct current		✓	--	--	--	
Size contactor		S3	S3 ... S12	S3 ... S12	S00 ... S12	
Rated operational current I_e						
• Sizes S00 and S0	A	--	--	--	Up to 25 and 45 mm width with current measuring modules 3RB2906-2BG1/3RB2906-2DG1	
• Size S2	A	--	--	--	Up to 100 and 55 mm width with current measuring module 3RB2906-2JG1	
• Size S3	A	Up to 100	Up to 100	Up to 100	Up to 200 and 120 mm width with current measuring modules 3RB2956-2TH2/3RB2956-2TG2	
• Size S6	A	--	Up to 200	Up to 200	Up to 630 and 145 mm width with current measuring module 3RB2966-2WH2	
• Size S10/S12	A	--	Up to 630	Up to 630	Up to 820 with current measuring module 3RB2906-2BG1 and transformer 3UF1868-3GA00	
• Size 14 (3TF68/3TF69)	A	--	Up to 630	Up to 630		
Rated operational voltage U_e	V	690/1 000 AC	690/1 000 AC	690/1 000 AC	690/1 000 AC ²⁾	
Rated frequency	Hz	50/60	50/60	50/60	50/60	
Trip class		CLASS 10	CLASS 10, 20	CLASS 5, 10, 20, 30 Adjustable	CLASS 5, 10, 20, 30 Adjustable	
Thermal overload releases	A	18 ... 25 up to 80 ... 100	--	--	--	
Electronic overload releases	A	--	12.5 ... 50 up to 160 ... 630	12.5 ... 50 up to 160 ... 630	0.3 ... 3 up to 63 ... 630	
Pages		7/111	7/130, 7/131	7/132	7/141, 7/142, 7/152	7/149, 7/152
Accessories						
For sizes		S3	S3 S6 S10/S12	S3 S6 S10/S12	S00 S0 S2 S3 S6 S10/S12	
Terminal supports for stand-alone installation		✓	3) 3) 3)	3) 3) 3)	3) 3) 3) 3) 3) 3)	
Mechanical RESET		✓	✓ ✓ ✓	✓ ✓ ✓	-- -- -- -- -- --	
Cable releases for RESET		✓	✓ ✓ ✓	✓ ✓ ✓	-- -- -- -- -- --	
Electrical remote RESET		✓	-- -- --	Integrated in the unit	Integrated in the unit	
Terminal covers		✓	✓ ✓ ✓	✓ ✓ ✓	-- -- -- ✓ ✓ ✓	
Sealable covers for setting knobs		Integrated in the unit	✓ ✓ ✓	✓ ✓ ✓	✓ ✓ ✓ ✓ ✓ ✓	
Operator panel for 3RB24 evaluation module		--	-- -- --	-- -- --	✓ ✓ ✓ ✓ ✓ ✓	
Pages		7/112, 7/113	7/133, 7/134	7/133, 7/134	7/152 ... 7/154	

✓ Has this function or can use this accessory
 -- Does not have this function or cannot use this accessory

¹⁾ The units are responsible in the main circuit for overload protection of the assigned electrical loads (e.g. motors), feeder cable, and other switching and protection devices in the respective load feeder.

²⁾ With reference to the 3RB29.6 current measuring modules.

³⁾ Stand-alone installation without accessories is possible.

Motor Starter Protectors/Circuit Breakers

SIRIUS 3RV2 Motor Starter Protectors/Circuit Breakers up to 80 A

General data

Overview

The following illustration shows our 3RV2 motor starter protector/circuit breaker with the accessories which can be mounted for the sizes S00 to S2, see also "Introduction" → "Overview", page 7/2.

Accessories, see page 7/31 onwards.

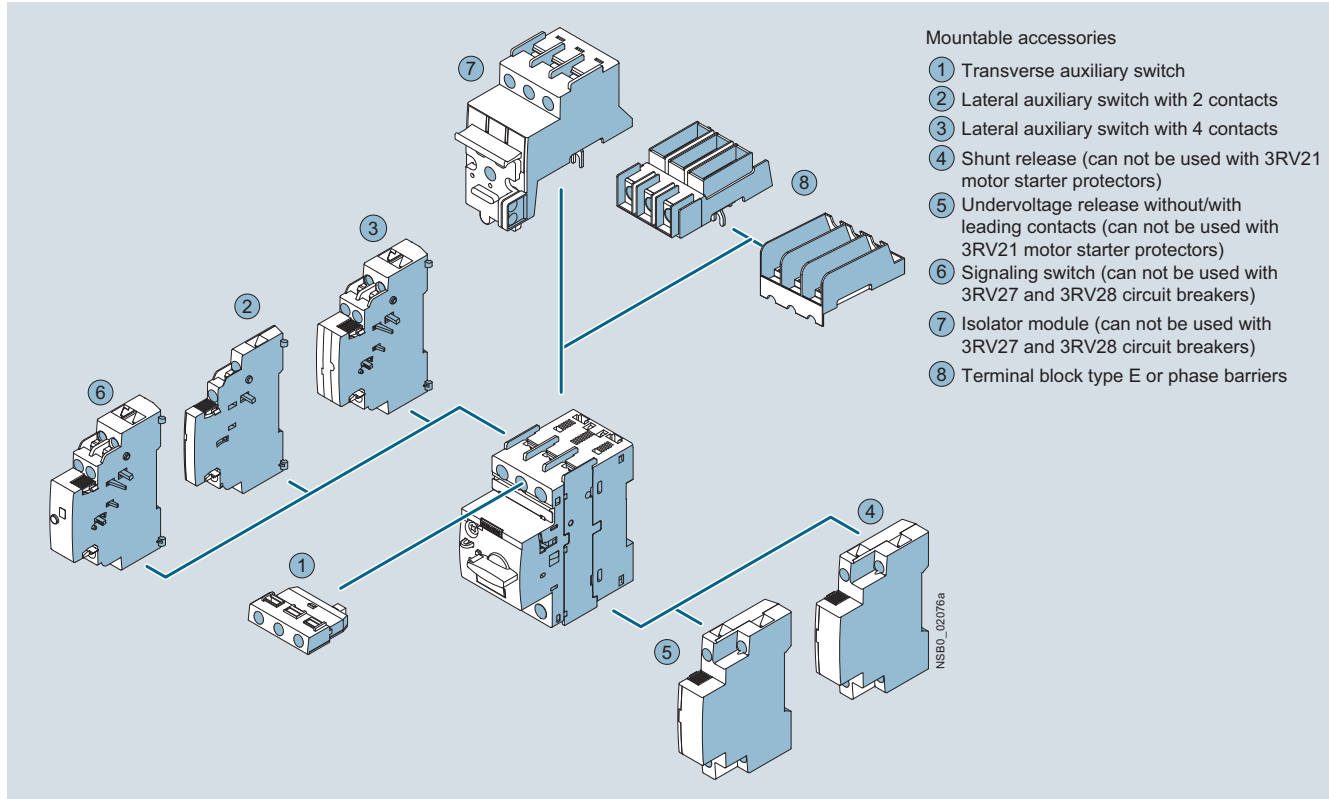

Mountable accessories for SIRIUS 3RV2 motor starter protectors/circuit breakers



SIRIUS motor starter protector with spring-type terminals, size S0 (left) and SIRIUS motor starter protector with screw terminals, size S00 (right)

The new SIRIUS 3RV2 motor starter protectors/circuit breakers are compact, current limiting motor starter protectors/circuit breakers which are optimized for load feeders. The motor starter protectors/circuit breakers are used for switching and protecting three-phase motors of up to 37 kW at 400 V AC and for other loads with rated currents of up to 80 A.

For 3RV1 motor starter protectors/circuit breakers in size S3 up to 100 A, see page 7/63 onwards.

The new 3RV2 motor starter protectors/circuit breakers are usually approved according to IEC and UL/CSA. According to UL 508/UL 60947-4-1, the 3RV2 motor starter protectors in sizes S00 to S2 are approved as:

- "Manual Motor Controllers"
- "Manual Motor Controllers" for "Group Installations"
- "Manual Motor Controllers Suitable for Tab Conductor Protection in Group Installations"
- "Self-Protected Combination Motor Controllers (Type E)"
Please note that for this approval the 3RV20 motor starter protectors must be equipped with additional infeed terminals or phase barriers. More information, see "Accessories" on page 7/38.

Corresponding short-circuit values, see pages 7/10 to 7/15.

The 3RV27 and 3RV28 circuit breakers are approved as circuit breakers according to UL 489; they are a special version of the 3RV2 motor starter protectors.

Motor Starter Protectors/Circuit Breakers

SIRIUS 3RV2 Motor Starter Protectors/Circuit Breakers up to 80 A

General data

Type of construction

The 3RV2 motor starter protectors are available in three sizes:

- Size S00 – width 45 mm, max. rated current 16 A, at 400 V AC suitable for three-phase motors up to 7.5 kW
- Size S0 – width 45 mm, max. rated current 40 A, at 400 V AC suitable for three-phase motors up to 18.5 kW
- Size S2 – width 55 mm, max. rated current 80 A, at 400 V AC suitable for three-phase motors up to 37 kW

Size S3 of the 3RV1 motor starter protectors up to 100 A, see page 7/63 onwards.

Circuit breakers acc. to UL 489



The 3RV27 and 3RV28 circuit breakers are available in two sizes:

- Size S00 – width 45 mm, max. rated current 15 A, for 480 Y/277 V AC
- For size S0 – width 45 mm, max. rated current 22 A, at 480 Y/277 V AC

For size S3 of the 3RV1742 circuit breakers up to 70 A, see page 7/67.

Connection methods

The 3RV2 motor starter protectors/circuit breakers can be supplied with screw terminals, spring-type terminals and ring cable lug connections.

-  Screw terminals
-  Spring-type terminals
-  Ring terminal lug connections

The terminals are indicated in the corresponding tables by the symbols shown on orange backgrounds.

"Increased safety" type of protection EEx e according to ATEX directive 94/9/EC

3RV20 motor starter protectors are suitable for overload protection of explosion-proof motors with "increased safety" type of protection EEx e.

EC type test certificate for Category (2) G/D has been submitted. More details on request.

Comprehensive technical information, see [manuals/operating instructions, http://support.automation.siemens.com/WW/view/en/20357458/133300](http://support.automation.siemens.com/WW/view/en/20357458/133300).

Article No. scheme

Digit of the Article No.	1st - 3rd	4th	5th	6th	7th	8th	9th	10th	11th	12th	13th	14th	15th	16th
Motor starter protectors/ circuit breakers	□□□	□	□	□	□	-	□	□	□	□	-	□	□	□
SIRIUS 2nd generation	3 R V		2											
Type of motor starter protector/ circuit breaker			□											
Size				□										
Breaking capacity					□									
Setting range for overload release							□	□						
Trip class (CLASS)									□					
Connection methods										□				
With or without auxiliary switch											□			
Special versions												□	□	□
Example	3 R V	2	0	1	1	-	1	A	A	1	0			

Note:

The Article No. scheme is presented here merely for information purposes and for better understanding of the logic behind the article numbers.

For your orders, please use the article numbers quoted in the catalog in the Selection and ordering data.

Motor Starter Protectors/Circuit Breakers

SIRIUS 3RV2 Motor Starter Protectors/Circuit Breakers up to 80 A

General data

Benefits

Advantages through energy efficiency

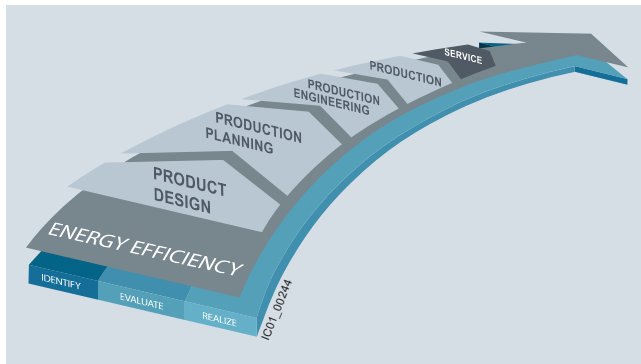

Overview of the energy management process

We offer you a unique portfolio for industrial energy management, using an energy management system that helps to optimally define your energy needs. We split up our industrial energy management into three phases – identify, evaluate and realize – and we support you with the appropriate hardware and software solutions in every process phase.

The innovative products of the SIRIUS industrial controls portfolio can also make a substantial contribution to a plant's energy efficiency (see www.siemens.com/sirius/energysaving).

3RV2 motor starter protectors/circuit breaker contribute to energy efficiency throughout the plant as follows:

- Minimization of energy losses through optimization of the bimetal trip units
- Reduction of inherent power loss
- Less heating of the control cabinet
- Smaller control cabinet air conditioners can be used

Application

Operating conditions

3RV2 motor starter protectors/circuit breakers are suitable for use in any climate. They are intended for use in enclosed rooms in which no severe operating conditions (such as dust, caustic vapors, hazardous gases) prevail. When installed in dusty and damp areas, suitable enclosures must be provided.

3RV2 motor starter protectors/circuit breakers can optionally be fed from the top or from below.

The permissible ambient temperatures, the maximum switching capacities, the tripping currents and other boundary conditions can be found in the technical specifications and tripping characteristics, see the manual

"SIRIUS Innovations – SIRIUS 3RV2 Motor Starter Protectors", <http://support.automation.siemens.com/WW/view/en/60279172>.

3RV2 motor starter protectors/circuit breakers are suitable for operation in IT systems (IT networks). In this case, the different short-circuit breaking capacity in the IT system must be taken into account, see page 7/11.

Since operational currents, starting currents and current peaks are different even for motors with identical power ratings due to the inrush current, the motor ratings in the selection tables are only guide values. The specific rated and startup data of the motor to be protected is always paramount to the choice of the most suitable motor starter protector/circuit breaker. This also applies to motor starter protectors for transformer protection.

Note:

For the use of 3RV2 motor starter protectors in conjunction with highly energy-efficient IE3 motors, please observe the information on dimensioning and configuring, see "Configuration Manual for SIRIUS Controls with IE3 Motors", <http://support.automation.siemens.com/WW/view/en/94770820>.

More information, see 1/3.

Possible uses

The 3RV2 motor starter protectors can be used:

- For short-circuit protection
- For motor protection (also with overload relay function)
- For system protection
- For short-circuit protection for starter combinations
- For transformer protection
- As main and EMERGENCY-STOP switches
- For operation in IT systems (IT networks)
- For switching of DC currents
- In areas subject to explosion hazard (ATEX)
- Approved as circuit breakers according to UL 489 (3RV27 and 3RV28)

For more information, see

- System manual "SIRIUS Innovations – System Overview", <http://support.automation.siemens.com/WW/view/en/60311318>
- Manual "SIRIUS Innovations – SIRIUS 3RV2 Motor Starter Protectors", <http://support.automation.siemens.com/WW/view/en/60279172>

Motor Starter Protectors/Circuit Breakers

SIRIUS 3RV2 Motor Starter Protectors/Circuit Breakers up to 80 A

General data

Technical specifications

Short-circuit breaking capacity I_{cu} , I_{cs} according to IEC 60947-2

This table shows the rated ultimate short-circuit breaking capacity I_{cu} and the rated service short-circuit breaking capacity I_{cs} of the 3RV2 motor starter protectors/circuit breakers with different operating voltages dependent on the rated current I_n of the motor starter protectors/circuit breakers.

Power can be supplied to the motor starter protectors/circuit breakers via the terminals at the top or at the bottom without restricting the rated data. If the short-circuit current at the place of installation exceeds the rated short-circuit breaking capacity of the motor starter protector/circuit breaker as specified in the table, a back-up fuse is required. It is also possible to install an upstream motor starter protector/circuit breaker with a limiter function.

The maximum rated current of this back-up fuse is indicated in the tables. The rated ultimate short-circuit breaking capacity then applies as specified on the fuse.

Fuseless design

Motor starter protector/contactors assemblies for short-circuit currents up to 150 kA can be ordered as fuseless load feeders, see Chapter 8 "Load Feeders and Motor Starters for Use in the Control Cabinet".

Motor starter protectors/circuit breakers	Rated current I_n	Up to 240 V AC ¹⁾			Up to 400 V AC ^{1)/} 415 V AC ²⁾			Up to 440 V AC ^{1)/} 460 V AC ²⁾			Up to 500 V AC ^{1)/} 525 V AC ²⁾			Up to 690 V AC ¹⁾		
		I_{cu}	I_{cs}	Max. fuse (gG)	I_{cu}	I_{cs}	Max. fuse (gG) ³⁾	I_{cu}	I_{cs}	Max. fuse (gG) ³⁾	I_{cu}	I_{cs}	Max. fuse (gG) ³⁾	I_{cu}	I_{cs}	Max. fuse (gG) ³⁾⁴⁾
Type	A	kA	kA	A	kA	kA	A	kA	kA	A	kA	kA	A	kA	kA	A
Size S00																
3RV2.11	0.16 ... 1.6	100	100	°	100	100	°	100	100	°	100	100	°	100	100	°
	2; 2.5	100	100	°	100	100	°	100	100	°	100	100	°	10	10	25
	3.2	100	100	°	100	100	°	100	100	°	100	100	°	10	10	32
	4; 5	100	100	°	100	100	°	100	100	°	100	100	°	6	4	32
	6.3	100	100	°	100	100	°	100	100	°	100	100	°	6	4	50
	8	100	100	°	100	100	°	50	50	63	42	42	63	6	4	50
	10	100	100	°	100	100	°	50	50	80	42	42	63	6	4	50
	12.5	100	100	°	100	100	°	50	50	80	42	42	80	6	4	63
16	100	100	°	55	30	100	50	10	80	10	5	80	4	4	63	
Size S0																
3RV2.21	0.16 ... 1.6	100	100	°	100	100	°	100	100	°	100	100	°	100	100	°
	2; 2.5	100	100	°	100	100	°	100	100	°	100	100	°	10	10	25
	3.2	100	100	°	100	100	°	100	100	°	100	100	°	10	10	32
	4; 5	100	100	°	100	100	°	100	100	°	100	100	°	6	4	32
	6.3	100	100	°	100	100	°	100	100	°	100	100	°	6	4	50
	8	100	100	°	100	100	°	50	50	63	42	42	63	6	4	50
	10	100	100	°	100	100	°	50	50	80	42	42	63	6	4	50
	12.5	100	100	°	100	100	°	50	50	80	42	42	80	6	4	63
	16	100	100	°	55	25	100	50	10	80	10	5	80	4	2	63
	20	100	100	°	55	25	125	50	10	80	10	5	80	4	2	63
	22; 25	100	100	°	55	25	125	50	10	100	10	5	80	4	2	63
28; 32	100	100	°	55	25	125	30	10	125	10	5	100	4	2	100	
36; 40	100	100	°	20	10	125	12	8	125	6	3	100	3	2	100	
Size S2																
3RV2.31	14; 17	100	100	°	65	30	100	50	25	100	12	6	63	5	3	63
	20	100	100	°	65	30	100	50	25	100	12	6	80	5	3	80
	25	100	100	°	65	30	100	50	15	100	12	6	80	5	3	80
	32; 36	100	100	°	65	30	125	50	15	125	10	5	100	4	2	100
	40; 45	100	100	°	65	30	160	50	15	125	10	5	100	4	2	100
	52	100	100	°	65	30	160	50	15	125	10	5	125	4	2	125
59 ... 80	Values on request															
Size S2, with increased switching capacity																
3RV2.32	14; 17	100	100	°	100	50	°	65	30	100	18	10	63	8	5	63
	20; 25	100	100	°	100	50	°	65	30	100	18	10	80	8	5	80
	32 ... 45	100	100	°	100	50	°	65	30	125	15	8	100	6	4	100
	52	100	100	°	100	50	°	65	30	125	15	8	125	6	4	125
59 ... 80	Values on request															

° No back-up fuse required, since short-circuit resistant up to 100 kA

1) 10 % overvoltage.

2) 5 % overvoltage.

3) Back-up fuse only required if short-circuit current at the place of installation $> I_{cu}$.

4) Alternatively, fuseless limiter combinations for 690 V AC can also be used.

Motor Starter Protectors/Circuit Breakers

SIRIUS 3RV2 Motor Starter Protectors/Circuit Breakers up to 80 A

General data

Short-circuit breaking capacity I_{cuIT} in the IT system (IT network) according to IEC 60947-2

3RV2 motor starter protectors/circuit breakers are suitable for use in IT systems. The values of I_{cu} and I_{cs} apply for the three-pole short circuit. In case of a double ground fault in different phases at the input and output side of a motor starter protector, the special short-circuit breaking capacity I_{cuIT} applies. The specifications in the table below apply to 3RV2 motor starter protectors/circuit breakers.

If the short-circuit current at the place of installation exceeds the motor starter protector/circuit breaker's specified rated short-circuit breaking capacity, you will need to use a back-up fuse. The maximum rated current of this back-up fuse is indicated in the tables. The rated short-circuit breaking capacity then applies as specified on the fuse.

Motor starter protectors	Rated current I_n	Up to 240 V AC ¹⁾		Up to 400 V AC ¹⁾ /415 V AC ²⁾		Up to 500 V AC ¹⁾ /525 V AC ²⁾		Up to 690 V AC ¹⁾⁵⁾	
		I_{cuIT}	Max. fuse (gG) ³⁾	I_{cuIT}	Max. fuse (gG) ³⁾⁴⁾	I_{cuIT}	Max. fuse (gG) ³⁾	I_{cuIT}	Max. fuse (gG) ³⁾
Type	A	kA	A	kA	A	kA	A	kA	A
Size S00									
3RV2.11	0.16 ... 0.4	100	°	100	°	100	°	100	°
	0.5	100	°	100	°	100	°	0.5	4
	0.63; 0.8	100	°	100	°	100	°	0.5	6
	1	100	°	100	°	8	10	2	10
	1.25	100	°	100	°	8	16	2	16
	1.6	100	°	100	°	8	20	2	16
	2; 2.5	100	°	8	25	8	25	2	20
	3.2	100	°	8	32	8	32	2	25
	4; 5	100	°	4	32	2	32	2	25
	6.3; 8	100	°	4	50	2	40	1.5	35
	10	100	°	4	50	2	40	1.5	40
	12.5	100	°	4	63	2	50	1.5	40
	16	55	80	4	63	2	50	1.5	40
Size S0									
3RV2.11	0.16 ... 0.4	100	°	100	°	100	°	100	°
	0.5	100	°	100	°	100	°	0.5	4
	0.63; 0.8	100	°	100	°	100	°	0.5	6
	1	100	°	100	°	8	10	2	10
	1.25	100	°	100	°	8	16	2	16
	1.6	100	°	100	°	8	20	2	16
	2; 2.5	100	°	8	25	8	25	2	20
	3.2	100	°	8	32	8	32	2	25
	4; 5	100	°	4	32	2	32	2	25
	6.3; 8	100	°	4	50	2	40	1.5	35
	10	100	°	4	50	2	40	1.5	40
	12.5	100	°	4	63	2	50	1.5	40
	16	55	80	4	63	2	50	1.5	40
	20 ... 25	55	80	4	63	2	50	1.5	50
	28; 32	55	80	2	63	2	63	1.5	63
	36; 40	20	80	2	63	2	63	1.5	63
Size S2									
3RV2.31	14 ... 25	100	°	8	100	6	80	4	63
	32 ... 45	100	°	6	125	4	100	3	80
	52	100	°	4	160	3	125	2	100
	59 ... 80	Values on request							
Size S2, with increased switching capacity									
3RV2.32	14 ... 25	100	°	8	100	6	80	4	63
	32 ... 45	100	°	6	125	6	100	4	80
	52	100	°	6	160	6	125	4	100
	59 ... 80	Values on request							

° No back-up fuse required, since short-circuit resistant up to 100 kA

1) 10 % overvoltage.

2) 5 % overvoltage.

3) Back-up fuse only required if short-circuit current at the place of installation $> I_{cuIT}$.

4) Alternatively, fuseless limiter combinations for 690 V AC can also be used.

5) Overvoltage category II applies for applications in IT systems > 600 V.

Motor Starter Protectors/Circuit Breakers

SIRIUS 3RV2 Motor Starter Protectors/Circuit Breakers up to 80 A

General data

Limiting function with standard devices for 500 V AC and 690 V AC according to IEC 60947-2

The table shows the rated ultimate short-circuit breaking capacity I_{cu} and the rated service short-circuit breaking capacity I_{cs} with an upstream standard motor starter protector/circuit breaker that fulfills the limiter function at voltages 500 V AC and 690 V AC.

The short-circuit breaking capacity can be increased significantly with an upstream standard motor starter protector/circuit breaker with limiter function. The motor starter protector/circuit breaker which is connected downstream must be set to the rated current of the load.

With motor starter protector/circuit breaker assemblies, note the clearance to grounded parts and between the motor starter protectors/circuit breaker. Short-circuit proof wiring between the motor starter protectors/circuit breaker must be ensured. The motor starter protectors/circuit breakers can be mounted side by side in a modular arrangement.

Standard motor starter protectors/circuit breakers		Rated current I_n A	Up to 500 V AC ¹⁾ /525 V AC ²⁾		Up to 690 V AC ¹⁾	
Type	With limiter rated current I_n Type		I_{cu} kA	I_{cs} kA	I_{cu} kA	I_{cs} kA
Size S00						
3RV2011	Size S0: $I_n = 32$ A	2 ... 6.3 8 10 ... 16	-- 100 100	-- 50 50	50 20 20 ³⁾	25 10 10 ³⁾
	Size S2: 3RV1331-4HC10 $I_n = 50$ A	10 ... 16	--	--	50	25
Size S0						
3RV2021	Size S0: $I_n = 32$ A	16 ... 32	100	50	20 ³⁾	10 ³⁾
	Size S2: 3RV1331-4HC10 $I_n = 50$ A	16 ... 32	--	--	50	20
Size S2						
3RV2031		14 ... 80	Values on request			
Size S2, with increased switching capacity						
3RV2032		14... 80	Values on request			

-- No limiter required

1) 10 % overvoltage.

2) 5 % overvoltage.

3) Infeed to the limiter is always on the side 1L1/3L2/5L3.

Motor Starter Protectors/Circuit Breakers

SIRIUS 3RV2 Motor Starter Protectors/Circuit Breakers up to 80 A

General data

Permissible rated data of approved devices for North America (UL/CSA)

Motor starter protectors of the 3RV2 series are approved for UL/CSA, and according to UL508/UL 60947-4-1 and CSA C22.2 No. 14/CSA C22.2 No. 60947-4-1 they can be used on their own or as load feeders in combination with a contactor.

These motor starter protectors/circuit breakers can be used as "Manual Motor Controllers" for "Group Installations", as "Manual Motor Controllers Suitable for Tap Conductor Protection in Group Installations" and as "Self-Protected Combination Motor Controllers" (Type E).

3RV2 motor starter protectors as "Manual Motor Controllers"

If used as a "Manual Motor Controller", the motor starter protector is always operated in combination with an upstream short-circuit protection device. Approved fuses or a circuit breaker according to UL 489/CSA C22.2 No. 5 can be used. These devices must be dimensioned according to the National Electrical Code (UL) or Canadian Electrical Code (CSA).

The file numbers for the approval of the 3RV2 as a Manual Motor Controller are as follows:

- UL File No. 47705, CCN: NLRV
- CSA Master Contract 165071, Product Class: 3211 05

Motor starter protectors	hp rating ¹⁾ for FLA ²⁾ max.		Rated current I_n A	240 V AC		480 V AC		600 V AC	
	Single-phase	Three-phase		UL $I_{bc}^{(3)}$ kA	CSA $I_{bc}^{(3)}$ kA	UL $I_{bc}^{(3)}$ kA	CSA $I_{bc}^{(3)}$ kA	UL $I_{bc}^{(3)}$ kA	CSA $I_{bc}^{(3)}$ kA
Size S00									
3RV2011, 3RV2111, 3RV2311, 3RV2411			0.16 ... 12.5 16	65 65	65 65	65 65	65 65	30 --	30 --
FLA ²⁾ max.	115	1	2						
16 A, 480 V;	200	2	3						
12.5 A, 600 V	230	2	5						
	460	--	10						
	575/600	--	10						
Size S0									
3RV2021, 3RV2121, 3RV2321, 3RV2421			0.16 ... 12.5 16 ... 25 28, 32 36, 40	65 65 65 65	65 65 65 65	65 65 50 12	65 65 50 12	30 --/(30) ⁴⁾ -- --	30 --/(30) ⁴⁾ -- --
FLA ²⁾ max.	115	3	5						
40 A, 480 V	200	5	10						
	230	7 1/2	10						
	460	--	30						
	575/600	--	--						
Size S2									
3RV2031, 3RV2032, 3RV2131, 3RV2331, 3RV2332, 3RV2431				Values on request					

-- No approval

¹⁾ hp rating = Power rating in horse power (maximum motor rating).

²⁾ FLA = Full Load Amps/motor full load current.

³⁾ Corresponds to "short-circuit breaking capacity" according to UL/CSA.

⁴⁾ The values in brackets only apply to 3RV2.23 motor starter protectors.

Motor Starter Protectors/Circuit Breakers

SIRIUS 3RV2 Motor Starter Protectors/Circuit Breakers up to 80 A

General data

3RV20 motor starter protectors (up to 80 A) as "Manual Motor Controller Suitable for Tap Conductor Protection in Group Installations"

The application as "Manual Motor Controllers Suitable for Tap Conductor Protection in Group Installations" is only available for UL. CSA does not recognize this approval! When the motor starter protector is used as a "Manual Motor Controller Suitable for Tap Conductor Protection in Group Installations", it must always be combined with upstream short-circuit protection. Approved fuses or a circuit breaker according to UL 489 can be used. These devices must be dimensioned according to the National Electrical Code.

The 3RV20 motor starter protectors are approved as "Manual Motor Controllers Suitable for Tap Conductor Protection in Group Installations" under the following file number:

- UL File No. 47705, CCN: NLRV

Motor starter protectors	V	hp rating ¹⁾ for FLA ²⁾ max.		Rated current I_n A	240 V AC	Up to 480 Y/277 V AC	Up to 600 Y/347 V AC
		Single-phase	Three-phase		UL I_{bc} ³⁾ kA	UL I_{bc} ³⁾ kA	UL I_{bc} ³⁾ kA
Size S00							
3RV2011				0.16 ... 12.5 16	65 65	65 65	30 --
FLA ²⁾ max.	115	1	2				
16 A, 480 V;	200	2	3				
12.5 A, 600 V	230	2	5				
	460	--	10				
	575/600	--	10				
Size S0							
3RV2021				0.16 ... 12.5 16 ... 25 28; 32	65 65 50	65 65 50	30 -- --
FLA ²⁾ max.	115	2	5				
32 A, 480 V	200	3	7 1/2				
	230	5	10				
	460	--	20				
	575/600	--	--				
Size S2							
3RV2031, 3RV2032					Values on request		

-- No approval

¹⁾ hp rating = Power rating in horse power (maximum motor rating).

²⁾ FLA = Full Load Amps/motor full load current.

³⁾ Corresponds to "short-circuit breaking capacity" according to UL.

Motor Starter Protectors/Circuit Breakers

SIRIUS 3RV2 Motor Starter Protectors/Circuit Breakers up to 80 A

General data

3RV20 motor starter protectors (up to 80 A) as "Self-Protected Combination Motor Controller (Type E)"

UL 508/UL 60947-4-1 approval demands 1-inch clearance and 2-inch creepage distance at line side for "Self-Protected Combination Motor Controller Type E".

Therefore, 3RV20 motor starter protectors of sizes S00 to S2 are approved according to UL 508/UL 60947-4-1 in combination with the terminal blocks listed below.

CSA does not require these extended clearances and creepage distances. According to CSA, these terminal blocks can be omitted when the device is used as a "Self-Protected Combination Motor Controller".

The 3RV20 motor starter protectors are approved as "Self-Protected Combination Motor Controllers" under the following file numbers:

- UL File No. E156943, CCN: NKJH
- CSA Master Contract 165071, Product Class: 3211 08

Motor starter protectors		hp rating ¹⁾ for FLA ²⁾ max.		Rated current I_n	Up to 240 V AC		Up to 480 Y/277 V AC		Up to 600 Y/347 V AC	
					UL $I_{bc}^{(3)}$	CSA $I_{bc}^{(3)}$	UL $I_{bc}^{(3)}$	CSA $I_{bc}^{(3)}$	UL $I_{bc}^{(3)}$	CSA $I_{bc}^{(3)}$
Type	V	Single-phase	Three-phase	A	kA	kA	kA	kA	kA	kA
Size S00										
3RV2011 + 3RV2928-1H⁴⁾5)				0.16 ... 12.5	65	65	65	65	30	30
FLA ²⁾ max.	115	1	2	16	65	65	65	65	--	--
16 A, 480 V;	200	2	3							
12.5 A, 600 V	230	2	5							
	460	--	10							
	575/600	--	10							
Size S0										
3RV2021 + 3RV2928-1H⁴⁾5)				0.16 ... 12.5	65	65	65	65	30	30
FLA ²⁾ max.	115	2	5	16 ... 25	65	65	65	65	--	--
32 A, 480 V	200	3	7 1/2	28; 32	50	50	50	50	--	--
	230	5	10							
	460	--	20							
	575/600	--	--							
Size S2										
3RV2031/3RV2032 + 3RV2938-1K⁴⁾					Values on request					

-- No approval

¹⁾ hp rating = Power rating in horse power (maximum motor rating).

²⁾ FLA = Full Load Amps/motor full load current.

³⁾ Corresponds to "short-circuit breaking capacity" according to UL/CSA.

⁴⁾ Not required for CSA.

⁵⁾ Alternatively, the 3RV2928-1K phase barrier can also be used.

3RV27 and 3RV28 motor starter protectors as "circuit breakers"

These motor starter protectors are approved as circuit breakers according to UL 489 and CSA 22.2 No. 5. They can be used therefore as upstream short-circuit protective devices for "Manual Motor Controllers" and "Manual Motor Controllers Suitable for Tap Conductor Protection in Group Installations".

3RV27 and 3RV28 motor starter protectors are approved as "circuit breakers" under the following file numbers:

- UL File No. E235044, CCN: DIVQ
- CSA Master Contract 165071, Product Class: 1432 01

Circuit breakers	Rated current I_n	240 V AC		480 Y/277 V AC		600 Y/347 V AC	
		UL $I_{bc}^{(1)}$	CSA $I_{bc}^{(1)}$	UL $I_{bc}^{(1)}$	CSA $I_{bc}^{(1)}$	UL $I_{bc}^{(1)}$	CSA $I_{bc}^{(1)}$
Type	A	kA	kA	kA	kA	kA	kA
Size S00							
3RV2711	0.16 ... 12.5	65	65	65	65	10	10
	15	65	65	65	65	--	--
3RV2811	0.16 ... 12.5	65	65	65	65	10	10
	15	65	65	65	65	--	--
Size S0							
3RV2721	20; 22	50	50	50	50	--	--
3RV2821	20; 22	50	50	50	50	--	--

-- No approval

¹⁾ Corresponds to "short-circuit breaking capacity" according to UL.

Motor Starter Protectors/Circuit Breakers

SIRIUS 3RV2 Motor Starter Protectors/Circuit Breakers up to 80 A

General data

General data		3RV2.1.	3RV2.2.	3RV2.3.	3RV27, 3RV28
Type		S00	S0	S2	S00, S0
Size					
Dimensions (W x H x D)		45 x 97 x 91	45 x 97 x 91	55 x 140 x 149	45 x 144 x 92
• Screw terminals		45 x 106 x 91	45 x 119 x 91	--	--
• Spring-type terminals					
Standards		Yes		Yes	--
• IEC 60947-1, EN 60947-1 (VDE 0660 Part 100)		Yes		Yes	--
• IEC 60947-2, EN 60947-2 (VDE 0660 Part 101)		Yes	Yes	Yes	--
• IEC 60947-4-1, EN 60947-4-1 (VDE 0660 Part 102)		Yes	Yes	Yes	--
• UL 508/UL 60947-4-1, CSA C22.2 No. 14/CSA C22.2 No. 60947-4-1		Yes	Yes	Yes	Yes
• UL 489, CSA C22.2 No. 5		--	--	--	Yes
Number of poles		3			
Max. rated current I_n max (= max. rated operational current I_e)	A	16	40	80	22
Permissible ambient temperature					
• Storage/transport		-50 ... +80			
• Operation		-20 ... +70			
	I_n : 0.16 ... 32 A	(current reduction above +60 °C)		--	
	I_n : 36 ... 40 A	--	-20 ... +40	--	
			(the devices must not be mounted side-by-side and they must not be assembled with link modules with contactors. A lateral clearance of 9 mm is required.)		
	I_n : 14 ... 80 A	--		-20 ... +70	--
				(current reduction above +60 °C)	
Permissible rated current at inside temperature of control cabinet					
• +60 °C	%	100			
• +70 °C	%	87			
Permissible rated current at ambient temperature of enclosure (applies for motor starter protector/circuit breaker inside enclosure ≤ 32 A)					
• +35 °C	%	100		On request	100
• +60 °C	%	87			87
Rated operational voltage U_e					
• Acc. to IEC	V AC	690 (when a molded-plastic enclosure is used only 500 V)			
• Acc. to UL/CSA	V AC	600			
Rated frequency	Hz	50/60			
Rated insulation voltage U_i	V	690			
Rated impulse withstand voltage U_{imp}	kV	6			
Utilization category					
• IEC 60947-2 (motor starter protector/circuit breaker)	A	AC-3			
• IEC 60947-4-1 (motor starter)					
Trip class CLASS	Acc. to IEC 60947-4-1	10		10/20	--
DC short-circuit breaking capacity (time constant $t = 5$ ms)					
• 1 conducting path 150 V DC	kA	10		On request	10
• 2 conducting paths in series 300 V DC	kA	10			10
• 3 conducting paths in series 450 V DC	kA	10			10
Power loss P_V for each motor starter protector/circuit breaker					
Dependent on the rated current I_n (upper setting range)					
	I_n : 0.16 ... 0.63 A	W	5	--	5
	I_n : 0.8 ... 6.3 A	W	6	--	6
	I_n : 8 ... 16 A	W	7	--	7
	I_n : 16 A	W	--	7	10
	I_n : 17 ... 25 A	W	--	8	12
	I_n : 28 ... 32 A	W	--	11	14
	I_n : 36 ... 40 A	W	--	14	15
	I_n : 45 ... 52 A	W	--	--	17
	I_n : ... 80 A	W	--	--	On request
$R_{per\ conducting\ path} = \frac{P}{I^2 \times 3}$					
Shock resistance	Acc. to IEC 60068-2-27	g/ms	25/11 (square and sine pulse)		
Degree of protection	Acc. to IEC 60529		IP20		
Touch protection	Acc. to EN 50274		Finger-safe for vertical contact from the front		
Temperature compensation	Acc. to IEC 60947-4-1	°C	-20 ... +60		
Phase failure sensitivity	Acc. to IEC 60947-4-1		Yes (only for 3RV23 motor starter protectors)		No
Explosion protection – Safe operation of motors with "increased safety" type of protection			Yes (only for 3RV20 motor starter protectors)		
EC type test certificate number according to directive 94/9/EC (ATEX)			DMT 02 ATEX F 001  II (2) GD	On request	No

Motor Starter Protectors/Circuit Breakers

SIRIUS 3RV2 Motor Starter Protectors/Circuit Breakers up to 80 A

General data

General data (continued)

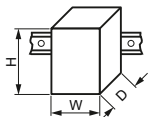
General data (continued)		3RV2.1.	3RV2.2.	3RV2.3.	3RV27, 3RV28
Type		S00	S0	S2	S00, S0
Size		45 x 97 x 91	45 x 97 x 91	55 x 140 x 149	45 x 144 x 92
Dimensions (W x H x D)		45 x 106 x 91	45 x 119 x 91	--	--
<ul style="list-style-type: none"> • Screw terminals • Spring-type terminals 					
Isolating function	Acc. to IEC 60947-2	Yes			
Main and EMERGENCY-STOP switch characteristics	Acc. to DIN EN 60204-1	Yes			
(with corresponding accessories)					
Protective separation between main and auxiliary circuits, required for PELV applications	Acc. to IEC 60947-1				
<ul style="list-style-type: none"> • Up to 400 V +10 % • Up to 415 V +5 % (higher voltages on request) 		Yes			
		Yes			
Permissible mounting position		Any, acc. to IEC 60447 start command "I" right-hand side or top			
Mechanical endurance	Operating cycles	100 000		52 A: 50 000, 80 A: On request	100 000
Electrical endurance	Operating cycles	100 000		52 A: 50 000, 80 A: On request	100 000
Max. switching frequency per hour (motor starts)	1/h	15			

Rated data of the auxiliary switches and signaling switches

		Lateral auxiliary switch with 1 NO + 1 NC, 2 NO, 2 NC, 2 NO + 2 NC	Signaling switches	Transverse auxiliary switch with 1 CO	1 NO + 1 NC, 2 NO
Max. rated voltage					
• Acc. to NEMA (UL)	V AC	600			250
• Acc. to NEMA (CSA)	V AC	600			250
Uninterrupted current	A	10		5	2.5
Switching capacity		1 NO + 1 NC, 2 NO, 2 NC; A600, Q300; 2 NO + 2 NC; A300, Q300	A600, Q300	B600, R300	C300, R300

Front transverse auxiliary switches

		Switching capacity for different voltages	
		1 CO	1 NO + 1 NC, 2 NO
Rated operational current I_e			
• At AC-15, alternating voltage			
- 24 V	A	4	2
- 230 V	A	3	0.5
• At AC-12 = I_{th} , alternating voltage			
- 24 V	A	10	2.5
- 230 V	A	10	2.5
• At DC-13, direct voltage L/R 200 ms			
- 24 V	A	1	1
- 48 V	A	--	0.3
- 60 V	A	--	0.15
- 110 V	A	0.22	--
- 220 V	A	0.1	--
Minimum load capacity	V mA	17 1	

Front transverse solid-state compatible auxiliary switches

		Switching capacity for different voltages	
		1 CO	
Rated operational voltage U_e	Alternating voltage	V	125
Rated operational current $I_e/AC-14$	at $U_e = 125$ V	A	0.1
Rated operational voltage U_e	Direct voltage L/R 200 ms	V	60
Rated operational current $I_e/DC-13$	at $U_e = 60$ V	A	0.3
Minimum load capacity	V mA	5 1	

Motor Starter Protectors/Circuit Breakers

SIRIUS 3RV2 Motor Starter Protectors/Circuit Breakers up to 80 A



General data

Lateral auxiliary switches with signaling switch			
Switching capacity for different voltages: Lateral auxiliary switch with 1 NO + 1 NC, 2 NO, 2 NC, 2 NO + 2 NC Signaling switch			
Rated operational current I_e			
• At AC-15, alternating voltage			
- 24 V	A	6	
- 230 V	A	4	
- 400 V	A	3	
- 690 V	A	1	
• At AC-12 = I_{th} , alternating voltage			
- 24 V	A	10	
- 230 V	A	10	
- 400 V	A	10	
- 690 V	A	10	
• At DC-13, direct voltage L/R 200 ms			
- 24 V	A	2	
- 110 V	A	0.5	
- 220 V	A	0.25	
- 440 V	A	0.1	
Minimum load capacity	V	17	
	mA	1	
Auxiliary releases			
		Undervoltage releases	Shunt releases
Power consumption			
• During pick-up			
- AC voltages	VA/W	20.2/13	20.2/13
- DC voltages	W	20	13 ... 80
• During uninterrupted duty			
- AC voltages	VA/W	7.2/2.4	--
- DC voltages	W	2.1	--
Response voltage			
• Tripping	V	0.35 ... 0.7 x U_s	0.7 ... 1.1 x U_s
• Pick-up	V	0.85 ... 1.1 x U_s	--
Opening time maximum	ms	20	
Short-circuit protection for auxiliary and control circuits			
Melting fuses operational class gG	A	10	
Miniature circuit breakers C characteristic	A	6 (prospective short-circuit current < 0.4 kA)	

Motor Starter Protectors/Circuit Breakers

SIRIUS 3RV2 Motor Starter Protectors/Circuit Breakers up to 80 A

General data

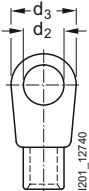
Conductor cross-sections of main circuit						
Type		3RV2.11	3RV2.21	3RV2.31-4B1., 3RV2.31-4D.1., 3RV2.31-4E.1., 3RV2.31-4P.1., 3RV2.31-4S.1., 3RV2.31-4T.1., 3RV2.31-4U.1., 3RV2.31-4V.1.	3RV2.31-4J.1., 3RV2.31-4K.1., 3RV2.31-4R.1., 3RV2.31-4W.1., 3RV2.31-4X.1., 3RV2431-4VA1., 3RV2.32	3RV27, 3RV28
Size		S00	S0	S2		S00, S0
Connection type		 Screw terminals				
Terminal screw		M3, Pozidriv size 2	M4, Pozidriv size 2	M6, Pozidriv size 2		M4, Pozidriv size 2
Operating devices	mm	∅ 5 ... 6	∅ 5 ... 6	∅ 5 ... 6		∅ 5 ... 6
Prescribed tightening torque	Nm	0.8 ... 1.2	2 ... 2.5	3.0 ... 4.5		2.5 ... 3
Conductor cross-sections (min./max.), 1 or 2 conductors can be connected						
• Solid or stranded	mm ²	2 x (0.75 ... 2.5) ¹⁾ , 2 x 4	2 x (1 ... 2.5) ¹⁾ , 2 x (2.5 ... 10) ¹⁾	2 x (1 ... 25) ¹⁾ , 1 x (1 ... 35) ¹⁾	2 x (1 ... 35) ¹⁾ , 1 x (1 ... 50) ¹⁾	2 x (1 ... 10) ¹⁾ , max. 1 x 25
• Finely stranded with end sleeve (DIN 46228-1)	mm ²	2 x (0.5 ... 1.5) ¹⁾ , 2 x (0.75 ... 2.5) ¹⁾	2 x (1 ... 2.5) ¹⁾ , 2 x (2.5 ... 6) ¹⁾ , 1 x 10	2 x (1 ... 16) ¹⁾ , 1 x (1 ... 25) ¹⁾	2 x (1 ... 25) ¹⁾ , 1 x (1 ... 35) ¹⁾	1 x (1 ... 16), max. 6 + 16
• AWG cables, solid or stranded	AWG	2 x (20 ... 16) ¹⁾ , 2 x (18 ... 12) ¹⁾	2 x (16 ... 12) ¹⁾ , 2 x (14 ... 8) ¹⁾	2 x (18 ... 3) ¹⁾ , 1 x (18 ... 2) ¹⁾	2 x (18 ... 2) ¹⁾ , 1 x (18 ... 1) ¹⁾	2 x (14 ... 10)
Connection type		 Spring-type terminals				
Operating devices	mm	3.0 x 0.5 and 3.5 x 0.5				
Conductor cross-sections (min./max.), 1 or 2 conductors can be connected						
• Solid or stranded	mm ²	2 x (0.5 ... 4)	2 x (1 ... 10)	--		
• Finely stranded without end sleeve	mm ²	2 x (0.5 ... 2.5)	2 x (1 ... 6)	--		
• Finely stranded with end sleeve (DIN 46228-11)	mm ²	2 x (0.5 ... 2.5)	2 x (1 ... 6)	--		
• AWG cables, solid or stranded	AWG	2 x (20 ... 12)	2 x (18 ... 8)	--		
Max. external diameter of the conductor insulation	mm	3.6	3.6	--		
Connection type		 Ring terminal lug connections				
Terminal screw		M3, Pozidriv size 2	M4, Pozidriv size 2	--		
Operating devices	mm	∅ 5 ... 6	∅ 5 ... 6	--		
Prescribed tightening torque	Nm	0.8 ... 1.2	2 ... 2.5	--		
Usable ring terminal lugs	mm	d ₂ = min. 3.2, d ₃ = max. 7.5	d ₂ = min. 4.3, d ₃ = max. 12.2	--		
<ul style="list-style-type: none"> • DIN 46234 without insulation sleeve • DIN 46225 without insulation sleeve • DIN 46237 with insulation sleeve • JIS C2805 Type R without insulation sleeve • JIS C2805 Type RAV with insulation sleeve • JIS C2805 Type RAP with insulation sleeve 						



¹⁾ If two different conductor cross-sections are connected to one clamping point, both cross-sections must be in the range specified.

Motor Starter Protectors/Circuit Breakers

SIRIUS 3RV2 Motor Starter Protectors/Circuit Breakers up to 80 A

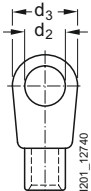

General data

Conductor cross-sections for auxiliary and control circuits

Type	3RV2.11	3RV2.21	3RV2.31, 3RV2.32	3RV27, 3RV28
Size	S00	S0	S2	S00, S0
Connection type	 Screw terminals			
Terminal screw	M3, Pozidriv size 2			
Operating devices	mm	∅ 5 ... 6		
Prescribed tightening torque	Nm	0.8 ... 1.2		
Conductor cross-sections (min./max.) , 1 or 2 conductors can be connected				
• Solid or stranded	mm ²	2 x (0.5 ... 1.5) ¹⁾ , 2 x (0.75 ... 2.5) ¹⁾		
• Finely stranded with end sleeve (DIN 46228-1)	mm ²	2 x (0.5 ... 1.5) ¹⁾ , 2 x (0.75 ... 2.5) ¹⁾		
• AWG cables, solid or stranded	AWG	2 x (18 ... 14) ¹⁾ , 2 x (20 ... 16) ¹⁾		
Connection type	 Spring-type terminals			
Operating devices	mm	3.0 x 0.5 and 3.5 x 0.5		
Conductor cross-sections (min./max.) , 1 or 2 conductors can be connected				
• Solid or stranded	mm ²	2 x (0.5 ... 2.5)		
• Finely stranded without end sleeve	mm ²	2 x (0.5 ... 2.5)		
• Finely stranded with end sleeve (DIN 46228-1)	mm ²	2 x (0.5 ... 1.5)		
• AWG cables, solid or stranded	AWG	2 x (20 ... 14)		
Max. external diameter of the conductor insulation	mm	3.6		
Connection type	 Ring terminal lug connections			
Terminal screw	M3, Pozidriv size 2			
Operating devices	mm	∅ 5 ... 6		
Tightening torque	Nm	0.8 ... 1.2		
Usable ring terminal lugs	mm	d ₂ = min. 3.2, d ₃ = max. 7.5		
• DIN 46234 without insulation sleeve				
• DIN 46225 without insulation sleeve				
• DIN 46237 with insulation sleeve				
• JIS C2805 Type R without insulation sleeve				
• JIS C2805 Type RAV with insulation sleeve				
• JIS C2805 Type RAP with insulation sleeve				

¹⁾ If two different conductor cross-sections are connected to one clamping point, both cross-sections must be in the range specified.

Terminals for "Self-Protected Combination Motor Controllers (Type E) according to UL 508/UL 60947-4-1"

Type	3RV2928-1H
Prescribed tightening torque	Nm 2.5 ... 3
Conductor cross-sections	
• Front clamping point connected	
 - Solid	mm ² 1 ... 10
- Finely stranded with end sleeve	mm ² 1 ... 16
- Stranded	mm ² 2.5 ... 25
- AWG cables, solid or stranded	AWG 14 ... 3
- Terminal screw	M4
• Rear clamping point connected	
 - Solid	mm ² 1 ... 10
- Finely stranded with end sleeve	mm ² 1 ... 16
- Stranded	mm ² 1.5 ... 25
- AWG cables, solid or stranded	AWG 14 ... 6
- Terminal screw	M4
• Both clamping points connected	
 - Front clamping point:	
Solid	mm ² 1 ... 10
Finely stranded with end sleeve	mm ² 1 ... 10 ¹⁾ , 1 ... 6 ¹⁾
Stranded	mm ² 2.5 ... 10
AWG cables, solid or stranded	AWG 14 ... 6
Terminal screw	M4
- Rear clamping point:	
Solid	mm ² 1 ... 10
Finely stranded with end sleeve	mm ² 1 ... 10 ¹⁾ , 1 ... 16 ¹⁾
Stranded	mm ² 2.5 ... 10
AWG cables, solid or stranded	AWG 16 ... 3
Terminal screw	M4

¹⁾ The following can be connected when both clamping points are connected:

- Front 1 ... 10 mm² and rear 1 ... 10 mm²
- Front 1 ... 6 mm² and rear 1 ... 16 mm²

Motor Starter Protectors/Circuit Breakers

SIRIUS 3RV2 Motor Starter Protectors up to 80 A

For motor protection

Selection and ordering data

CLASS 10, without auxiliary switches¹⁾

PU (UNIT, SET, M) = 1
 PS* = 1 unit
 PG = 41E

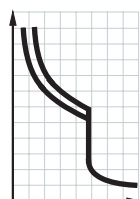

3RV2011-0AA10



3RV2011-0EA20



3RV2021-4AA10



3RV2021-4AA20

Rated current I_n A	Suitable for three-phase motors ²⁾ with P kW	Setting range for thermal overload release A	Instantaneous overcurrent release A	Short-circuit breaking capacity at 400 V AC kA	DT	Screw terminals		Spring-type terminals	
						Article No.	Price per PU	Article No.	Price per PU
Size S00									
0.16	0.04	0.11 ... 0.16	2.1	100		▶ 3RV2011-0AA10		▶ 3RV2011-0AA20	
0.2	0.06	0.14 ... 0.2	2.6	100		▶ 3RV2011-0BA10		▶ 3RV2011-0BA20	
0.25	0.06	0.18 ... 0.25	3.3	100		▶ 3RV2011-0CA10		▶ 3RV2011-0CA20	
0.32	0.09	0.22 ... 0.32	4.2	100		▶ 3RV2011-0DA10		▶ 3RV2011-0DA20	
0.4	0.09	0.28 ... 0.4	5.2	100		▶ 3RV2011-0EA10		▶ 3RV2011-0EA20	
0.5	0.12	0.35 ... 0.5	6.5	100		▶ 3RV2011-0FA10		▶ 3RV2011-0FA20	
0.63	0.18	0.45 ... 0.63	8.2	100		▶ 3RV2011-0GA10		▶ 3RV2011-0GA20	
0.8	0.18	0.55 ... 0.8	10	100		▶ 3RV2011-0HA10		▶ 3RV2011-0HA20	
1	0.25	0.7 ... 1	13	100		▶ 3RV2011-0JA10		▶ 3RV2011-0JA20	
1.25	0.37	0.9 ... 1.25	16	100		▶ 3RV2011-0KA10		▶ 3RV2011-0KA20	
1.6	0.55	1.1 ... 1.6	21	100		▶ 3RV2011-1AA10		▶ 3RV2011-1AA20	
2	0.75	1.4 ... 2	26	100		▶ 3RV2011-1BA10		▶ 3RV2011-1BA20	
2.5	0.75	1.8 ... 2.5	33	100		▶ 3RV2011-1CA10		▶ 3RV2011-1CA20	
3.2	1.1	2.2 ... 3.2	42	100		▶ 3RV2011-1DA10		▶ 3RV2011-1DA20	
4	1.5	2.8 ... 4	52	100		▶ 3RV2011-1EA10		▶ 3RV2011-1EA20	
5	1.5	3.5 ... 5	65	100		▶ 3RV2011-1FA10		▶ 3RV2011-1FA20	
6.3	2.2	4.5 ... 6.3	82	100		▶ 3RV2011-1GA10		▶ 3RV2011-1GA20	
8	3	5.5 ... 8	104	100		▶ 3RV2011-1HA10		▶ 3RV2011-1HA20	
10	4	7 ... 10	130	100		▶ 3RV2011-1JA10		▶ 3RV2011-1JA20	
12.5	5.5	9 ... 12.5	163	100		▶ 3RV2011-1KA10		▶ 3RV2011-1KA20	
16	7.5	10 ³⁾ ... 16	208	55		▶ 3RV2011-4AA10		▶ 3RV2011-4AA20	
Size S0									
0.63	0.18	0.45 ... 0.63	8.2	100	NEW B	▶ 3RV2021-0GA10	B	▶ 3RV2021-0GA20	
0.8	0.18	0.55 ... 0.8	10	100	NEW B	▶ 3RV2021-0HA10	B	▶ 3RV2021-0HA20	
1	0.25	0.7 ... 1	13	100	NEW B	▶ 3RV2021-0JA10	B	▶ 3RV2021-0JA20	
1.25	0.37	0.9 ... 1.25	16	100	NEW B	▶ 3RV2021-0KA10	B	▶ 3RV2021-0KA20	
1.6	0.55	1.1 ... 1.6	21	100	NEW B	▶ 3RV2021-1AA10	B	▶ 3RV2021-1AA20	
2	0.75	1.4 ... 2	26	100	NEW B	▶ 3RV2021-1BA10	B	▶ 3RV2021-1BA20	
2.5	0.75	1.8 ... 2.5	33	100	NEW B	▶ 3RV2021-1CA10	B	▶ 3RV2021-1CA20	
3.2	1.1	2.2 ... 3.2	42	100	NEW B	▶ 3RV2021-1DA10	B	▶ 3RV2021-1DA20	
4	1.5	2.8 ... 4	52	100	NEW B	▶ 3RV2021-1EA10	B	▶ 3RV2021-1EA20	
5	1.5	3.5 ... 5	65	100	NEW B	▶ 3RV2021-1FA10	B	▶ 3RV2021-1FA20	
6.3	2.2	4.5 ... 6.3	82	100	NEW B	▶ 3RV2021-1GA10	B	▶ 3RV2021-1GA20	
8	3	5.5 ... 8	104	100	NEW B	▶ 3RV2021-1HA10	B	▶ 3RV2021-1HA20	
10	4	7 ... 10	130	100	NEW B	▶ 3RV2021-1JA10	B	▶ 3RV2021-1JA20	
12.5	5.5	9 ... 12.5	163	100	NEW B	▶ 3RV2021-1KA10	B	▶ 3RV2021-1KA20	
16	7.5	10 ³⁾ ... 16	208	55		▶ 3RV2021-4AA10		▶ 3RV2021-4AA20	
20	7.5	13 ³⁾ ... 20	260	55		▶ 3RV2021-4BA10		▶ 3RV2021-4BA20	
22	11	16 ³⁾ ... 22	286	55		▶ 3RV2021-4CA10		▶ 3RV2021-4CA20	
25	11	18 ³⁾ ... 25	325	55		▶ 3RV2021-4DA10		▶ 3RV2021-4DA20	
28	15	23 ... 28	364	55		▶ 3RV2021-4NA10		▶ 3RV2021-4NA20	
32 ⁴⁾	15	27 ... 32	400	55		▶ 3RV2021-4EA10		▶ 3RV2021-4EA20	
36 ⁵⁾	18.5	30 ... 36	432	20		▶ 3RV2021-4PA10		--	
40 ⁵⁾	18.5	34 ... 40	480	20		▶ 3RV2021-4FA10		--	

1) The 3RV20.1-...A.0 motor starter protectors up to 32 A are also available with ring terminal lug connection. The Article No. must be changed in the 11th digit to "4": e.g. 3RV2011-0AA40.

2) Guide value for 4-pole standard motors at 50 Hz 400 V AC. The actual starting and rated data of the motor to be protected must be considered when selecting the units.

3) The setting range of the thermal overload releases has been extended.

4) Suitable for use with IE3 motors up to a starting current of 256 A. For higher starting currents we recommend using 3RV2 motor starter protectors size S2.

5) The devices must not be mounted side-by-side and they must not be assembled with link modules with contactors. A lateral clearance of 9 mm is required. For use with IE3 motors we recommend using 3RV2 motor starter protectors size S2.

Auxiliary switches and other accessories can be ordered separately (see "Accessories" page 7/32 onwards).

Motor Starter Protectors/Circuit Breakers

SIRIUS 3RV2 Motor Starter Protectors up to 80 A

For motor protection

CLASS 10, without auxiliary switches

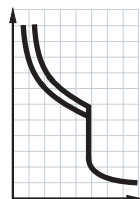

3RV2031-4.A10



3RV2032-4.A10

Rated current	Suitable for three-phase motors ¹⁾ with P	Setting range for thermal overload release	Instantaneous overcurrent release	Short-circuit breaking capacity at 400 V AC	DT	Screw terminals	⊕	PU (UNIT, SET, M)	PS*	PG
I_n			$I >$	I_{cu}		Article No.	Price per PU			
A	kW	A	A	kA						
Size S2										
14	5.5	9.5 ... 14	208	65	NEW A	3RV2031-4SA10		1	1 unit	41E
17	7.5	12 ... 17	260	65	NEW A	3RV2031-4TA10		1	1 unit	41E
20	7.5	14 ... 20	260	65	NEW A	3RV2031-4BA10		1	1 unit	41E
25	11	18 ... 25	325	65	NEW A	3RV2031-4DA10		1	1 unit	41E
32	15	22 ... 32	416	65	NEW A	3RV2031-4EA10		1	1 unit	41E
36	18.5	28 ... 36	520	65	NEW A	3RV2031-4PA10		1	1 unit	41E
40	18.5	32 ... 40	585	65	NEW A	3RV2031-4UA10		1	1 unit	41E
45	22	35 ... 45	650	65	NEW A	3RV2031-4VA10		1	1 unit	41E
52	22	42 ... 52	741	65	NEW A	3RV2031-4WA10		1	1 unit	41E
59 ²⁾	30	49 ... 59	845	65	NEW X	3RV2031-4XA10		1	1 unit	41E
65 ²⁾	30	54 ... 65	845	65	NEW X	3RV2031-4JA10		1	1 unit	41E
73 ²⁾	37	62 ... 73	949	65	NEW X	3RV2031-4KA10		1	1 unit	41E
80 ²⁾³⁾	37	70 ... 80	1 040	65	NEW X	3RV2031-4RA10		1	1 unit	41E
Size S2, with increased switching capacity										
14	5.5	9.5 ... 14	208	100	NEW A	3RV2032-4SA10		1	1 unit	41E
17	7.5	12 ... 17	260	100	NEW A	3RV2032-4TA10		1	1 unit	41E
20	7.5	14 ... 20	260	100	NEW A	3RV2032-4BA10		1	1 unit	41E
25	11	18 ... 25	325	100	NEW A	3RV2032-4DA10		1	1 unit	41E
32	15	22 ... 32	416	100	NEW A	3RV2032-4EA10		1	1 unit	41E
36	18.5	28 ... 36	520	100	NEW A	3RV2032-4PA10		1	1 unit	41E
40	18.5	32 ... 40	585	100	NEW A	3RV2032-4UA10		1	1 unit	41E
45	22	35 ... 45	650	100	NEW A	3RV2032-4VA10		1	1 unit	41E
52	22	42 ... 52	741	100	NEW A	3RV2032-4WA10		1	1 unit	41E
59 ²⁾	30	49 ... 59	845	100	NEW X	3RV2032-4XA10		1	1 unit	41E
65 ²⁾	30	54 ... 65	845	100	NEW X	3RV2032-4JA10		1	1 unit	41E
73 ²⁾	37	62 ... 73	949	100	NEW X	3RV2032-4KA10		1	1 unit	41E
80 ²⁾³⁾	37	70 ... 80	1 040	100	NEW X	3RV2032-4RA10		1	1 unit	41E

¹⁾ Guide value for 4-pole standard motors at 50 Hz 400 V AC. The actual starting and rated data of the motor to be protected must be considered when selecting the units.

²⁾ Start of delivery on request.

³⁾ Suitable for use with IE3 motors up to a starting current of 720 A. For higher starting currents we recommend using 3RV1 motor starter protectors size S3.

Auxiliary switches and other accessories can be ordered separately (see "Accessories" page 7/32 onwards).

Motor Starter Protectors/Circuit Breakers

SIRIUS 3RV2 Motor Starter Protectors up to 80 A

For motor protection

CLASS 10, with transverse auxiliary switch (1 NO + 1 NC)

PU (UNIT, SET, M) = 1
 PS* = 1 unit
 PG = 41E

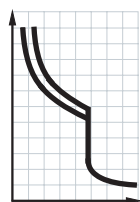

3RV2011-4AA15
with integrated transverse
auxiliary switch



3RV2011-0EA25
with integrated transverse
auxiliary switch



3RV2021-4AA15
with integrated transverse
auxiliary switch



3RV2021-4AA25
with integrated transverse
auxiliary switch

Rated current	Suitable for three-phase motors ¹⁾ with P	Setting range for thermal overload release	Instantaneous overcurrent release	Short-circuit breaking capacity at 400 V AC	DT	Screw terminals	DT	Spring-type terminals	
I_n	kW		$I >$	I_{cu}		Article No.	Price per PU	Article No.	Price per PU
A		A	A	kA					
Size S00									
0.16	0.04	0.11 ... 0.16	2.1	100	▶	3RV2011-0AA15	▶	3RV2011-0AA25	▶
0.2	0.06	0.14 ... 0.2	2.6	100	▶	3RV2011-0BA15	▶	3RV2011-0BA25	▶
0.25	0.06	0.18 ... 0.25	3.3	100	▶	3RV2011-0CA15	▶	3RV2011-0CA25	▶
0.32	0.09	0.22 ... 0.32	4.2	100	▶	3RV2011-0DA15	▶	3RV2011-0DA25	▶
0.4	0.09	0.28 ... 0.4	5.2	100	▶	3RV2011-0EA15	▶	3RV2011-0EA25	▶
0.5	0.12	0.35 ... 0.5	6.5	100	▶	3RV2011-0FA15	▶	3RV2011-0FA25	▶
0.63	0.18	0.45 ... 0.63	8.2	100	▶	3RV2011-0GA15	▶	3RV2011-0GA25	▶
0.8	0.18	0.55 ... 0.8	10	100	▶	3RV2011-0HA15	▶	3RV2011-0HA25	▶
1	0.25	0.7 ... 1	13	100	▶	3RV2011-0JA15	▶	3RV2011-0JA25	▶
1.25	0.37	0.9 ... 1.25	16	100	▶	3RV2011-0KA15	▶	3RV2011-0KA25	▶
1.6	0.55	1.1 ... 1.6	21	100	▶	3RV2011-1AA15	▶	3RV2011-1AA25	▶
2	0.75	1.4 ... 2	26	100	▶	3RV2011-1BA15	▶	3RV2011-1BA25	▶
2.5	0.75	1.8 ... 2.5	33	100	▶	3RV2011-1CA15	▶	3RV2011-1CA25	▶
3.2	1.1	2.2 ... 3.2	42	100	▶	3RV2011-1DA15	▶	3RV2011-1DA25	▶
4	1.5	2.8 ... 4	52	100	▶	3RV2011-1EA15	▶	3RV2011-1EA25	▶
5	1.5	3.5 ... 5	65	100	▶	3RV2011-1FA15	▶	3RV2011-1FA25	▶
6.3	2.2	4.5 ... 6.3	82	100	▶	3RV2011-1GA15	▶	3RV2011-1GA25	▶
8	3	5.5 ... 8	104	100	▶	3RV2011-1HA15	▶	3RV2011-1HA25	▶
10	4	7 ... 10	130	100	▶	3RV2011-1JA15	▶	3RV2011-1JA25	▶
12.5	5.5	9 ... 12.5	163	100	▶	3RV2011-1KA15	▶	3RV2011-1KA25	▶
16	7.5	10 ²⁾ ... 16	208	55	▶	3RV2011-4AA15	▶	3RV2011-4AA25	▶
Size S0									
16	7.5	10 ²⁾ ... 16	208	55	▶	3RV2021-4AA15	▶	3RV2021-4AA25	▶
20	7.5	13 ²⁾ ... 20	260	55	▶	3RV2021-4BA15	▶	3RV2021-4BA25	▶
22	11	16 ²⁾ ... 22	286	55	▶	3RV2021-4CA15	▶	3RV2021-4CA25	▶
25	11	18 ²⁾ ... 25	325	55	▶	3RV2021-4DA15	▶	3RV2021-4DA25	▶
28	15	23 ... 28	364	55	▶	3RV2021-4NA15	▶	3RV2021-4NA25	▶
32 ³⁾	15	27 ... 32	400	55	▶	3RV2021-4EA15	▶	3RV2021-4EA25	▶
36 ⁴⁾	18.5	30 ... 36	432	20	▶	3RV2021-4PA15	▶	--	--
40 ⁴⁾	18.5	34 ... 40	480	20	▶	3RV2021-4FA15	▶	--	--

1) Guide value for 4-pole standard motors at 50 Hz 400 V AC. The actual starting and rated data of the motor to be protected must be considered when selecting the units.

2) The setting range of the thermal overload releases has been extended.

3) Suitable for use with IE3 motors up to a starting current of 256 A. For higher starting currents we recommend using 3RV2 motor starter protectors size S2.

4) The devices must not be mounted side-by-side and they must not be assembled with link modules with contactors. A lateral clearance of 9 mm is required. For use with IE3 motors we recommend using 3RV2 motor starter protectors size S2.

Auxiliary switches and other accessories can be ordered separately (see "Accessories" page 7/32 onwards).

Motor Starter Protectors/Circuit Breakers

SIRIUS 3RV2 Motor Starter Protectors up to 80 A

For motor protection

CLASS 20, without auxiliary switches

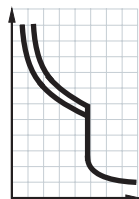

3RV2031-4-B10



3RV2031-4-WB10

Rated current	Suitable for three-phase motors ¹⁾ with P	Setting range for thermal overload release	Instantaneous overcurrent release	Short-circuit breaking capacity at 400 V AC	DT	Screw terminals	⊕	PU (UNIT, SET, M)	PS*	PG
I_n				I_{cu}		Article No.	Price per PU			
A	kW	A	A	kA						
Size S2										
14	5.5	9.5 ... 14	208	65	NEW A	3RV2031-4SB10		1	1 unit	41E
17	7.5	12 ... 17	260	65	NEW A	3RV2031-4TB10		1	1 unit	41E
20	7.5	14 ... 20	260	65	NEW A	3RV2031-4BB10		1	1 unit	41E
25	11	18 ... 25	325	65	NEW A	3RV2031-4DB10		1	1 unit	41E
32	15	22 ... 32	416	65	NEW A	3RV2031-4EB10		1	1 unit	41E
36	18.5	28 ... 36	520	65	NEW A	3RV2031-4PB10		1	1 unit	41E
40	18.5	32 ... 40	585	65	NEW A	3RV2031-4UB10		1	1 unit	41E
45	22	35 ... 45	650	65	NEW A	3RV2031-4VB10		1	1 unit	41E
52	22	42 ... 52	741	65	NEW A	3RV2031-4WB10		1	1 unit	41E
59 ²⁾	30	49 ... 59	845	65	NEW X	3RV2031-4XB10		1	1 unit	41E
65 ²⁾	30	54 ... 65	845	65	NEW X	3RV2031-4JB10		1	1 unit	41E

¹⁾ Guide value for 4-pole standard motors at 50 Hz 400 V AC. The actual starting and rated data of the motor to be protected must be considered when selecting the units.

²⁾ Start of delivery on request.

Auxiliary switches and other accessories can be ordered separately (see "Accessories" page 7/32 onwards).

Motor Starter Protectors/Circuit Breakers SIRIUS 3RV2 Motor Starter Protectors up to 80 A

For motor protection with overload relay function

Selection and ordering data

CLASS 10, with overload relay function (automatic RESET), without auxiliary switches

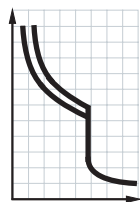

3RV2111-0FA10



3RV2121-4BA10



3RV2131-4.B10



3RV2131-4WB10

Rated current	Suitable for three-phase motors ¹⁾ with P	Setting range for thermal overload release	Instantaneous overcurrent release	Short-circuit breaking capacity at 400 V AC	DT	Screw terminals	PU (UNIT, SET, M)	PS*	PG
I_n				I_{cu}		Article No.	Price per PU		
A	kW	A	A	kA					
Size S0²⁾									
0.16	0.04	0.11 ... 0.16	2.1	100	A	3RV2111-0AA10	1	1 unit	41E
0.2	0.06	0.14 ... 0.2	2.6	100	A	3RV2111-0BA10	1	1 unit	41E
0.25	0.06	0.18 ... 0.25	3.3	100	A	3RV2111-0CA10	1	1 unit	41E
0.32	0.09	0.22 ... 0.32	4.2	100	A	3RV2111-0DA10	1	1 unit	41E
0.4	0.09	0.28 ... 0.4	5.2	100	A	3RV2111-0EA10	1	1 unit	41E
0.5	0.12	0.35 ... 0.5	6.5	100	A	3RV2111-0FA10	1	1 unit	41E
0.63	0.18	0.45 ... 0.63	8.2	100	A	3RV2111-0GA10	1	1 unit	41E
0.8	0.18	0.55 ... 0.8	10	100	A	3RV2111-0HA10	1	1 unit	41E
1	0.25	0.7 ... 1	13	100	A	3RV2111-0JA10	1	1 unit	41E
1.25	0.37	0.9 ... 1.25	16	100	A	3RV2111-0KA10	1	1 unit	41E
1.6	0.55	1.1 ... 1.6	21	100	A	3RV2111-1AA10	1	1 unit	41E
2	0.75	1.4 ... 2	26	100	A	3RV2111-1BA10	1	1 unit	41E
2.5	0.75	1.8 ... 2.5	33	100	A	3RV2111-1CA10	1	1 unit	41E
3.2	1.1	2.2 ... 3.2	42	100	A	3RV2111-1DA10	1	1 unit	41E
4	1.5	2.8 ... 4	52	100	A	3RV2111-1EA10	1	1 unit	41E
5	1.5	3.5 ... 5	65	100	A	3RV2111-1FA10	1	1 unit	41E
6.3	2.2	4.5 ... 6.3	82	100	A	3RV2111-1GA10	1	1 unit	41E
8	3	5.5 ... 8	104	100	A	3RV2111-1HA10	1	1 unit	41E
10	4	7 ... 10	130	100	A	3RV2111-1JA10	1	1 unit	41E
12.5	5.5	9 ... 12.5	163	100	A	3RV2111-1KA10	1	1 unit	41E
16	7.5	10 ³⁾ ... 16	208	55	A	3RV2111-4AA10	1	1 unit	41E
Size S0²⁾									
16	7.5	10 ³⁾ ... 16	208	55	A	3RV2121-4AA10	1	1 unit	41E
20	7.5	13 ³⁾ ... 20	260	55	A	3RV2121-4BA10	1	1 unit	41E
22	11	16 ³⁾ ... 22	286	55	A	3RV2121-4CA10	1	1 unit	41E
25	11	18 ³⁾ ... 25	325	55	A	3RV2121-4DA10	1	1 unit	41E
28	15	23 ... 28	364	55	A	3RV2121-4NA10	1	1 unit	41E
32 ⁴⁾	15	27 ... 32	400	55	A	3RV2121-4EA10	1	1 unit	41E
Size S2²⁾									
14	5.5	9.5 ... 14	208	65	NEW A	3RV2131-4SA10	1	1 unit	41E
17	7.5	12 ... 17	260	65	NEW A	3RV2131-4TA10	1	1 unit	41E
20	7.5	14 ... 20	260	65	NEW A	3RV2131-4BA10	1	1 unit	41E
25	11	18 ... 25	325	65	NEW A	3RV2131-4DA10	1	1 unit	41E
32	15	22 ... 32	416	65	NEW A	3RV2131-4EA10	1	1 unit	41E
36	18.5	28 ... 36	520	65	NEW A	3RV2131-4PA10	1	1 unit	41E
40	18.5	32 ... 40	585	65	NEW A	3RV2131-4UA10	1	1 unit	41E
45	22	35 ... 45	650	65	NEW A	3RV2131-4VA10	1	1 unit	41E
52	22	42 ... 52	741	65	NEW A	3RV2131-4WA10	1	1 unit	41E
59 ⁵⁾	30	49 ... 59	845	65	NEW X	3RV2131-4XA10	1	1 unit	41E
65 ⁵⁾	30	54 ... 65	845	65	NEW X	3RV2131-4JA10	1	1 unit	41E
73 ⁵⁾	37	62 ... 73	949	65	NEW X	3RV2131-4KA10	1	1 unit	41E
80 ⁵⁾⁶⁾	37	70 ... 80	1 040	65	NEW X	3RV2131-4RA10	1	1 unit	41E

¹⁾ Guide value for 4-pole standard motors at 50 Hz 400 V AC. The actual starting and rated data of the motor to be protected must be considered when selecting the units.

²⁾ Accessories for mounting on the right and 3RV2915 three-phase busbars cannot be used.

³⁾ The setting range of the thermal overload releases has been extended.

⁴⁾ Suitable for use with IE3 motors up to a starting current of 256 A. For higher starting currents we recommend using 3RV2 motor starter protectors size S2.

⁵⁾ Start of delivery on request.

⁶⁾ Suitable for use with IE3 motors up to a starting current of 720 A. For higher starting currents we recommend using 3RV1 motor starter protectors size S3.

Auxiliary switches and other accessories can be ordered separately (see "Accessories" page 7/32 onwards).

Motor Starter Protectors/Circuit Breakers

SIRIUS 3RV2 Motor Starter Protectors up to 80 A

For starter combinations

Selection and ordering data

Without auxiliary switches

PU (UNIT, SET, M) = 1
 PS* = 1 unit
 PG = 41E

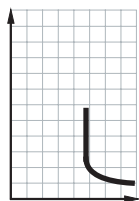

3RV2311-4AC10



3RV2311-0JC20



3RV2321-4AC10



3RV2321-4AC20

Rated current	Suitable for three-phase motors ¹⁾ with P	Thermal overload release ²⁾	Instantaneous overcurrent release	Short-circuit breaking capacity at 400 V AC	DT	Screw terminals	DT	Spring-type terminals	
I_n				I_{cu}					
A	kW	A	A	kA		Article No.	Price per PU	Article No.	Price per PU
Size S00									
0.16	0.04	Without	2.1	100	B	3RV2311-0AC10	B	3RV2311-0AC20	
0.2	0.06	Without	2.6	100	B	3RV2311-0BC10	B	3RV2311-0BC20	
0.25	0.06	Without	3.3	100	B	3RV2311-0CC10	B	3RV2311-0CC20	
0.32	0.09	Without	4.2	100	B	3RV2311-0DC10	B	3RV2311-0DC20	
0.4	0.09	Without	5.2	100	B	3RV2311-0EC10	B	3RV2311-0EC20	
0.5	0.12	Without	6.5	100	B	3RV2311-0FC10	B	3RV2311-0FC20	
0.63	0.18	Without	8.2	100	B	3RV2311-0GC10	B	3RV2311-0GC20	
0.8	0.18	Without	10	100	B	3RV2311-0HC10	B	3RV2311-0HC20	
1	0.25	Without	13	100	B	3RV2311-0JC10	B	3RV2311-0JC20	
1.25	0.37	Without	16	100	B	3RV2311-0KC10	B	3RV2311-0KC20	
1.6	0.55	Without	21	100	B	3RV2311-1AC10	B	3RV2311-1AC20	
2	0.75	Without	26	100	B	3RV2311-1BC10	B	3RV2311-1BC20	
2.5	0.75	Without	33	100	B	3RV2311-1CC10	B	3RV2311-1CC20	
3.2	1.1	Without	42	100	B	3RV2311-1DC10	B	3RV2311-1DC20	
4	1.5	Without	52	100	B	3RV2311-1EC10	B	3RV2311-1EC20	
5	1.5	Without	65	100	B	3RV2311-1FC10	B	3RV2311-1FC20	
6.3	2.2	Without	82	100	B	3RV2311-1GC10	B	3RV2311-1GC20	
8	3	Without	104	100	B	3RV2311-1HC10	B	3RV2311-1HC20	
10	4	Without	130	100	B	3RV2311-1JC10	B	3RV2311-1JC20	
12.5	5.5	Without	163	100	B	3RV2311-1KC10	B	3RV2311-1KC20	
16	7.5	Without	208	55	B	3RV2311-4AC10	B	3RV2311-4AC20	
Size S0									
1.6	0.55	Without	21	100	NEW B	3RV2321-1AC10	B	3RV2321-1AC20	
2	0.75	Without	26	100	NEW B	3RV2321-1BC10	B	3RV2321-1BC20	
2.5	0.75	Without	33	100	NEW B	3RV2321-1CC10	B	3RV2321-1CC20	
3.2	1.1	Without	42	100	NEW B	3RV2321-1DC10	B	3RV2321-1DC20	
4	1.5	Without	52	100	NEW B	3RV2321-1EC10	B	3RV2321-1EC20	
5	1.5	Without	65	100	NEW B	3RV2321-1FC10	B	3RV2321-1FC20	
6.3	2.2	Without	82	100	NEW B	3RV2321-1GC10	B	3RV2321-1GC20	
8	3	Without	104	100	NEW B	3RV2321-1HC10	B	3RV2321-1HC20	
10	4	Without	130	100	NEW B	3RV2321-1JC10	B	3RV2321-1JC20	
12.5	5.5	Without	163	100	NEW B	3RV2321-1KC10	B	3RV2321-1KC20	
16	7.5	Without	208	55	B	3RV2321-4AC10	B	3RV2321-4AC20	
20	7.5	Without	260	55	B	3RV2321-4BC10	B	3RV2321-4BC20	
22	11	Without	286	55	B	3RV2321-4CC10	B	3RV2321-4CC20	
25	11	Without	325	55	B	3RV2321-4DC10	B	3RV2321-4DC20	
28	15	Without	364	55	B	3RV2321-4NC10	B	3RV2321-4NC20	
32 ³⁾	15	Without	400	55	B	3RV2321-4EC10	B	3RV2321-4EC20	
36 ⁴⁾	18.5	Without	432	20	B	3RV2321-4PC10		--	
40 ⁴⁾	18.5	Without	480	20	B	3RV2321-4FC10		--	

¹⁾ Guide value for 4-pole standard motors at 50 Hz 400 V AC. The actual starting and rated data of the motor to be protected must be considered when selecting the units.

²⁾ For overload protection of the motors, appropriate overload relays must be used.

³⁾ Suitable for use with IE3 motors up to a starting current of 256 A. For higher starting currents we recommend using 3RV2 motor starter protectors size S2.

⁴⁾ The devices must not be mounted side-by-side and they must not be assembled with link modules with contactors. A lateral clearance of 9 mm is required. For use with IE3 motors we recommend using 3RV2 motor starter protectors size S2.

Size S2, see page 7/27.

Auxiliary switches and other accessories can be ordered separately (see "Accessories" page 7/32 onwards).

Motor Starter Protectors/Circuit Breakers

SIRIUS 3RV2 Motor Starter Protectors up to 80 A

For starter combinations

Without auxiliary switches (continued)

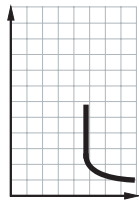

Rated current	Suitable for three-phase motors ¹⁾ with P	Thermal overload release ²⁾	Instantaneous overcurrent release	Short-circuit breaking capacity at 400 V AC	DT	Screw terminals	PU (UNIT, SET, M)	PS*	PG
I_n				I_{cu}		Article No.	Price per PU		
A	kW	A	A	kA					
Size S2									
14	5.5	Without	208	65	NEW A	3RV2331-4SC10		1	1 unit 41E
17	7.5	Without	260	65	NEW A	3RV2331-4TC10		1	1 unit 41E
20	7.5	Without	260	65	NEW A	3RV2331-4BC10		1	1 unit 41E
25	11	Without	325	65	NEW A	3RV2331-4DC10		1	1 unit 41E
32	15	Without	416	65	NEW A	3RV2331-4EC10		1	1 unit 41E
36	18.5	Without	520	65	NEW A	3RV2331-4PC10		1	1 unit 41E
40	18.5	Without	585	65	NEW A	3RV2331-4UC10		1	1 unit 41E
45	22	Without	650	65	NEW A	3RV2331-4VC10		1	1 unit 41E
52	22	Without	741	65	NEW A	3RV2331-4WC10		1	1 unit 41E
59 ³⁾	30	Without	845	65	NEW X	3RV2331-4XC10		1	1 unit 41E
65 ³⁾	30	Without	845	65	NEW X	3RV2331-4JC10		1	1 unit 41E
73 ³⁾	37	Without	949	65	NEW X	3RV2331-4KC10		1	1 unit 41E
80 ³⁾⁴⁾	37	Without	1 040	65	NEW X	3RV2331-4RC10		1	1 unit 41E
Size S2, with increased switching capacity									
14	5.5	Without	208	100	NEW A	3RV2332-4SC10		1	1 unit 41E
17	7.5	Without	260	100	NEW A	3RV2332-4TC10		1	1 unit 41E
20	7.5	Without	260	100	NEW A	3RV2332-4BC10		1	1 unit 41E
25	11	Without	325	100	NEW A	3RV2332-4DC10		1	1 unit 41E
32	15	Without	416	100	NEW A	3RV2332-4EC10		1	1 unit 41E
36	18.5	Without	520	100	NEW A	3RV2332-4PC10		1	1 unit 41E
40	18.5	Without	585	100	NEW A	3RV2332-4UC10		1	1 unit 41E
45	22	Without	650	100	NEW A	3RV2332-4VC10		1	1 unit 41E
52	22	Without	741	100	NEW A	3RV2332-4WC10		1	1 unit 41E
59 ³⁾	30	Without	845	100	NEW X	3RV2332-4XC10		1	1 unit 41E
65 ³⁾	30	Without	845	100	NEW X	3RV2332-4JC10		1	1 unit 41E
73 ³⁾	37	Without	949	100	NEW X	3RV2332-4KC10		1	1 unit 41E
80 ³⁾⁴⁾	37	Without	1 040	100	NEW X	3RV2332-4RC10		1	1 unit 41E

- ¹⁾ Guide value for 4-pole standard motors at 50 Hz 400 V AC. The actual starting and rated data of the motor to be protected must be considered when selecting the units.
- ²⁾ For overload protection of the motors, appropriate overload relays must be used.
- ³⁾ Start of delivery on request.
- ⁴⁾ Suitable for use with IE3 motors up to a starting current of 720 A. For higher starting currents we recommend using 3RV1 motor starter protectors size S3.

Auxiliary switches and other accessories can be ordered separately (see "Accessories" page 7/32 onwards).

Motor Starter Protectors/Circuit Breakers

SIRIUS 3RV2 Motor Starter Protectors up to 80 A

For transformer protection

Selection and ordering data

CLASS 10, without auxiliary switches

Motor starter protectors for the protection of transformers with high inrush current

PU (UNIT, SET, M) = 1
 PS* = 1 unit
 PG = 41E

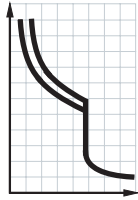

Rated current	Setting range for thermal overload release	Instantaneous overcurrent release	Short-circuit breaking capacity at 400 V AC	DT	Screw terminals	DT	Spring-type terminals
I_n	I_{set}	$I >$	I_{cu}		Article No.	Price per PU	Article No.
A	A	A	kA				Price per PU
Size S00							
0.16	0.11 ... 0.16	3.3	100	▶	3RV2411-0AA10	A	3RV2411-0AA20
0.2	0.14 ... 0.2	4.2	100	▶	3RV2411-0BA10	A	3RV2411-0BA20
0.25	0.18 ... 0.25	5.2	100	▶	3RV2411-0CA10	A	3RV2411-0CA20
0.32	0.22 ... 0.32	6.5	100	▶	3RV2411-0DA10	A	3RV2411-0DA20
0.4	0.28 ... 0.4	8.2	100	▶	3RV2411-0EA10	A	3RV2411-0EA20
0.5	0.35 ... 0.5	10	100	▶	3RV2411-0FA10	A	3RV2411-0FA20
0.63	0.45 ... 0.63	13	100	▶	3RV2411-0GA10	A	3RV2411-0GA20
0.8	0.55 ... 0.8	16	100	▶	3RV2411-0HA10	A	3RV2411-0HA20
1	0.7 ... 1	21	100	▶	3RV2411-0JA10	A	3RV2411-0JA20
1.25	0.9 ... 1.25	26	100	▶	3RV2411-0KA10	A	3RV2411-0KA20
1.6	1.1 ... 1.6	33	100	▶	3RV2411-1AA10	A	3RV2411-1AA20
2	1.4 ... 2	42	100	▶	3RV2411-1BA10	A	3RV2411-1BA20
2.5	1.8 ... 2.5	52	100	▶	3RV2411-1CA10	A	3RV2411-1CA20
3.2	2.2 ... 3.2	65	100	▶	3RV2411-1DA10	A	3RV2411-1DA20
4	2.8 ... 4	82	100	▶	3RV2411-1EA10	A	3RV2411-1EA20
5	3.5 ... 5	104	100	▶	3RV2411-1FA10	A	3RV2411-1FA20
6.3	4.5 ... 6.3	130	100	▶	3RV2411-1GA10	A	3RV2411-1GA20
8	5.5 ... 8	163	100	▶	3RV2411-1HA10	A	3RV2411-1HA20
10	7 ... 10	208	100	▶	3RV2411-1JA10	A	3RV2411-1JA20
12.5	9 ... 12.5	260	100	▶	3RV2411-1KA10	A	3RV2411-1KA20
16	10 ¹⁾ ... 16	286	55	▶	3RV2411-4AA10	A	3RV2411-4AA20
Size S0							
16	10 ¹⁾ ... 16	286	55	▶	3RV2421-4AA10	A	3RV2421-4AA20
20	13 ¹⁾ ... 20	325	55	▶	3RV2421-4BA10	A	3RV2421-4BA20
22	16 ¹⁾ ... 22	364	55	▶	3RV2421-4CA10	A	3RV2421-4CA20
25	18 ¹⁾ ... 25	400	55	▶	3RV2421-4DA10	A	3RV2421-4DA20
Size S2							
14	9.5 ... 14	328	65	NEW A	3RV2431-4SA10	--	--
17	12 ... 17	410	65	NEW A	3RV2431-4TA10	--	--
20	14 ... 20	410	65	NEW A	3RV2431-4BA10	--	--
25	18 ... 25	512	65	NEW A	3RV2431-4DA10	--	--
32	22 ... 32	656	65	NEW A	3RV2431-4EA10	--	--
36	28 ... 36	820	65	NEW A	3RV2431-4PA10	--	--
40	32 ... 40	820	65	NEW A	3RV2431-4UA10	--	--
45	35 ... 45	922	65	NEW A	3RV2431-4VA10	--	--
52	42 ... 52	1 025	65	NEW A	3RV2431-4WA10	--	--
59 ²⁾	49 ... 59	1 332	65	NEW X	3RV2431-4XA10	--	--
65 ²⁾	54 ... 65	1 332	65	NEW X	3RV2431-4JA10	--	--

¹⁾ The setting range of the thermal overload releases has been extended.

²⁾ Start of delivery on request.

Auxiliary switches and other accessories can be ordered separately (see "Accessories" page 7/32 onwards).

Motor Starter Protectors/Circuit Breakers

SIRIUS 3RV2 Circuit Breakers up to 80 A

For system protection according to UL 489/CSA C22.2 No. 5

Selection and ordering data

Without auxiliary switches

Circuit breakers for system protection and non-motor loads according to UL/CSA

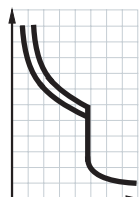

3RV2711-0AD10

Rated current ¹⁾	Thermal overload releases (non-adjustable)	Instantaneous overcurrent release	Short-circuit breaking capacity at 480 Y/277 V AC ²⁾	DT	Screw terminals	⊕	PU (UNIT, SET, M)	PS*	PG
I_n ¹⁾		$I >$	I_{bc}		Article No.	Price per PU			
A	A	A	kA						
Size S00									
0.16	0.16	2.1	65	B	3RV2711-0AD10		1	1 unit	41E
0.2	0.2	2.6	65	B	3RV2711-0BD10		1	1 unit	41E
0.25	0.25	3.3	65	B	3RV2711-0CD10		1	1 unit	41E
0.32	0.32	4.2	65	B	3RV2711-0DD10		1	1 unit	41E
0.4	0.4	5.2	65	B	3RV2711-0ED10		1	1 unit	41E
0.5	0.5	6.5	65	B	3RV2711-0FD10		1	1 unit	41E
0.63	0.63	8.2	65	B	3RV2711-0GD10		1	1 unit	41E
0.8	0.8	10	65	B	3RV2711-0HD10		1	1 unit	41E
1	1	13	65	B	3RV2711-0JD10		1	1 unit	41E
1.25	1.25	16	65	B	3RV2711-0KD10		1	1 unit	41E
1.6	1.6	21	65	B	3RV2711-1AD10		1	1 unit	41E
2	2	26	65	B	3RV2711-1BD10		1	1 unit	41E
2.5	2.5	33	65	B	3RV2711-1CD10		1	1 unit	41E
3.2	3.2	42	65	B	3RV2711-1DD10		1	1 unit	41E
4	4	52	65	B	3RV2711-1ED10		1	1 unit	41E
5	5	65	65	B	3RV2711-1FD10		1	1 unit	41E
6.3	6.3	82	65	B	3RV2711-1GD10		1	1 unit	41E
8	8	104	65	B	3RV2711-1HD10		1	1 unit	41E
10	10	130	65	B	3RV2711-1JD10		1	1 unit	41E
12.5	12.5	163	65	B	3RV2711-1KD10		1	1 unit	41E
15	15	208	65	B	3RV2711-4AD10		1	1 unit	41E
Size S0									
20	20	260	50	NEW B	3RV2721-4BD10		1	1 unit	41E
22	22	286	50	NEW B	3RV2721-4CD10		1	1 unit	41E

¹⁾ Rated value 100 % according to UL 489 and IEC 60947-2 ("100 % rated breaker").

²⁾ Values for 600 Y/347 V AC, see page 7/15.

Lateral and transverse auxiliary switches can be ordered separately (see "Accessories" from page 7/32 onwards).

Motor Starter Protectors/Circuit Breakers

SIRIUS 3RV2 Circuit Breakers up to 80 A

For transformer protection according to UL 489/CSA C22.2 No.5

Selection and ordering data

Without auxiliary switches

Circuit breakers for system and transformer protection according to UL/CSA, specially designed for transformers with high inrush current

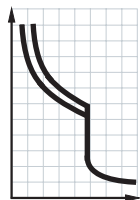

3RV2811-0AD10

Rated current ¹⁾	Thermal overload releases (non-adjustable)	Instantaneous overcurrent release	Short-circuit breaking capacity at 480 Y/277 V AC ²⁾	DT	Screw terminals	⊕	PU (UNIT, SET, M)	PS*	PG
$I_n^{1)}$		$I >$	I_{bc}		Article No.	Price per PU			
A	A	A	kA						
Size S00									
0.16	0.16	3.3	65	B	3RV2811-0AD10		1	1 unit	41E
0.2	0.2	4.2	65	B	3RV2811-0BD10		1	1 unit	41E
0.25	0.25	5.2	65	B	3RV2811-0CD10		1	1 unit	41E
0.32	0.32	6.5	65	B	3RV2811-0DD10		1	1 unit	41E
0.4	0.4	8.2	65	B	3RV2811-0ED10		1	1 unit	41E
0.5	0.5	10	65	B	3RV2811-0FD10		1	1 unit	41E
0.63	0.63	13	65	B	3RV2811-0GD10		1	1 unit	41E
0.8	0.8	16	65	B	3RV2811-0HD10		1	1 unit	41E
1	1	21	65	B	3RV2811-0JD10		1	1 unit	41E
1.25	1.25	26	65	B	3RV2811-0KD10		1	1 unit	41E
1.6	1.6	33	65	B	3RV2811-1AD10		1	1 unit	41E
2	2	42	65	B	3RV2811-1BD10		1	1 unit	41E
2.5	2.5	52	65	B	3RV2811-1CD10		1	1 unit	41E
3.2	3.2	65	65	B	3RV2811-1DD10		1	1 unit	41E
4	4	82	65	B	3RV2811-1ED10		1	1 unit	41E
5	5	104	65	B	3RV2811-1FD10		1	1 unit	41E
6.3	6.3	130	65	B	3RV2811-1GD10		1	1 unit	41E
8	8	163	65	B	3RV2811-1HD10		1	1 unit	41E
10	10	208	65	B	3RV2811-1JD10		1	1 unit	41E
12.5	12.5	260	65	B	3RV2811-1KD10		1	1 unit	41E
15	15	286	65	B	3RV2811-4AD10		1	1 unit	41E
Size S0									
20	20	325	50	NEW B	3RV2821-4BD10		1	1 unit	41E
22	22	364	50	NEW B	3RV2821-4CD10		1	1 unit	41E

1) Rated value 100 % according to UL 489 and IEC 60947-2 ("100 % rated breaker").

2) Values for 600 Y/347 V AC, see page 7/15.

Lateral and transverse auxiliary switches can be ordered separately (see "Accessories" from page 7/32 onwards).

Motor Starter Protectors/Circuit Breakers

SIRIUS 3RV2 Motor Starter Protectors/Circuit Breakers up to 80 A

Accessories

Mountable accessories

Overview

Mounting location and function

The 3RV2 motor starter protectors/circuit breakers have three main contact elements. In order to achieve maximum flexibility, auxiliary switches, signaling switches, auxiliary releases and isolator modules can be supplied separately.

These components are easily fitted to the switches without the use of any tools according to requirements.

Overview graphic, [see page 7/7](#).

<p>Front side</p> <p><u>Note:</u></p> <ul style="list-style-type: none"> A maximum of four auxiliary contacts with auxiliary switches can be mounted on each motor starter protector/circuit breaker. 	<p>Transverse auxiliary switches, solid-state compatible transverse auxiliary switches</p> <p>1 NO + 1 NC or 2 NO or 1 CO</p>	<p>An auxiliary switch block can be inserted transversely on the front. The overall width of the motor starter protectors/circuit breakers remains unchanged.</p>
<p>Left-hand side</p> <p><u>Notes:</u></p> <ul style="list-style-type: none"> A maximum of four auxiliary contacts with auxiliary switches can be mounted on each motor starter protector/circuit breaker. Lateral auxiliary switches (two contacts) and signaling switches can be mounted separately or together. The signaling switch cannot be used for the 3RV27 and 3RV28 circuit breakers. 	<p>Lateral auxiliary switches (2 contacts)</p> <p>1 NO + 1 NC or 2 NO or 2 NC</p> <p>Lateral auxiliary switches (4 contacts)</p> <p>2 NO + 2 NC</p>	<p>One of the three lateral auxiliary switches can be mounted on the left side per motor starter protector/circuit breaker. The contacts of the auxiliary switch close and open together with the main contacts of the motor starter protector/circuit breaker.</p> <p>The width of the lateral auxiliary switch with two contacts is 9 mm.</p> <p>One lateral auxiliary switch with four contacts can be mounted on the left side per motor starter protector/circuit breaker. The contacts of the auxiliary switch close and open together with the main contacts of the motor starter protector/circuit breaker.</p> <p>The width of the lateral auxiliary switch with four contacts is 18 mm.</p>
<p>Right-hand side</p> <p><u>Notes:</u></p> <ul style="list-style-type: none"> One auxiliary release can be mounted per motor starter protector/circuit breaker. Accessories cannot be mounted at the right-hand side of the 3RV21 motor starter protectors for motor protection with overload relay function. 	<p>Signaling switches</p> <p>Tripping 1 NO + 1 NC Short circuit 1 NO + 1 NC</p>	<p>One signaling switch can be mounted on the left side of each motor starter protector.</p> <p>The signaling switch has two contact systems.</p> <p>One contact system always signals tripping irrespective of whether this was caused by a short circuit, an overload or an auxiliary release. The other contact system only switches in the event of a short circuit. There is no signaling as a result of switching off with the actuator.</p> <p>In order to be able to switch on the motor starter protector again after a short circuit, the signaling switch must be reset manually after the error cause has been eliminated.</p> <p>The overall width of the signaling switch is 18 mm.</p>
<p>Top</p> <p><u>Notes:</u></p> <ul style="list-style-type: none"> The isolator module cannot be used for the 3RV27 and 3RV28 circuit breakers. The isolator module for size S2 <ul style="list-style-type: none"> can only be used with 3RV2 motor starter protectors/circuit breakers up to max. 65 A cannot be used with the transverse auxiliary switch The isolator module covers the terminal screws of the transverse auxiliary switch. If the isolator module is used, we therefore recommend that either the lateral auxiliary switches be fitted or that the isolator module not be mounted until the auxiliary switch has been wired. 	<p>Auxiliary releases</p> <p>Shunt releases</p> <p>or</p> <p>Undervoltage releases</p> <p>or</p> <p>Undervoltage releases with leading auxiliary contacts 2 NO</p>	<p>For remote-controlled tripping of the motor starter protector/circuit breaker. The release coil should only be energized for short periods (see circuit diagrams).</p> <p>Trips the motor starter protector/circuit breaker when the voltage is interrupted and prevents the motor from being restarted accidentally when the voltage is restored. Used for remote-controlled tripping of the motor starter protector/circuit breaker.</p> <p>Particularly suitable for EMERGENCY-STOP disconnection by way of corresponding EMERGENCY-STOP pushbuttons according to DIN EN 60204-1.</p> <p>Function and use as for the undervoltage release without leading auxiliary contacts, but with the following additional function: the auxiliary contacts will open in switch position OFF to deenergize the coil of the undervoltage release, thus interrupting energy consumption. In the "tripped" position, these auxiliary contacts are not guaranteed to open. The leading contacts permit the motor starter protector/circuit breaker to reclose.</p> <p>The overall width of the auxiliary release is 18 mm.</p>
<p>Isolator modules</p> <p><u>Notes:</u></p> <ul style="list-style-type: none"> The isolator module cannot be used for the 3RV27 and 3RV28 circuit breakers. The isolator module for size S2 <ul style="list-style-type: none"> can only be used with 3RV2 motor starter protectors/circuit breakers up to max. 65 A cannot be used with the transverse auxiliary switch The isolator module covers the terminal screws of the transverse auxiliary switch. If the isolator module is used, we therefore recommend that either the lateral auxiliary switches be fitted or that the isolator module not be mounted until the auxiliary switch has been wired. 	<p>Isolator modules</p>	<p>Isolator modules can be mounted to the upper connection side of the motor starter protectors.</p> <p>The supply cable is connected to the motor starter protector through the isolator module.</p> <p>The plug can only be unplugged when the motor starter protector is open and isolates all 3 poles of the motor starter protector from the network. The shock-protected isolation point is clearly visible and secured with a padlock to prevent reinsertion of the plug.</p>

For a complete overview of which accessories can be used for the various motor starter protectors/circuit breakers, [see page 7/2](#).

Motor Starter Protectors/Circuit Breakers

SIRIUS 3RV2 Motor Starter Protectors/Circuit Breakers up to 80 A

Accessories

Mountable accessories

PU (UNIT, SET, M) = 1
 PS* = 1 unit
 PG = 41E



3RV2902-1AV0





3RV2902-2AV0



3RV2922-1CP0



3RV2902-2DB0

Rated control supply voltage U_s						For motor starter protectors/circuit breakers	DT	Screw terminals 		DT	Spring-type terminals 	
AC 50 Hz	AC 60 Hz	AC 50/60 Hz	AC/DC 50/60 Hz, DC	DC	Article No.			Price per PU	Article No.		Price per PU	
V	V	V	V	V	Size							
Auxiliary releases³⁾												
Undervoltage releases												
--	--	--	--	--	24	S00 ... S2	A	3RV2902-1AB4	--			
24	--	--	--	--	--	S00 ... S2	A	3RV2902-1AB0	--			
110	120	--	--	--	--	S00 ... S2	A	3RV2902-1AF0	--			
--	208	--	--	--	--	S00 ... S2	A	3RV2902-1AM1	--			
230	240	--	--	--	--	S00 ... S2	4) ▶	3RV2902-1AP0	▶	3RV2902-2AP0		
400	440	--	--	--	--	S00 ... S2	4) ▶	3RV2902-1AV0	▶	3RV2902-2AV0		
415	480	--	--	--	--	S00 ... S2	A	3RV2902-1AV1	--			
500	600	--	--	--	--	S00 ... S2	A	3RV2902-1AS0	--			
Undervoltage releases with leading auxiliary contacts 2 NO												
24	24	--	--	--	--	S00 ... S2	B	3RV2922-1CB0	--			
230	240	--	--	--	--	S00 ... S2	A	3RV2922-1CP0	A	3RV2922-2CP0		
400	440	--	--	--	--	S00 ... S2	A	3RV2922-1CV0	A	3RV2922-2CV0		
415	480	--	--	--	--	S00 ... S2	4) A	3RV2922-1CV1	A	3RV2922-2CV1		
Shunt releases												
--	--	20 ... 24	20 ... 70	--	--	S00 ... S2	▶	3RV2902-1DB0	▶	3RV2902-2DB0		
--	--	90 ... 110	70 ... 190	--	--	S00 ... S2	4) A	3RV2902-1DF0	A	3RV2902-2DF0		
--	--	210 ... 240	190 ... 330	--	--	S00 ... S2	4) ▶	3RV2902-1DP0	▶	3RV2902-2DP0		
--	--	350 ... 415	330 ... 500	--	--	S00 ... S2	A	3RV2902-1DV0	--			
--	--	500	500	--	--	S00 ... S2	A	3RV2902-1DS0	--			

1) The voltage range is valid for 100 % (infinite) ON period. The response voltage lies at 0.9 of the lower limit of the voltage range.

2) The voltage range is valid for 5 s ON period at AC 50/60Hz and DC. The response voltage lies at 0.85 of the lower limit of the voltage range.

3) One auxiliary release can be mounted on the right per motor starter protector/circuit breaker (does not apply to 3RV21 motor starter protectors with overload relay function).

4) The 3RV29 auxiliary releases are also available with ring terminal lug connection. The Article No. must be changed in the 8th digit to "4": e.g. 3RV2902-4AP0.

Motor Starter Protectors/Circuit Breakers

SIRIUS 3RV2 Motor Starter Protectors/Circuit Breakers up to 80 A Accessories

Busbar accessories

Overview

Insulated three-phase busbar system

Three-phase busbar systems provide an easy, time-saving and clearly arranged means of feeding 3RV2 motor starter protector/circuit breakers with screw terminals. Different versions are available for sizes S00 to S2 and can be used for the various different types of motor starter protectors/circuit breakers (size S0 up to 32 A).

The 3RV1915 and 3RV1935 three-phase busbar systems are generally unsuitable for the 3RV21 motor starter protectors for motor protection with overload relay function and 3RV27 and 3RV28 circuit breakers according to UL 489/CSA C22.2 No. 5.

The busbars are suitable for between two and five motor starter protectors/circuit breakers. However, any kind of extension is possible by clamping the tags of an additional busbar (rotated by 180°) underneath the terminals of the respective last motor starter protector/circuit breaker.

A combination of motor starter protectors/circuit breakers of size S00 and S0 is possible. The motor starter protectors/circuit breakers are supplied by appropriate infeed terminals.

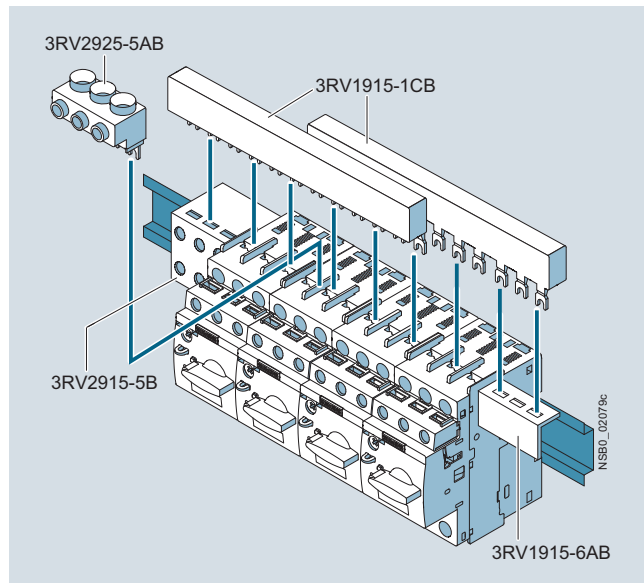

SIRIUS three-phase busbar system size S00/S0

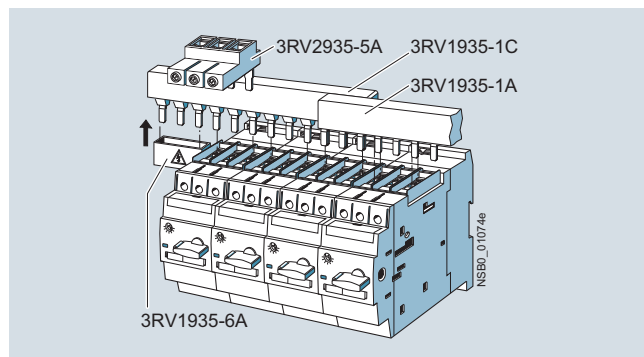

SIRIUS three-phase busbar system size S2

The three-phase busbar systems are finger-safe. They are designed for any short-circuit stress which can occur at the output side of connected motor starter protectors/circuit breakers.

The three-phase busbar systems can also be used to construct "Type E Starters" according to UL/CSA. Special infeed terminals must be used for this purpose, however (see "Selection and Ordering Data", page 7/35).

8US busbar adapters for 60 mm systems

The motor starter protectors/circuit breakers are mounted directly with the aid of busbar adapters on busbar systems with 60 mm center-to-center clearance in order to save space and to reduce infeed times and costs.

The busbar adapters for busbar systems with 60 mm center-to-center clearance are suitable for copper busbars with a width of 12 mm to 30 mm. The busbars can be 5 mm or 10 mm thick.

The motor starter protectors/circuit breakers are snapped onto the adapter and connected on the line side. This prepared unit is then plugged directly onto the busbar system, and is thus connected both mechanically and electrically at the same time.

For further busbar adapters for snap-mounting direct-on-line starters and reversing starters as well as additional accessories such as line terminals and outgoing terminals, flat copper profile, etc., see [Catalog LV 10 "Low-Voltage Power Distribution and Electrical Installation Technology"](#).

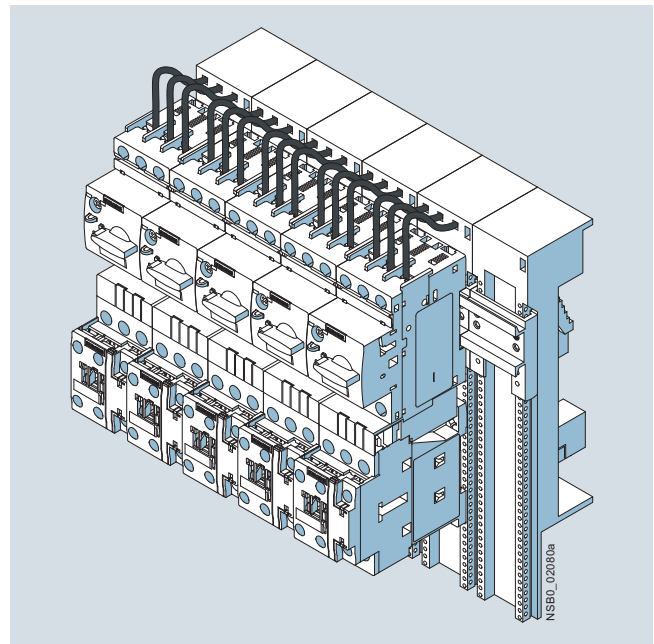

SIRIUS load feeders with busbar adapters snapped onto busbars





Motor Starter Protectors/Circuit Breakers

SIRIUS 3RV2 Motor Starter Protectors/Circuit Breakers up to 80 A

Accessories

Busbar accessories

Selection and ordering data

	Modular spacing mm	Number of motor starter protectors that can be connected			Rated current I_n at 690 V A	For motor starter protectors Size	DT	Article No.	Price per PU	PU (UNIT, SET, M)	PS*	PG
		Without lateral accessories	With lateral auxiliary switch	With auxiliary release								
Three-phase busbars¹⁾												
 3RV1915-1AB	45 ³⁾	2	--	--	63	S00, S0 ²⁾	▶	3RV1915-1AB		1	1 unit	41E
		3	--	--	63	S00, S0 ²⁾	▶	3RV1915-1BB		1	1 unit	41E
		4	--	--	63	S00, S0 ²⁾	▶	3RV1915-1CB		1	1 unit	41E
		5	--	--	63	S00, S0 ²⁾	▶	3RV1915-1DB		1	1 unit	41E
		3RV1915-1BB	55 ⁴⁾	--	2	--	63	S00, S0 ²⁾	▶	3RV1915-2AB		1
 3RV1915-1BB	55 ⁴⁾	--	3	--	63	S00, S0 ²⁾	▶	3RV1915-2BB		1	1 unit	41E
		--	4	--	63	S00, S0 ²⁾	▶	3RV1915-2CB		1	1 unit	41E
		--	5	--	63	S00, S0 ²⁾	▶	3RV1915-2DB		1	1 unit	41E
 3RV1915-1CB	63 ⁵⁾	2	--	--	108	S2	▶	3RV1935-1A		1	1 unit	41E
		3	--	--	108	S2	▶	3RV1935-1B		1	1 unit	41E
		4	--	--	108	S2	▶	3RV1935-1C		1	1 unit	41E
 3RV1915-1DB	75 ⁵⁾	--	--	2	63	S00, S0 ²⁾	▶	3RV1915-3AB		1	1 unit	41E
		--	--	4	63	S00, S0 ²⁾	▶	3RV1915-3CB		1	1 unit	41E
		--	2	2	108	S2	▶	3RV1935-3A		1	1 unit	41E
		--	3	3	108	S2	▶	3RV1935-3B		1	1 unit	41E
		--	4	4	108	S2	▶	3RV1935-3C		1	1 unit	41E



1) Not suitable for 3RV21 motor starter protectors for motor protection with overload relay function and for 3RV27 and 3RV28 circuit breakers according to UL 489/CSA C22.2 No. 5.

2) Approved for motor starter protectors size S0 with $I_n \leq 32$ A.



3) For 3RV2 motor starter protectors without accessories mounted on the side.

4) For 3RV2 motor starter protectors with auxiliary switches with 1 NO + 1 NC, 2 NO and 2 NC mounted on the left (9 mm wide).

5) For 3RV2 motor starter protectors with mounted accessories (18 mm wide). Auxiliary switches with 2 NO + 2 NC or signaling switch (mounted on the left) or with auxiliary release (mounted on the right).

	Conductor cross-section			Tightening torque Nm	For motor starter protectors/circuit breakers Size	DT	Article No.	Price per PU	PU (UNIT, SET, M)	PS*	PG
	Solid or stranded mm ²	Finely stranded with end sleeve mm ²	AWG cables, solid or stranded AWG								
Three-phase infeed terminals											
 3RV2925-5AB	Connection from top										
	2.5 ... 25	2.5 ... 16	10 ... 4	3 ... 4	S00, S0	▶	3RV2925-5AB		1	1 unit	41E
	2 x (2.5 ... 50) ¹⁾ , 1 x (2.5 ... 70) ¹⁾	2 x (2.5 ... 35) ¹⁾ , 1 x (2.5 ... 50) ¹⁾	2 x (10 ... 1/0) ¹⁾ , 1 x (10 ... 2/0) ¹⁾	4 ... 6	S2 NEW A		3RV2935-5A		1	1 unit	41E
 3RV2935-5A	Connection from below										
	This terminal is connected in place of a switch, please take the space requirement into account.										
 3RV2915-5B	2.5 ... 25	2.5 ... 16	10 ... 4	Input: 4, Output: 2 ... 2.5	S00, S0	▶	3RV2915-5B		1	1 unit	41E

Three-phase infeed terminals for constructing "Type E Starters"

 3RV2925-5EB	Connection from top										
	2.5 ... 25	2.5 ... 16	10 ... 4	3 ... 4	S00, S0	A	3RV2925-5EB		1	1 unit	41E
	2 x (2.5 ... 50) ¹⁾ , 1 x (2.5 ... 70) ¹⁾	2 x (2.5 ... 35) ¹⁾ , 1 x (2.5 ... 50) ¹⁾	2 x (10 ... 1/0) ¹⁾ , 1 x (10 ... 2/0) ¹⁾	4 ... 6	S2 NEW A		3RV2935-5E		1	1 unit	41E
 3RV2935-5E	Connection from below										
	This terminal is connected in place of a switch, please take the space requirement into account.										

1) If two different conductor cross-sections are connected to one clamping point, both cross-sections must be in the range specified.

Motor Starter Protectors/Circuit Breakers

SIRIUS 3RV2 Motor Starter Protectors/Circuit Breakers up to 80 A Accessories

Busbar accessories

Version	For motor starter protectors/ circuit breakers	DT	Article No.	Price per PU	PU (UNIT, SET, M)	PS*	PG
---------	---	----	-------------	-----------------	-------------------------	-----	----

Covers for connection tags



3RV1915-6AB

Touch protection for empty positions

S00, S0



3RV1915-6AB

1 10 units

41E

S2



3RV1935-6A

1 5 units

41E

Busbar adapters



8US1251-5DS10



8US1251-5DT11



8US1250-5AS10



8US1250-5AT10

For motor starter protectors/ circuit breakers	Rated current	Connecting cable	Adapter length	Adapter width	Rated voltage	DT	Article No.	Price per PU	PU (UNIT, SET, M)	PS*	PG
---	---------------	---------------------	-------------------	------------------	---------------	----	-------------	-----------------	-------------------------	-----	----

Size

A

AWG

mm

mm

V

Size

A

AWG

mm

mm

V

Size

A

AWG

mm

mm

V

Size

A

AWG

mm

mm

V

Size

A

AWG

mm

mm

V

Size

A

AWG

mm

mm

V

Size

A

AWG

mm

mm

V

Size

A

AWG

mm

mm

V

Size

A

AWG

mm

mm

V

Size

A

AWG

mm

mm

V

Size

A

AWG

mm

mm

V

Size

A

AWG

mm

mm

V

Size

A

AWG

mm

mm

V

Size

A

AWG

mm

mm

V

Size

A

AWG

mm

mm

V

Size

A

AWG

mm

mm

V

Size

A

AWG

mm

mm

V

Size

A

AWG

mm

mm

V

Size

A

AWG

mm

mm

V

Size

A

AWG

mm

mm

V

Size

A

AWG

mm

mm

V

Size

A

AWG

mm

mm

V

Size

A

AWG

mm

mm

V

Size

A

AWG

mm

mm

V

Size

A

AWG

mm

mm

V

Size

A

AWG

mm

mm

V

Size

A

AWG

mm

mm

V

Size

A

AWG

mm

mm

V

Size

A

AWG

mm

mm

V

Size

A

AWG

mm

mm

V

Size

A

AWG

mm

mm

V

Size

A

AWG

mm

mm

V

Size

A

AWG

mm

mm

V

Size

A

AWG

mm

mm

V

Size

A

AWG

mm

mm

V

Size

A

AWG

mm

mm

V

Size

A

AWG

mm

mm

V

Size

A

AWG

mm

mm

V

Size

A

AWG

mm

mm

V

Size

A

AWG

mm

mm

V

Size

A

AWG

mm

mm

V

Size

A

AWG

mm

mm

V

Size

A

AWG

mm

mm

V

Size

A

AWG

mm

mm

V

Size

A

AWG

mm

mm

V

Size

A

AWG

mm

mm

V

Size

A

AWG

mm

mm

V

Size

A

AWG

mm

mm

V

Size

A

AWG

mm

mm

V

Size

A

AWG

mm

mm

V

Size

A

AWG

mm

mm

V

Size

A

AWG

mm

mm

V

Size

A

AWG

mm

mm

V

Size

A

AWG

mm

mm

V

Size

A

AWG

mm

mm

V

Size

A

AWG

mm

mm

V

Size

A

AWG

mm

mm

V

Size

A

AWG

mm

mm

V

Size

A

AWG

mm

Motor Starter Protectors/Circuit Breakers

SIRIUS 3RV2 Motor Starter Protectors/Circuit Breakers up to 80 A

Accessories

Rotary operating mechanisms

Overview

Door-coupling rotary operating mechanisms

Motor starter protectors/circuit breakers with a rotary operating mechanism can be mounted in a control cabinet and operated externally by means of a door-coupling rotary operating mechanism. When the cabinet door with motor starter protector/circuit breaker is closed, the operating mechanism is coupled. When the motor starter protector/circuit breaker closes, the coupling is locked which prevents the door from being opened unintentionally. This interlock can be defeated by the maintenance personnel. In the OPEN position, the rotary operating mechanism can be secured against reclosing with up to three padlocks. Inadvertent opening of the door is not possible in this case either.

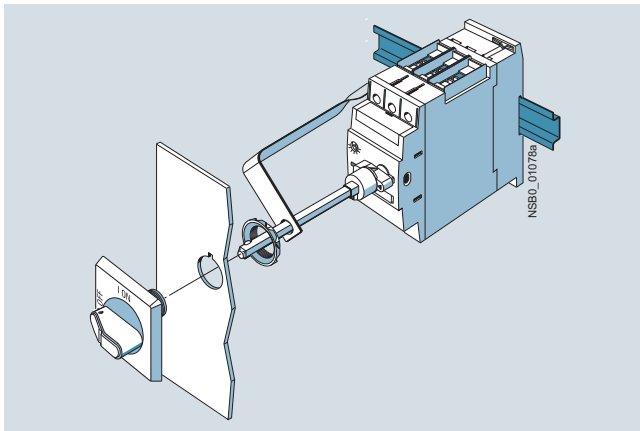

SIRIUS 3RV2926-0K door-coupling rotary operating mechanism

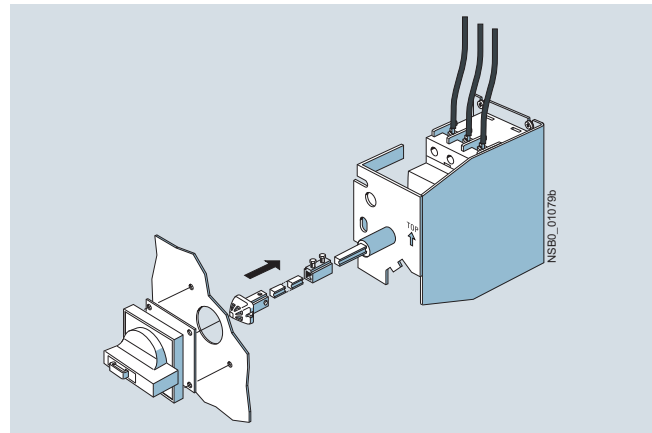

SIRIUS 3RV2926-2B door-coupling rotary operating mechanisms for arduous conditions

Selection and ordering data

Version	Color of handle	Version of extension shaft	For motor starter protectors/circuit breakers	DT	Article No.	Price per PU	PU (UNIT, SET, M)	PS*	PG
		mm	Size						

Door-coupling rotary operating mechanisms



3RV2926-0B

The door-coupling rotary operating mechanisms consist of a knob, a coupling driver and a 130/330 mm long extension shaft (6 mm x 6 mm). The door-coupling rotary operating mechanisms are designed to degree of protection IP64. The door locking device prevents accidental opening of the control cabinet door in the ON position of the motor starter protector/circuit breaker. The OFF position can be locked with up to three padlocks.

Door-coupling rotary operating mechanisms	Black	130 330	S00 ... S2 S00 ... S2	▶ ▶	3RV2926-0B 3RV2926-0K		1 1	1 unit 1 unit	41E 41E
EMERGENCY-STOP door-coupling rotary operating mechanisms	Red/yellow	130 330	S00 ... S2 S00 ... S2	▶ ▶	3RV2926-0C 3RV2926-0L		1 1	1 unit 1 unit	41E 41E

Door-coupling rotary operating mechanisms for arduous conditions



3RV2926-2B

The door-coupling rotary operating mechanisms consist of a knob, a coupling driver, an extension shaft of 300 mm in length (8 mm x 8 mm), a spacer and two metal brackets, into which the motor starter protector/circuit breaker is inserted.

The door-coupling rotary operating mechanisms are designed to degree of protection IP65. The door interlocking reliably prevents opening of the control cabinet door in the ON position of the motor starter protector/circuit breaker. The OFF position can be locked with up to three padlocks.

Laterally mountable auxiliary releases and two-pole auxiliary switches can be used.

The door-coupling rotary operating mechanisms thus meet the requirements for isolating functions according to IEC 60947-2.

Door-coupling rotary operating mechanisms	Gray	300	S00, S0 S2	▶ ▶	3RV2926-2B 3RV2936-2B		1 1	1 unit 1 unit	41E 41E
EMERGENCY STOP door-coupling rotary operating mechanisms	Red/yellow	300	S00, S0 S2	▶ ▶	3RV2926-2C 3RV2936-2C		1 1	1 unit 1 unit	41E 41E



3RV2936-2C

Motor Starter Protectors/Circuit Breakers

SIRIUS 3RV2 Motor Starter Protectors/Circuit Breakers up to 80 A Accessories

Mounting accessories

Overview

Accessories for "Self-Protected Combination Motor Controllers (Type E)" according to UL 508/UL 60947-4-1

The 3RV20 motor starter protectors with screw terminals are approved according to UL 508/UL 60947-4-1 as "Self-Protected Combination Motor Controllers (Type E)".

This requires increased clearance and creepage distances (1 inch and 2 inches respectively) at the input side of the device, which are achieved by mounting a terminal block or a phase barrier.

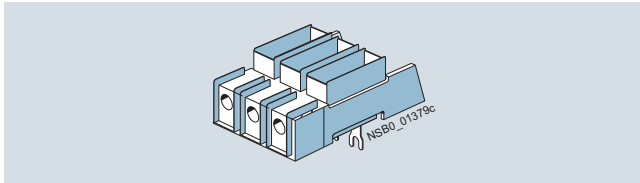

SIRIUS 3RV2928-1H terminal block

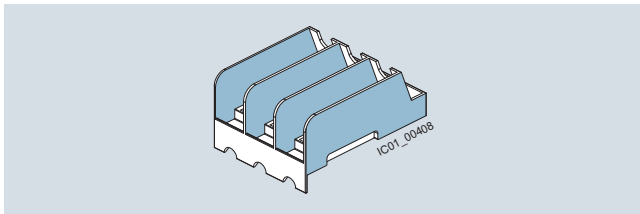

SIRIUS 3RV2938-1K phase barrier

Motor starter protectors/circuit breakers	Size	Essential accessories for "Self-Protected Combination Motor Controllers (Type E)" according to UL 508/UL 60947-4-1
3RV201., 3RV202.	S00/S0	3RV2928-1H terminal block or 3RV2928-1K phase barrier
3RV2031-4B1., 3RV2031-4D.1., 3RV2031-4E1., 3RV2031-4P.1., 3RV2031-4S.1., 3RV2031-4T.1., 3RV2031-4U.1., 3RV2031-4V.1.	S2	--
3RV2031-4J.1., 3RV2031-4K.1., 3RV2031-4R.1., 3RV2031-4W.1., 3RV2031-4X.1., 3RV2032	S2	3RV2938-1K phase barrier

-- No accessories needed

Special three-phase infeed terminals are required for constructing "Type E Starters" with an insulated three-phase busbar system (see "Busbar Accessories", page 7/35).

The 3RV29 infeed system also enables the assembly of "Type E Starters", see page 7/46 onwards.

Note:

According to CSA, these terminal blocks and the phase barriers can be omitted when the device is used as a "Self-Protected Combination Motor Controller (Type E)".

Link modules

Feeders can be easily assembled from single devices with the help of the link modules. The following table shows the different combination options for devices with screw or spring-type terminals.

Combination devices	3RV2 motor starter protectors/circuit breakers Size	3RT2 contactors; 3RW30, 3RW40 soft starters; 3RF34 solid-state contactors Size	Link modules Screw terminals	Spring-type terminals
Link modules for connecting switching devices to 3RV2 motor starter protectors/circuit breakers¹⁾				
3RT2 contactors with AC or DC coil	S00	S00	3RA1921-1DA00	3RA2911-2AA00
	S0	S00		--
	S2	S2	3RA2931-1AA00	--
3RT2 contactors with AC coil	S0	S0	3RA2921-1AA00	3RA2921-2AA00
	S00	S0		--
3RT2 contactors with DC coil	S0	S0	3RA2921-1BA00	3RA2921-2AA00
	S00	S0		--
3RW30 soft starters	S00	S00	3RA2921-1BA00	3RA2911-2GA00
	S0	S00		--
3RW30/3RW40 soft starters	S0	S0	3RA2921-1BA00	3RA2921-2GA00
	S00	S0		--
	S2 ²⁾	S2 ²⁾	3RA2931-1AA00	--
3RF34 solid-state contactors	S00/S0	S00	3RA2921-1BA00	--
Hybrid link modules for connecting contactors with spring-type terminals to 3RV2 motor starter protectors/circuit breakers with screw terminals³⁾				
3RT2 contactors with AC or DC coil	S00	S00	3RA2911-2FA00	--
	S0	S0	3RA2921-2FA00	--

-- Version not possible

¹⁾ The link modules cannot be used for the 3RV2.21-4PA1., 3RV2.21-4FA1., 3RV2.31-4K.1., 3RV2.31-4R.1., 3RV2.32-4K.1., 3RV2.32-4R.1., 3RV27 and 3RV28 motor starter protectors/circuit breakers.

²⁾ To assemble the feeder between a motor starter protector and a soft starter in size S2, the 3RA2932-1AC00 standard mounting rail adapter must be used.

³⁾ The motor starter protector to contactor hybrid link modules cannot be used for the 3RV2.21-4PA1., 3RV2.21-4FA1., 3RV27 and 3RV28 motor starter protectors/circuit breakers. They are only suitable for constructing direct-on-line starters.

Note:

- Link modules can be used in
 - Sizes S00 and S0: up to max. 32 A
 - Size S2: up to max. 65 A
- Hybrid link modules can be used in
 - Sizes S00 and S0: up to max. 32 A

Motor Starter Protectors/Circuit Breakers

SIRIUS 3RV2 Motor Starter Protectors/Circuit Breakers up to 80 A

Accessories

Mounting accessories

Selection and ordering data

Accessories

Version	For motor starter protectors/ circuit breakers Size	DT	Article No.	Price per PU	PU (UNIT, SET, M)	PS*	PG
Covers							
 3RV2908-0P	Scale covers Sealable, for covering the set current scale	3RV20, 3RV21, 3RV24: S00 ... S2	▶	3RV2908-0P		100 10 units	41E
 3RT2936-4EA2	Covers for devices with screw terminals (box terminals) Additional touch protection for fastening to the box terminals (2 units required per device) • Main current level	S2	NEW B	3RT2936-4EA2		1 1 unit	41B
 3RV2928-4AA00  3RV2908-4AA10	Covers for devices with ring terminal lug connection (ensure finger-safety) • Main current level • For transverse auxiliary switches	3RV20: S00, S0	B B	3RV2928-4AA00 3RV2908-4AA10		1 1 unit 1 1 unit	41E 41E
Fixing accessories							
 3RV2928-0B	Push-in lugs For screwing the motor starter protector/ circuit breakers onto mounting plates For each motor starter protector/circuit breakers, two units are required.	S00, S0	A	3RV2928-0B		100 10 units	41E
Tools for opening spring-type terminals							
 3RA2908-1A	Screwdrivers For all SIRIUS devices with spring-type terminals Length approx. 200 mm, 3.0 mm x 0.5 mm, titanium gray/black, partially insulated	S00 ... S2	A	3RA2908-1A		1 1 unit	41B
Terminal blocks and phase barriers for "Self-Protected Combination Motor Controllers (Type E)" according to UL 508/UL 60947-4-1							
 3RV2928-1H	Note: UL 508/UL 60947-4-1 approval demands 1-inch clearance and 2-inch creepage distance for "Self-Protected Combination Motor Controllers (Type E)". The following terminal blocks or phase barriers must be used for the 3RV20 motor starter protectors with screw terminals. The construction of 3RV20 motor starter protectors with spring-type terminals with the 3RV29 infeed system is also approved as "Self-Protected Combination Motor Controllers (Type E)" according to UL 508/UL 60947-4-1. The terminal block or phase barriers cannot be used in combination with the 3RV19.5 three-phase busbars. For construction with three-phase busbars, see "Busbar Accessories" page 7/34 onwards.						
 3RV2928-1K	Terminal blocks type E For extended clearance and creepage distances (1 and 2 inch)	S00, S0	▶	3RV2928-1H		1 1 unit	41E
 3RV2938-1K	Phase barriers For extended clearance and creepage distances (1 and 2 inch)	S00, S0 S2	▶ NEW A	3RV2928-1K 3RV2938-1K		1 1 unit 1 1 unit	41E 41E

Motor Starter Protectors/Circuit Breakers

SIRIUS 3RV2 Motor Starter Protectors/Circuit Breakers up to 80 A Accessories

Mounting accessories

Link modules

Actuating voltage of contactor	Size	DT	Article No.	Price per PU	PU (UNIT, SET, M)	PS*	PG
	3RT2 contactors	3RV2 motor starter protectors/circuit breakers					

Link modules for motor starter protector to contactor¹⁾

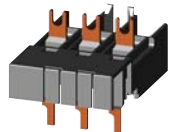

3RA2921-1AA00

For mechanical and electrical connection between motor starter protector and contactor with screw terminals

Single-unit packaging

AC/DC	S00	S00/S0	▶	3RA1921-1DA00	1	1 unit	41B
AC	S0	S00/S0	▶	3RA2921-1AA00	1	1 unit	41B
DC	S0	S00/S0	▶	3RA2921-1BA00	1	1 unit	41B
AC/DC	S2	S2	▶ NEW	3RA2931-1AA00	1	1 unit	41B

Multi-unit packaging

AC/DC	S00	S00/S0	▶	3RA1921-1D	1	10 units	41B
AC	S0	S00/S0	▶	3RA2921-1A	1	10 units	41B
DC	S0	S00/S0	▶	3RA2921-1B	1	10 units	41B
AC/DC	S2	S2	▶ NEW	3RA2931-1A	1	5 units	41B



3RA2931-1AA00

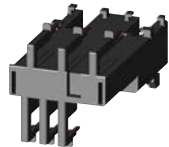

3RA2911-2AA00

For mechanical and electrical connection between motor starter protector and contactor with spring-type terminals

Single-unit packaging

AC/DC	S00	S00	▶	3RA2911-2AA00	1	1 unit	41B
AC ²⁾	S0	S0	▶	3RA2921-2AA00	1	1 unit	41B
DC	S0	S0	▶	3RA2921-2AA00	1	1 unit	41B

Multi-unit packaging

AC/DC	S00	S00	▶	3RA2911-2A	1	10 units	41B
AC ²⁾	S0	S0	▶	3RA2921-2A	1	10 units	41B
DC	S0	S0	▶	3RA2921-2A	1	10 units	41B

Spacers²⁾

For compensating the height on AC contactors

Single-unit packaging	S0	S0	▶	3RA2911-1CA00	1	1 unit	41B
Multi-unit packaging	S0	S0	▶	3RA2911-1C	1	5 units	41B



3RA2911-1CA00

Note:

Link modules can be used in

- Sizes S00 and S0 up to max. 32 A
- Size S2 up to max. 65 A

Screw terminals



Spring-type terminals



¹⁾ The link modules from motor starter protector to contactor cannot be used for the 3RV2.21-4PA1., 3RV2.21-4FA1., 3RV2.31-4K.1., 3RV2.31-4R.1., 3RV2.32-4K.1., 3RV2.32-4R.1., 3RV27 and 3RV28 motor starter protectors/circuit breakers.

²⁾ A spacer for height compensation on AC contactors size S0 is optionally available.

Motor Starter Protectors/Circuit Breakers



SIRIUS 3RV2 Motor Starter Protectors/Circuit Breakers up to 80 A

Accessories

Mounting accessories

Size		DT	Article No.	Price per PU	PU (UNIT, SET, M)	PS*	PG
3RW30, 3RW40 soft starters; 3RF34 solid-state contactors	3RV2 motor starter protectors/circuit breakers						

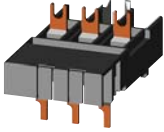
Link modules for motor starter protector to soft starter¹⁾ and motor starter protector to solid-state contactor

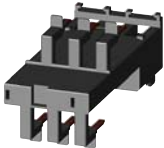
Connection between motor starter protector and soft starter / solid-state contactor with screw terminals		Screw terminals					
 3RA2921-1BA00	Single-unit packaging S00 S0 S2 ²⁾	S00/S0	A	3RA2921-1BA00	1	1 unit	41B
		S00/S0	A	3RA2921-1BA00	1	1 unit	41B
		S2	NEW A	3RA2931-1AA00	1	1 unit	41B
 3RA2931-1AA00	Multi-unit packaging S00 S0 S2 ²⁾	S00/S0	A	3RA2921-1B	1	10 units	41B
		S00/S0	A	3RA2921-1B	1	10 units	41B
		S2	NEW A	3RA2931-1A	1	5 units	41B
Connection between motor starter protector and soft starter spring-type terminals		Spring-type terminals					
 3RA2921-2GA00	Single-unit packaging S00 S0	S00	▶	3RA2911-2GA00	1	1 unit	41B
		S0	▶	3RA2921-2GA00	1	1 unit	41B
		Multi-unit packaging S00 S0	S00	▶	3RA2911-2G	1	10 units
S0	▶		3RA2921-2G	1	10 units	41B	

Note:

Link modules can be used in

- Sizes S00 and S0 up to max. 32 A
- Size S2 up to max. 65 A



¹⁾ The link modules from motor starter protector to soft starter and from motor starter protector to solid-state contactor cannot be used for the 3RV2.21-4PA1., 3RV2.21-4FA1., 3RV2.31-4K.1., 3RV2.31-4R.1., 3RV2.32-4K.1., 3RV2.32-4R.1., 3RV27 and 3RV28 motor starter protectors/circuit breakers.

²⁾ To assemble the feeder between a motor starter protector and a soft starter in size S2, the 3RA2932-1AC00 standard mounting rail adapter must be used.

Motor Starter Protectors/Circuit Breakers

SIRIUS 3RV2 Motor Starter Protectors/Circuit Breakers up to 80 A Accessories

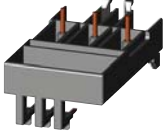
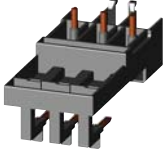
Mounting accessories

Actuating voltage of contactor	Size	DT	Article No.	Price per PU	PU (UNIT, SET, M)	PS*	PG
	3RT2 contactors	3RV2 motor starter protectors					
Hybrid link modules for motor starter protector to contactor¹⁾							
Mechanical and electrical connection between motor starter protector with screw terminals and contactor with spring-type terminals							
Single-unit packaging							
 3RA2911-2FA00	AC/DC	S00	S00	▶	3RA2911-2FA00	1	1 unit 41B
	AC ²⁾ /DC	S0	S0	▶	3RA2921-2FA00	1	1 unit 41B
Multi-unit packaging							
 3RA2921-2FA00	AC/DC	S00	S00	▶	3RA2911-2F	1	10 units 41B
	AC ²⁾ /DC	S0	S0	▶	3RA2921-2F	1	10 units 41B
Spacers²⁾							
For compensating the height on AC contactors							
 3RA2911-1CA00	Single-unit packaging	S0	S0	A	3RA2911-1CA00	1	1 unit 41B
	Multi-unit packaging	S0	S0	A	3RA2911-1C	1	5 units 41B

Note:

Hybrid link modules in sizes S00 and S0 up to max. 32 A can be used.

¹⁾ The hybrid link modules for motor starter protector to contactor cannot be used for the 3RV2.21-4PA1., 3RV2.21-4FA1., 3RV27 and 3RV28 motor starter protectors/circuit breakers. They are only suitable for constructing direct-on-line starters.

²⁾ A spacer for height compensation on AC contactors size S0 is optionally available.

More information

Manuals

- System Manual "SIRIUS Innovations – System Overview"
<http://support.automation.siemens.com/WW/view/en/60311318>

- Manual "SIRIUS Innovations – SIRIUS 3RV2 Motor Starter Protectors"
<http://support.automation.siemens.com/WW/view/en/60279172>

Motor Starter Protectors/Circuit Breakers

SIRIUS 3RV2 Motor Starter Protectors/Circuit Breakers up to 80 A

Accessories

Enclosures and front plates

Overview

Enclosures

For stand-alone installation of 3RV20 to 3RV24 motor starter protectors size S00 ($I_{n \max} = 16 \text{ A}$), S0 ($I_{n \max} = 32 \text{ A}$) and S2 ($I_{n \max} = 65 \text{ A}$), cast aluminum enclosures for surface mounting and molded-plastic enclosures for flush mounting are available in various dimensions.

When installed in a molded-plastic enclosure the motor starter protectors have a rated operational voltage U_e of 500 V.

The enclosures for surface mounting have the degree of protection IP55; the enclosures for flush mounting also comply with the degree of protection IP55 at the front (the flush-mounted section complies with IP20).

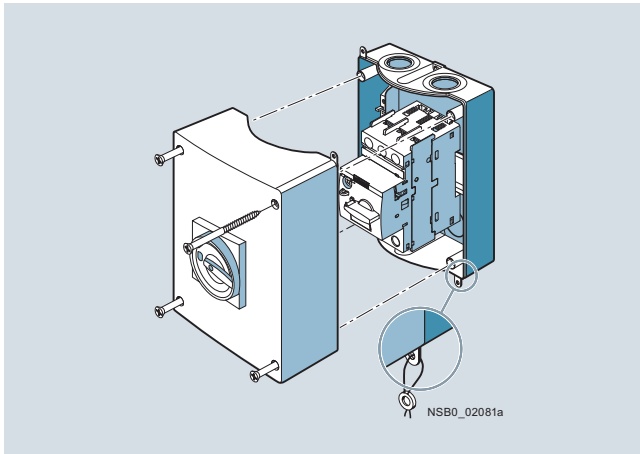

Enclosures for surface mounting

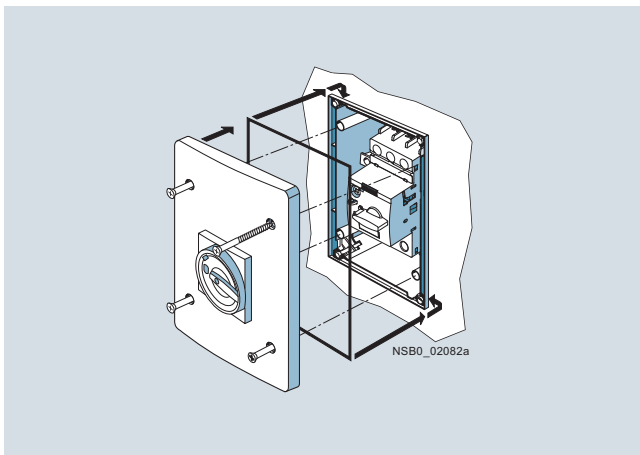

Enclosures (only for sizes S00 and S0)

All enclosures are equipped with N and PE terminals. There are two knock-out cable entries for cable glands at the top and two at the bottom; also on the rear corresponding cable entries are scored. There is a knockout on the top of the enclosure for indicator lights that are available as accessories.

The narrow enclosure can accommodate a motor starter protector without accessories, with transverse auxiliary switch and with lateral auxiliary switch. There is no provision for installing a motor starter protector with a signaling switch.

With size S00 to S2 circuit breakers the molded-plastic enclosures are equipped with a rotary operating mechanism.

The enclosures can be supplied with either a black rotary operating mechanism or with an EMERGENCY-STOP rotary operating mechanism with a red/yellow knob.

In the OFF setting, all rotary operating mechanisms can be locked with up to three padlocks.

Front plates

Motor starter protectors are frequently required to be actuated in any enclosure. Front plates equipped with a rotary operating mechanism for 3RV20 to 3RV24 motor starter protectors sizes S00 to S2 are available for this purpose.

A holder for the motor starter protectors size S00 and S0, into which the motor starter protectors can be snapped, is available for the front plates.

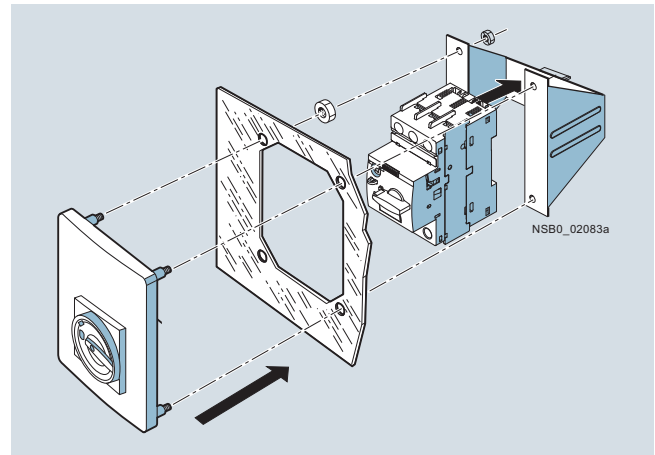

Front plate (including holder) for sizes S00 and S0

Motor Starter Protectors/Circuit Breakers

SIRIUS 3RV2 Motor Starter Protectors/Circuit Breakers up to 80 A

Accessories

Enclosures and front plates

Selection and ordering data

Version	Degree of protection	Integrated terminals	Width mm	For 3RV20 to 3RV24 motor starter protectors Size	DT	Article No.	Price per PU	PU (UNIT, SET, M)	PS*	PG
Molded-plastic enclosures for surface mounting¹⁾										
 3RV1933-1DA00	With rotary operating mechanism, lockable in 0 position	IP55	N and PE/ground	54 (for motor starter protector + lateral auxiliary switch)	S00, S0 ▶	3RV1923-1CA00		1	1 unit	41E
				72 (for motor starter protector + lateral auxiliary switch ²⁾ + auxiliary release)	S00, S0 ▶	3RV1923-1DA00		1	1 unit	41E
				82 (for motor starter protector + lateral auxiliary switch ²⁾ + auxiliary release)	S2 A	3RV1933-1DA00		1	1 unit	41E
 3RV1923-1FA00, 3RV1933-1GA00	With EMERGENCY-STOP rotary operating mechanism, lockable in 0 position	IP55	N and PE/ground	54 (for motor starter protector + lateral auxiliary switch)	S00, S0 ▶	3RV1923-1FA00		1	1 unit	41E
				72 (for motor starter protector + lateral auxiliary switch ²⁾ + auxiliary release)	S00, S0 ▶	3RV1923-1GA00		1	1 unit	41E
				82 (for motor starter protector + lateral auxiliary switch ²⁾ + auxiliary release)	S2 A	3RV1933-1GA00		1	1 unit	41E
Cast aluminum enclosures for surface mounting¹⁾										
 3RV1923-1DA01	With rotary operating mechanism, lockable in 0 position	IP65	PE ³⁾	72 (for motor starter protector + lateral auxiliary switch ²⁾ + auxiliary release)	S00, S0 ▶	3RV1923-1DA01		1	1 unit	41E
				72 (for motor starter protector + lateral auxiliary switch ²⁾ + auxiliary release)	S00, S0 ▶	3RV1923-1GA01		1	1 unit	41E
Molded-plastic enclosures for flush mounting⁴⁾										
 3RV1923-2DA00	With rotary operating mechanism, lockable in 0 position	IP55 (front side)	N and PE/ground	72 (for motor starter protector + lateral auxiliary switch ²⁾ + auxiliary release)	S00, S0 A	3RV1923-2DA00		1	1 unit	41E
				72 (for motor starter protector + lateral auxiliary switch ²⁾ + auxiliary release)	S00, S0 A	3RV1923-2GA00		1	1 unit	41E

1) The rear cable glands cannot be used on 3RV2.11-...2. and 3RV2.21-...2. devices with spring-type terminals.

2) Only valid for lateral auxiliary switches with two auxiliary contacts.

3) If required, an additional N terminal can be mounted (e.g. 8WA1011-1BG11).

4) Not suitable for 3RV2.11-...2. and 3RV2.21-...2. devices with spring-type terminals.

Motor Starter Protectors/Circuit Breakers

SIRIUS 3RV2 Motor Starter Protectors/Circuit Breakers up to 80 A

Accessories

Enclosures and front plates

Version	Degree of protection	For 3RV20 to 3RV24 motor starter protectors	DT	Article No.	Price per PU	PU (UNIT, SET, M)	PS*	PG
---------	----------------------	---	----	-------------	--------------	-------------------	-----	----

Front plates



3RV1923-4B +
3RV1923-4G

Molded-plastic front plates with rotary operating mechanism, lockable in 0 position For actuation of 3RV2 motor starter protectors in any enclosure	IP55 (front side)	S00 ... S2	▶	3RV1923-4B		1	1 unit	41E
Molded-plastic front plates with EMERGENCY-STOP rotary operating mechanism, red/yellow, lockable in 0 position EMERGENCY-STOP actuation of 3RV2 motor starter protectors in any enclosure	IP55 (front side)	S00 ... S2	A	3RV1923-4E		1	1 unit	41E
Holders for front plates Holder is mounted on front plate, motor starter protector with and without accessories is snapped in.	--	S00, S0	▶	3RV1923-4G		1	1 unit	41E

Version	Rated control supply voltage U_s	For 3RV20 to 3RV24 motor starter protectors	DT	Article No.	Price per PU	PU (UNIT, SET, M)	PS*	PG
---------	------------------------------------	---	----	-------------	--------------	-------------------	-----	----

Indicator lights



3RV1903-5B

Indicator lights For all enclosures and front plates • With LED lamp for versions 110 ... 120 V, with glow lamp for versions 220 ... 500 V • With colored lenses red, green, yellow, orange and clear	110 ... 120	S00 ... S2	C	3RV1903-5B		1	1 unit	41E
	220 ... 240		C	3RV1903-5C		1	1 unit	41E
	380 ... 415		C	3RV1903-5E		1	1 unit	41E
	480 ... 500		C	3RV1903-5G		1	1 unit	41E

Motor Starter Protectors/Circuit Breakers

SIRIUS 3RV2 Motor Starter Protectors/Circuit Breakers up to 80 A

3RV29 infeed system

Overview

The 3RV29 infeed system is a convenient means of energy supply and distribution for a group of several motor starter protectors or complete load feeders with a screw or spring-type connection in sizes S00 and S0 (exception: this system cannot be used for the 3RV21, 3RV27 and 3RV28 motor starter protectors/circuit breakers).

The system is based on a basic module complete with a lateral incoming unit (three-phase busbar with infeed). This infeed with spring-type terminals is mounted on the right or left depending on the version and can be supplied with a maximum conductor cross-section of 25 mm² (with end sleeve). A basic module has two sockets onto each of which a motor starter protector can be snapped.

Expansion modules are available for extending the system (three-phase busbars for system expansion). The individual modules are connected through an expansion plug.

The electrical connection between the three-phase busbars and the motor starter protectors is implemented through plug-in connectors. The complete system can be mounted on a TH 35 stan-

dard mounting rail to IEC 60715 and can be expanded as required up to a maximum current carrying capacity of 63 A.

The system is mounted extremely quickly and easily thanks to the simple plug-in technique. Thanks to the lateral infeed, the system also saves space in the control cabinet. The additional overall height required for the infeed unit is only 30 mm. The alternative infeed possibilities on each side offer a high degree of flexibility for configuring the control cabinet: Infeed on left-hand or right-hand side as well as infeed on one side and outfeed on the other side to supply further loads are all possible. A terminal block with spring-type connections in combination with a standard mounting rail enables the integration of not only SIRIUS motor starter protectors but also single-phase, 2-phase and 3-phase components such as 5SY miniature circuit breakers or SIRIUS relay components.

The 3RV29 infeed system is approved in accordance with IEC to 500 V. It is also UL-approved and authorized for "Self-Protected Combination Motor Controller" (Type E starter) as well as for Type F starter (Type E starter + contactor).

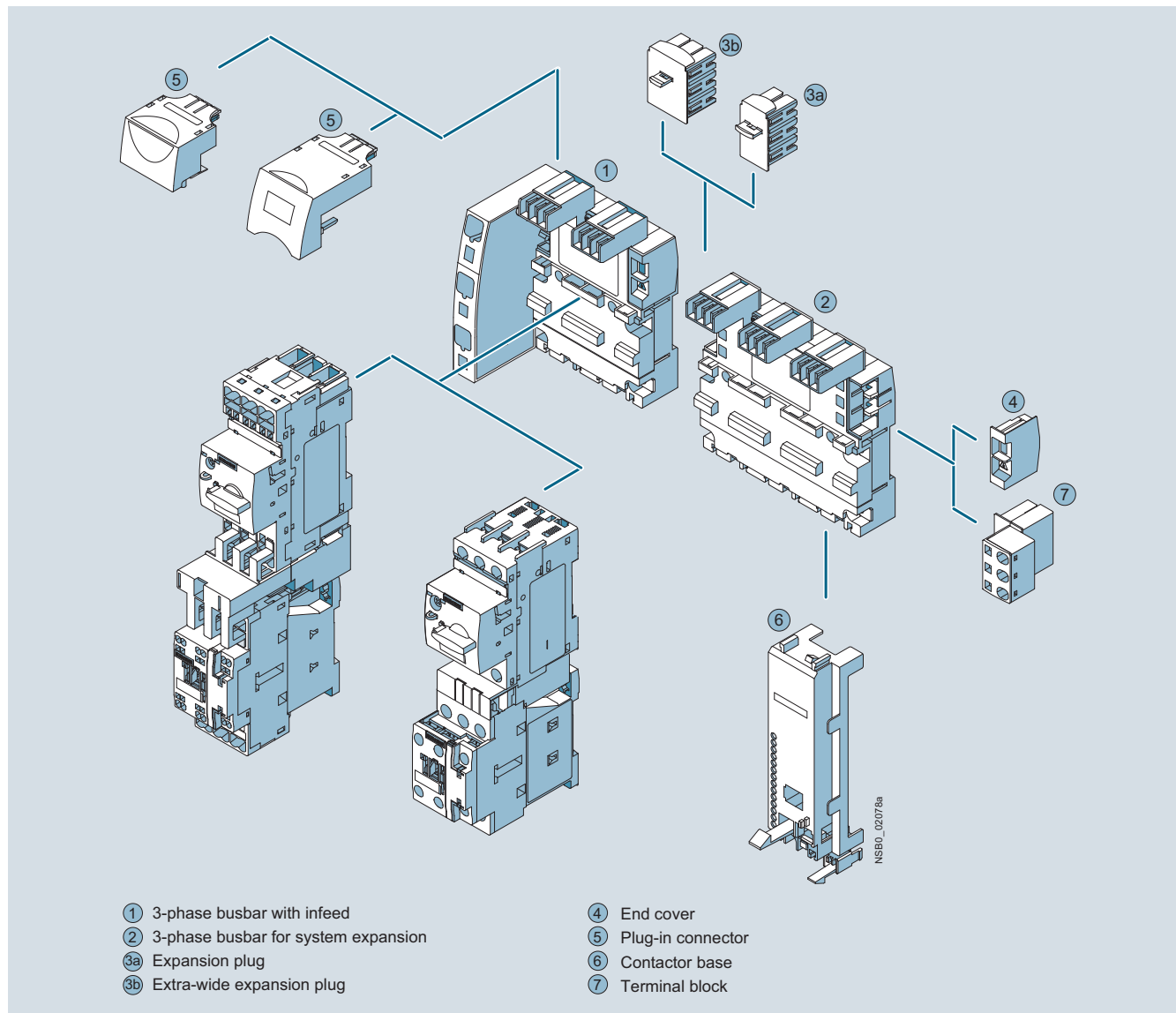

SIRIUS 3RV29 infeed systems

Motor Starter Protectors/Circuit Breakers

SIRIUS 3RV2 Motor Starter Protectors/Circuit Breakers up to 80 A

3RV29 infeed system

① **Three-phase busbars with infeed**

A three-phase busbar with infeed unit is required for connecting the incoming supply. These modules comprise one infeed module and two sockets which each accept one motor starter protector. A choice of two versions with infeed on the left or right is available. The infeed is connected to spring-type terminals. They permit an infeed with conductor cross-sections of up to 25 mm² with end sleeves. An end cover is supplied with each module.

② **Three-phase busbars for system expansion**

The three-phase busbars for system expansion support expansion of the system. There is a choice of modules with two or three sockets. The system can be expanded as required up to a maximum current carrying capacity of 63 A. An expansion plug is supplied with each module.

③a **Expansion plug**

The expansion plug is used for electrical connection of adjacent three-phase busbars. The current carrying capacity of this plug equals 63 A. One expansion plug is supplied with each three-phase busbar for system expansion. Additional expansion plugs are therefore only required as spare parts.

③b **Extra-wide expansion plug**

The wide expansion plug makes the electrical connection between two three-phase busbars, thus performing the same function as the 3RV2917-5BA00 expansion plug; the electrical characteristics (e.g. a current carrying capacity of 63 A) are identical.

The 3RV2917-5E expansion plug is 10 mm wider than the 3RV2917-5BA00 expansion plug, hence in the plugged state there is a distance of 10 mm between the connected three-phase busbars. This distance can be used to lay the auxiliary current and control current wiring ("wiring duct"). The motor starter protector and contactor can be wired from underneath, which means that the complete cable duct above the system can be omitted.

④ **End cover**

The end cover is used to cover the three-phase busbar at the open end of the system. This cover is therefore only required once for each system. An end cover is supplied with each three-phase busbar system with infeed. Further end covers are therefore only required as spare parts.

⑤ **Plug-in connector**

The plug-in connector is used for the electrical connection between the three-phase busbar and the 3RV2 motor starter protector. These plug-in connectors are available for screw or spring-type terminals.

⑥ **Contactor base**

Load feeders can be assembled in the system using the S00 and S0 contactor base. The contactor bases are suitable for contactors sizes S00 and S0 with spring-type and screw terminals and are simply snapped onto the three-phase busbars. Direct-on-line starters and reversing starters are possible. One contactor base is required for direct-on-line starters and two are required for reversing starters.

To assemble load feeders for reversing starters, the contactor bases can be arranged alongside each other (90 mm overall width). In this case the mechanical interlocking of the contactors is possible. The S0 contactor bases are also suitable for soft starters size S00 and S0 with screw terminal.

The infeed system is designed for mounting onto a TH 35 standard mounting rail with 7.5 mm overall depth. This standard mounting rail gives the contactor base a stable mounting surface to sit on. If standard mounting rails with a depth of 15 mm are used, the spacer connected to the bottom of the contactor base must be knocked out and plugged into the mating piece that is also on the underside. Then the contactor base also has a stable mounting surface. When standard mounting rails with a depth of 7.5 mm are used, the spacer has no function and can be removed.

The link modules are used for direct start load feeders, in which case the use of a contactor base is not absolutely necessary. Motor starter protector and contactor assemblies can then be directly snapped onto the sockets of the three-phase busbars. For feeders of sizes S00 and S0, the corresponding 3RA1921-1....., 3RA2911-2....., 3RA2921-1..... or 3RA2921-2..... link modules should generally be used.

⑦ **Terminal block**

The 3RV2917-5D terminal block enables the integration of not only SIRIUS motor starter protectors but also single-phase, 2-phase and 3-phase components. The three phases can be fed out of the system using the terminal block; which means that single-phase loads can also be integrated in the system. The terminal block is plugged into the slot of the expansion plug and thus enables outfeeding from the middle or end of the infeed system. The terminal block can be rotated through 180° and be locked to the support modules of the infeed system. In addition, the 45 mm wide TH 35 3RV1917-7B standard mounting rail option for screwing onto the support plate facilitates plugging the single-phase, two-phase and three-phase components onto the infeed system.



Motor Starter Protectors/Circuit Breakers

SIRIUS 3RV2 Motor Starter Protectors/Circuit Breakers up to 80 A

3RV29 infeed system

Technical specifications

General data					
Type		3RV29.7			
Size		S00, S0			
Standards					
• IEC 60947-2		Yes			
• IEC 60947-4-1		Yes			
• UL 508/JUL 60947-4-1		Yes			
Rated current I_n		A		63	
Permissible rated current at inside temperature of control cabinet					
Motor starter protectors	Size	Rated current	Inside temperature of control cabinet		
• 3RV2.11	S00	... 14 A	60 °C	%	100
		>14 ... 16 A	40 °C	%	100
			60 °C	%	87
• 3RV2.21	S0	... 16 A	60 °C	%	100
		> 16 ... 25 A	40 °C	%	100
			60 °C	%	87
		> 25 ... 32 A	40 °C	%	87
Permissible ambient temperature					
• Storage/transport		°C		-50 ... +80	
• Operation		°C		-20 ... +60	
Rated operational voltage U_e					
• Acc. to IEC	10 % overvoltage	V AC	500		
	5% overvoltage	V AC	525		
• Acc. to UL/CSA		V AC	600		
Rated frequency		Hz		50/60	
Rated impulse withstand voltage U_{imp}		kV		6	
Short-circuit strength		Corresponds to the mounted motor starter protector or load feeder			
Degree of protection acc. to IEC 60529		IP20 (In the terminal compartment of the infeed without connected IP00 conductor)			
Touch protection acc. to DIN VDE 0106, Part 100		Finger-safe			

Conductor cross-sections

Type		Three-phase busbar with infeed 3RV2917-1A, 3RV2917-1E	Terminal block 3RV2917-5D
Conductor cross-sections (min./max.)			
• Solid or stranded	mm ²	4 ... 25	1.5 ... 6
• Finely stranded with end sleeve	mm ²	4 ... 25	1.5 ... 4
• Finely stranded without end sleeve	mm ²	6 ... 25	1.5 ... 6
• AWG cables	AWG	10 ... 3	15 ... 10

Motor Starter Protectors/Circuit Breakers

SIRIUS 3RV2 Motor Starter Protectors/Circuit Breakers up to 80 A

3RV29 infeed system

Selection and ordering data

Type	Version	For 3RV20, 3RV23, 3RV24 motor starter protectors Size	DT	Article No.	Price per PU	PU (UNIT, SET, M)	PS*	PG
------	---------	--	----	-------------	--------------	-------------------	-----	----

Three-phase busbars with infeed

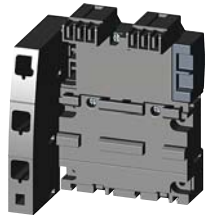

3RV2917-1A

Three-phase busbars with infeed

incl. 3RV2917-6A end cover

For 2 motor starter protectors with screw or spring-type terminals

- With infeed on the left S00, S0 A
- With infeed on the right S00, S0 A

3RV2917-1A
3RV2917-1E

1 1 unit 41E
1 1 unit 41E

Three-phase busbars for system expansion

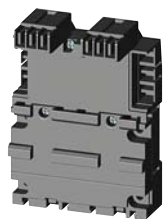

3RV2917-4A

Three-phase busbars

incl. 3RV2917-5BA00 expansion plug

For motor starter protectors with screw or spring-type terminals

- For 2 motor starter protectors S00, S0 A
- For 3 motor starter protectors S00, S0 A

3RV2917-4A
3RV2917-4B

1 1 unit 41E
1 1 unit 41E

Plug-in connectors



3RV2917-5AA00

Plug-in connectors

to make contact with the motor starter protectors

- For spring-type terminals
 - Single-unit packaging S00¹⁾ A
 - Multi-unit packaging S00¹⁾ S0²⁾ A

Spring-type terminals



3RV2917-5AA00
3RV2927-5AA00
3RV2917-5A
3RV2927-5A

1 1 unit 41E
1 1 unit 41E
1 10 units 41E
1 10 units 41E



3RV2917-5CA00

- For screw terminals

Screw terminals



3RV2917-5CA00
3RV1927-5AA00
3RV2917-5C
3RV1927-5A

1 1 unit 41E
1 1 unit 41E
1 10 units 41E
1 10 units 41E

¹⁾ $I > 14$ A, please note derating; see Manual "SIRIUS Innovations – SIRIUS 3RV2 Motor Starter Protectors", <http://support.automation.siemens.com/WW/view/en/60279172>.

²⁾ $I > 16$ A, please note derating; see Manual "SIRIUS Innovations – SIRIUS 3RV2 Motor Starter Protectors", <http://support.automation.siemens.com/WW/view/en/60279172>.

Type	Version	For contactors Size	DT	Article No.	Price per PU	PU (UNIT, SET, M)	PS*	PG
------	---------	------------------------	----	-------------	--------------	-------------------	-----	----

Contactors bases



3RV2927-7AA00

Contactors bases

for mounting direct-on-line or reversing starters

- Single-unit packaging S00 A
- S00, S0 A

3RV2917-7AA00
3RV2927-7AA00

1 1 unit 41E
1 1 unit 41E

Motor Starter Protectors/Circuit Breakers

SIRIUS 3RV2 Motor Starter Protectors/Circuit Breakers up to 80 A

3RV29 infeed system

Type	Version	DT	Article No.	Price per PU	PU (UNIT, SET, M)	PS*	PG
Terminal blocks							
	Terminal blocks For integration of single-phase, two-phase and three-phase components	Single-unit packaging	A	3RV2917-5D	1	1 unit	41E
3RV2917-5D							
TH 35 standard mounting rails, width 45 mm							
	TH 35 standard mounting rails acc. to IEC 60715, width 45 mm For mounting onto three-phase busbars	Single-unit packaging	A	3RV1917-7B	1	1 unit	41E
3RV1917-7B							
Extra-wide expansion plugs							
	Extra-wide expansion plugs As accessory	Single-unit packaging	A	3RV2917-5E	1	1 unit	41E
3RV2917-5E							
Expansion plugs							
	Expansion plugs¹⁾ As spare part	Single-unit packaging	A	3RV2917-5BA00	1	1 unit	41E
3RV2917-5BA00							
End covers							
	End covers²⁾ As spare part	Multi-unit packaging	A	3RV2917-6A	100	10 units	41E
3RV2917-6A							

¹⁾ The expansion plug is included in the scope of supply of the 3RV2917-4, three-phase busbars for system expansion.

²⁾ The end cover is included in the scope of supply of the 3RV2917-1, three-phase busbars with infeed system.

Motor Starter Protectors/Circuit Breakers

SIRIUS 3RV1 Motor Starter Protectors/Circuit Breakers up to 100 A

General data

Overview

The following illustration shows our 3RV1 motor starter protector/circuit breaker with the accessories which can be mounted for size S3, see also "Introduction" → "Overview", page 7/3.

"Accessories", see page 7/69 onwards.

Note:

The 3RV1 devices (sizes S00/S0 to S3) can be found

- in the Catalog Add-On IC 10 AO · 2015 at the Information and Download Center
- in the interactive catalog CA 01
- in the Industry Mall

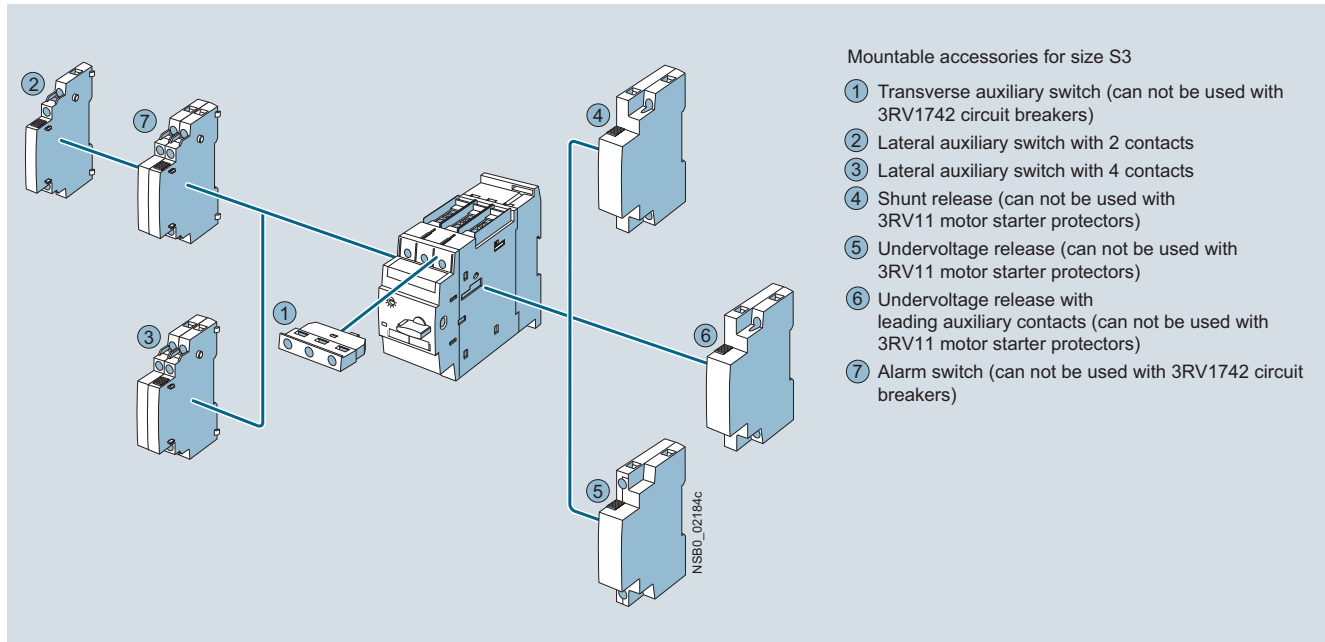

SIRIUS 3RV1 motor starter protector/circuit breaker size S3 with mountable accessories



SIRIUS motor starter protector/circuit breaker size S3

3RV1 motor starter protectors/circuit breakers are compact, current limiting motor starter protectors/circuit breakers which are optimized for load feeders. The motor starter protectors/circuit breakers are used according to IEC 60947-2 for switching and protecting three-phase motors of up to 45 kW at 400 V AC and for other loads with rated currents of up to 100 A.

3RV2 motor starter protectors/circuit breakers sizes S00 to S2 up to 80 A, see page 7/21 onwards.

3RV1 motor starter protectors/circuit breakers are generally approved according to IEC and UL/CSA.

According to UL 508/UL 60947-4-1, the 3RV1 motor starter protectors in size S3 are approved as:

- "Manual Motor Controllers"
- "Manual Motor Controllers" for "Group Installations"
- "Manual Motor Controllers Suitable for Tab Conductor Protection in Group Installations"
- "Self-Protected Combination Motor Controllers (Type E)"
Please note that for this approval the 3RV10 motor starter protectors in size S3 must be equipped with additional infeed terminals.

The 3RV1742 are approved as circuit breakers according to UL 489; they are a special variant of the 3RV1 motor starter protectors.

Corresponding short-circuit values, see pages 7/54 to 7/57.

Motor Starter Protectors/Circuit Breakers

SIRIUS 3RV1 Motor Starter Protectors/Circuit Breakers up to 100 A

General data

Type of construction

The 3RV1 motor starter protectors/circuit breakers are available in four sizes:

- Size S00 – width 45 mm, max. rated current 12 A, at 400 V AC suitable for three-phase motors up to 5.5 kW
- Size S0 – width 45 mm, max. rated current 25 A, at 400 V AC suitable for three-phase motors up to 11 kW
- Size S2 – width 55 mm, max. rated current 50 A, at 400 V AC suitable for three-phase motors up to 22 kW
- Size S3 – width 70 mm, max. rated current 100 A, at 400 V AC suitable for three-phase motors up to 45 kW

Sizes S00 to S2 of the 3RV2 motor starter protectors/circuit breakers up to 80 A, [see page 7/21 onwards](#).

Circuit breakers acc. to UL 489

The 3RV1742 circuit breakers are available in size S3 (width 70 mm):

- Maximum rated current 70 A at 480 Y/277 V AC
- Maximum rated current 10 A to 30 A at 480 V AC

For sizes S00 and S0 of the 3RV27 and 3RV28 circuit breakers up to 22 A, [see pages 7/29 and 7/30](#).

Article No. scheme

Digit of the Article No.	1st - 3rd	4th	5th	6th	7th	8th	9th	10th	11th	12th	13th	14th	15th	16th	
	□□□	□	□	□	□	-	□	□	□	□	-	□	□	□	
Motor starter protectors/circuit breakers	3 R V														
SIRIUS 1st generation	1														
Type of motor starter protector/circuit breaker	□														
Size	□														
Breaking capacity	□														
Setting range for overload release	□ □														
Trip class (CLASS)	□														
Connection methods	□														
With or without auxiliary switch	□														
Special versions	□ □ □ □														
Example	3 R V	1	0	4	1	-	4	F	A	1	0				

Note:

The Article No. scheme is presented here merely for information purposes and for better understanding of the logic behind the article numbers.

For your orders, please use the article numbers quoted in the catalog in the Selection and ordering data.

Connection methods

The SIRIUS 3RV1 motor starter protectors/circuit breakers can be supplied with screw terminals and spring-type terminals.



Screw terminals



Spring-type terminals

The terminals are indicated in the corresponding tables by the symbols shown on orange backgrounds.

"Increased safety" type of protection EEx e according to ATEX directive 94/9/EC

3RV10 motor starter protectors are suitable for the overload protection of explosion-proof motors with "increased safety" type of protection EEx e.

Application

Operating conditions

3RV1 motor starter protectors/circuit breakers are suitable for use in any climate. They are intended for use in enclosed rooms in which no severe operating conditions (such as dust, caustic vapors, hazardous gases) prevail. When installed in dusty and damp areas, suitable enclosures must be provided.

3RV1 motor starter protectors/circuit breakers can optionally be fed from the top or from below.

The permissible ambient temperatures, the maximum switching capacities, the tripping currents and other boundary conditions can be found in the technical specifications and tripping characteristics, see Reference Manual "Protection Equipment – Circuit Breakers · Molded Case Circuit Breakers", <http://support.automation.siemens.com/WW/view/en/65032586>.

3RV1 motor starter protectors/circuit breakers are suitable for operation in IT systems (IT networks). In this case, the different short-circuit breaking capacity in the IT system must be taken into account, see page 7/55.

Since operational currents, starting currents and current peaks are different even for motors with identical power ratings due to the inrush current, the motor ratings in the selection tables are only guide values. The specific rated and startup data of the motor to be protected is always paramount to the choice of the most suitable motor starter protector/circuit breaker. This also applies to motor starter protectors for transformer protection.

Note:

For the use of 3RV1 motor starter protectors in size S3 in conjunction with highly energy-efficient IE3 motors, please observe the information on dimensioning and configuring, see "Configuration Manual for SIRIUS Controls with IE3 Motors", <http://support.automation.siemens.com/WW/view/en/94770820>.

More information, see page 3.

Possible uses

The 3RV1 motor starter protectors/circuit breakers can be used:

- For short-circuit protection
- For motor protection (also with overload relay function)
- For system protection
- For short-circuit protection for starter combinations
- As main and EMERGENCY-STOP switches
- For fuse monitoring
- For operation in IT systems (IT networks)
- For switching of DC currents
- As voltage transformer circuit breakers
- In areas subject to explosion hazard (ATEX)
- Approved as circuit breakers according to UL 489 (3RV1742)

For more details, see Reference Manual "Protection Equipment – Circuit Breakers · Molded Case Circuit Breakers" <http://support.automation.siemens.com/WW/view/en/65032586>.

Motor Starter Protectors/Circuit Breakers

SIRIUS 3RV1 Motor Starter Protectors/Circuit Breakers up to 100 A

General data

Technical specifications

Short-circuit breaking capacity I_{cu} , I_{cs} according to IEC 60947-2

This table shows the rated ultimate short-circuit breaking capacity I_{cu} and the rated service short-circuit breaking capacity I_{cs} of the 3RV1 motor starter protectors/circuit breakers with different operating voltages dependent of the rated current I_n of the motor starter protectors/circuit breakers.

Power can be supplied to the motor starter protectors/circuit breakers via the terminals at the top or at the bottom without restricting the rated data. If the short-circuit current at the place of installation exceeds the rated short-circuit breaking capacity of the motor starter protector/circuit breaker as specified in the table, a back-up fuse is required. It is also possible to install an upstream motor starter protector/circuit breaker with a limiter function.

The maximum rated current of this back-up fuse is indicated in the tables. The rated ultimate short-circuit breaking capacity then applies as specified on the fuse.

Fuseless design

Motor starter protector/contactors assemblies for short-circuit currents up to 100 kA can be ordered as fuseless load feeders, see Chapter 8 "Load Feeders and Motor Starters for Use in the Control Cabinet".

Motor starter protectors/circuit breakers	Rated current I_n	Up to 240 V AC ¹⁾			Up to 400 V AC ^{1)/} 415 V AC ²⁾			Up to 440 V AC ^{1)/} 460 V AC ²⁾			Up to 500 V AC ^{1)/} 525 V AC ²⁾			Up to 690 V AC ¹⁾		
		I_{cu}	I_{cs}	Max. fuse (gG)	I_{cu}	I_{cs}	Max. fuse (gG) ³⁾	I_{cu}	I_{cs}	Max. fuse (gG) ³⁾	I_{cu}	I_{cs}	Max. fuse (gG) ³⁾	I_{cu}	I_{cs}	Max. fuse (gG) ^{3)/4)}
Type	A	kA	kA	A	kA	kA	A	kA	kA	A	kA	kA	A	kA	kA	A
<i>(these values do not apply to 3RV1742 circuit breakers)</i>																
Size S00																
3RV1611-0BD10	0.2	100	100	°	100	100	°	100	100	°	100	100	°	100	100	°
Size S3																
3RV1.41	40	100	100	°	50	25	125	50	20	125	12	6	100	6	3	63
	50	100	100	°	50	25	125	50	20	125	12	6	100	6	3	80
	63	100	100	°	50	25	160	50	20	160	12	6	100	6	3	80
	75	100	100	°	50	25	160	50	20	160	8	4	125	5	3	100
	90; 100	100	100	°	50	25	160	50	20	160	8	4	125	5	3	125
Size S3, with increased switching capacity																
3RV1.42/3RV1742 ⁵⁾	16 / 10	100	100	°	100	50	°	100	50	°	30	15	80	12	7	63
	20 / 15	100	100	°	100	50	°	100	50	°	30	15	80	12	7	63
	25 / 20	100	100	°	100	50	°	100	50	°	30	15	80	12	7	63
	32 / 25	100	100	°	100	50	°	100	50	°	22	11	100	12	7	63
	40 / 30	100	100	°	100	50	°	100	50	°	18	9	160	12	6	80
	50 / 35 ... 40	100	100	°	100	50	°	100	50	°	15	7.5	160	10	5	100
	63 / 45 ... 50	100	100	°	100	50	°	70	50	200	15	7.5	160	7.5	4	100
	75 / 60	100	100	°	100	50	°	70	50	200	10	5	160	6	3	125
	90 / 70	100	100	°	100	50	°	70	50	200	10	5	160	6	3	160
	100 / --	100	100	°	100	50	°	70	50	200	10	5	160	6	3	160

° No back-up fuse required, since short-circuit resistant up to 100 kA

1) 10 % overvoltage.

2) 5 % overvoltage.

3) Back-up fuse only required if short-circuit current at the place of installation > I_{cu} .

4) Alternatively, fuseless limiter combinations for 690 V AC can also be used.

5) The values for the 3RV1742 circuit breakers have been tested only up to 400 V/415 V AC; values > 440 V AC on request.

Motor Starter Protectors/Circuit Breakers

SIRIUS 3RV1 Motor Starter Protectors/Circuit Breakers up to 100 A

General data

Short-circuit breaking capacity I_{cuIT} in the IT system (IT network) according to IEC 60947-2

3RV1 motor starter protectors/circuit breakers are suitable for operation in IT systems. The values of I_{cu} and I_{cs} apply for the three-pole short circuit. In case of a double ground fault in different phases at the input and output side of a motor starter protector/circuit breaker, the special short-circuit breaking capacity I_{cuIT} applies. The specifications in the table apply to 3RV1 motor starter protectors/circuit breakers.

If the short-circuit current at the place of installation exceeds the motor starter protector/circuit breaker's specified rated short-circuit breaking capacity, you will need to use a back-up fuse. The maximum rated current of this back-up fuse is indicated in the tables. The rated short-circuit breaking capacity then applies as specified on the fuse.

Motor starter protectors/circuit breakers	Rated current I_n	Up to 240 V AC ¹⁾		Up to 400 V AC ¹⁾ /415 V AC ²⁾		Up to 500 V AC ¹⁾ /525 V AC ²⁾		Up to 690 V AC ¹⁾⁵⁾	
		I_{cuIT}	Max. fuse (gG) ³⁾	I_{cuIT}	Max. fuse (gG) ³⁾⁴⁾	I_{cuIT}	Max. fuse (gG) ³⁾	I_{cuIT}	Max. fuse (gG) ³⁾
Type	A	kA	A	kA	A	kA	A	kA	A
Size S00									
3RV1611-0BD10	0.2	100	°	100	°	100	°	100	°
Size S3									
3RV1.41	40	50	125	10	63	5	50	5	50
	50	50	125	8	80	3	63	3	63
	63	50	160	6	80	3	63	3	63
	75	50	160	5	100	2	80	2	80
	90; 100	50	160	5	125	2	100	2	100
Size S3, with increased switching capacity									
3RV1.42	16 ... 32	100	°	12	63	6	50	6	50
	40	100	°	12	80	6	63	6	63
	50	100	°	10	100	4	80	4	80
	63	100	°	7.5	100	4	80	4	80
	75	100	°	6	125	3	100	3	100
	90; 100	100	°	6	160	3	125	3	125

° No back-up fuse required, since short-circuit resistant up to 100 kA

1) 10 % overvoltage.

2) 5 % overvoltage.

3) Back-up fuse only required if short-circuit current at the place of installation > I_{cuIT} .

4) Alternatively, fuseless limiter combinations for 690 V AC can also be used.

5) Overvoltage category II applies for applications in IT systems > 600 V.

Limiter function with standard devices for 500 V AC and 690 V AC according to IEC 60947-2

The table shows the rated ultimate short-circuit breaking capacity I_{cu} and the rated service short-circuit breaking capacity I_{cs} with an upstream standard motor starter protector that fulfills the limiter function at voltages 500 V AC and 690 V AC.

The short-circuit breaking capacity can be increased significantly with an upstream standard motor starter protector with limiter function. The motor starter protector which is connected downstream must be set to the rated current of the load.

With motor starter protector assemblies, note the clearance to grounded parts and between the motor starter protectors. Short-circuit proof wiring between the motor starter protectors must be ensured. The motor starter protectors can be mounted side by side in a modular arrangement.

Standard motor starter protectors	With limiter rated current I_n	Rated current I_n	Up to 500 V AC ¹⁾ /525 V AC ²⁾		Up to 690 V AC ¹⁾	
			I_{cu}	I_{cs}	I_{cu}	I_{cs}
Type	Type	A	kA	kA	kA	kA
Size S3						
3RV1041/3RV10 42	3RV1341-4HC10	32 ... 50	100	50	50	25
	$I_n = 50$ A					
	3RV1341-4MC10	50 ... 100	100	50	50	25
	$I_n = 100$ A					

1) 10 % overvoltage.

2) 5 % overvoltage.

Motor Starter Protectors/Circuit Breakers

SIRIUS 3RV1 Motor Starter Protectors/Circuit Breakers up to 100 A

General data

Permissible rated data of approved devices for North America (UL/CSA)

Motor starter protectors/circuit breakers of the 3RV1 series are approved for UL/CSA, and according to UL508/UL 60947-4-1 and CSA C22.2 No. 14/CSA 60947-4-1 they can be used on their own or as load feeders in combination with a contactor.

These motor starter protectors/circuit breakers can be used as "Manual Motor Controllers" for "Group Installations", as "Manual Motor Controllers Suitable for Tap Conductor Protection in Group Installations" and as "Self-Protected Combination Motor Controllers" (Type E).

3RV1 motor starter protectors/circuit breakers as "Manual Motor Controllers"

If used as a "Manual Motor Controller", the motor starter protector/circuit breaker is always operated in combination with an upstream short-circuit protection device. Approved fuses or a circuit breaker according to UL 489/CSA C22.2 No. 5 can be used. These devices must be dimensioned according to the National Electrical Code (UL) or Canadian Electrical Code (CSA).

The file numbers for the approval of the 3RV1 as a Manual Motor Controller are as follows:

- UL File No. 47705, CCN: NLRV
- CSA Master Contract 165071, Product Class: 3211 05

Motor starter protectors		hp rating ¹⁾ for FLA ²⁾ max.		Rated current I_n	240 V AC		480 V AC		600 V AC	
					UL $I_{bc}^{(3)}$ kA	CSA $I_{bc}^{(3)}$ kA	UL $I_{bc}^{(3)}$ kA	CSA $I_{bc}^{(3)}$ kA	UL $I_{bc}^{(3)}$ kA	CSA $I_{bc}^{(3)}$ kA
Type	V	Single-phase	3-phase	A						
Size S00										
3RV1611-0BD10				0.2	65	65	65	65	10	10
Size S3										
3RV1041/3RV1042, 3RV1142, 3RV1341/3RV1342				16 ... 75 90; 100	65 65	65 65	65 65	65 65	30 10	30 10
FLA ²⁾ max.	115	7 1/2	--							
100 A, 600 V	200	20	30							
	230	20	40							
NEMA size 3	460	--	75							
	575/600	--	100							

1) hp rating = Power rating in horse power (maximum motor rating).

3) Corresponds to "short-circuit breaking capacity" according to UL/CSA.

2) FLA = Full Load Amps/motor full load current.

3RV10 motor starter protectors as "Manual Motor Controllers Suitable for Tap Conductor Protection in Group Installations"

The application as "Manual Motor Controllers Suitable for Tap Conductor Protection in Group Installations" is only available for UL. CSA does not recognize this approval! When the motor starter protector is used as a "Manual Motor Controller Suitable for Tap Conductor Protection in Group Installations", it must always be combined with upstream short-circuit protection. Approved fuses or a circuit breaker according to UL 489 can be used. These devices must be dimensioned according to the National Electrical Code.

The 3RV10 motor starter protectors are approved as "Manual Motor Controllers Suitable for Tap Conductor Protection in Group Installations" under the following file number:

- UL File No. 47705, CCN: NLRV

Motor starter protectors		hp rating ¹⁾ for FLA ²⁾ max.		Rated current I_n	240 V AC	Up to 480 Y/277 V AC	Up to 600 Y/347 V AC
					UL $I_{bc}^{(3)}$ kA	UL $I_{bc}^{(3)}$ kA	UL $I_{bc}^{(3)}$ kA
Type	V	Single-phase	3-phase	A			
Size S3							
3RV104.				16 ... 75 90; 100	65 65	65 65	30 --
FLA ²⁾ max.	115	7 1/2	--				
100 A, 480 V	200	20	30				
75 A, 600 V	230	20	40				
NEMA size 3	460	--	75				
	575/600	--	75				

-- No approval

1) hp rating = Power rating in horse power (maximum motor rating).

2) FLA = Full Load Amps/motor full load current.

3) Corresponds to "short-circuit breaking capacity" according to UL.

Motor Starter Protectors/Circuit Breakers

SIRIUS 3RV1 Motor Starter Protectors/Circuit Breakers up to 100 A

General data

3RV10 motor starter protectors as "Self-Protected Combination Motor Controllers (Type E)"

UL 508/UL 60947-4-1 approval demands 1-inch clearance and 2-inch creepage distance at line side for "Self-Protected Combination Motor Controller Type E".

Therefore, 3RV10 motor starter protectors in size S3 are approved according to UL 508/UL 60947-4-1 in combination with the 3RT1946-4GA07 terminal block listed below.

CSA does not require these extended clearances and creepage distances. According to CSA, these terminal blocks can be omitted when the device is used as a "Self-Protected Combination Motor Controller".

The 3RV10 motor starter protectors are approved as "Self-Protected Combination Motor Controllers" under the following file numbers:

- UL File No. E156943, CCN: NKJH
- CSA Master Contract 165071, Product Class: 3211 08

Motor starter protectors		hp rating ¹⁾ for FLA ²⁾ max.		Rated current I_n	Up to 240 V AC		Up to 480 Y/277 V AC		Up to 600 Y/347 V AC	
		Single-phase	Three-phase		UL $I_{bc}^{(3)}$	CSA $I_{bc}^{(3)}$	UL $I_{bc}^{(3)}$	CSA $I_{bc}^{(3)}$	UL $I_{bc}^{(3)}$	CSA $I_{bc}^{(3)}$
Type	V			A	kA	kA	kA	kA	kA	kA
Size S3										
3RV1041 + 3RT1946-4GA07⁴⁾				16 ... 75 90; 100	65 65	65 65	65 65	65 65	30 --	30 --
FLA ²⁾ max.	115	10	--							
100 A, 480 V	200	20	30							
75 A, 600 V	230	20	40							
NEMA size 3	460	--	75							
	575/600	--	75							

-- No approval

1) hp rating = Power rating in horse power (maximum motor rating).

2) FLA = Full Load Amps/motor full load current.

³⁾ Corresponds to "short-circuit breaking capacity" according to UL/CSA.

⁴⁾ Not required for CSA.

3RV1742 motor starter protectors as "Circuit Breakers"

These motor starter protectors are approved as circuit breakers according to UL 489 and CSA 22.2 No. 5. They can be used therefore as upstream short-circuit protective devices for "Manual Motor Controllers" and "Manual Motor Controllers Suitable for Tap Conductor Protection in Group Installations".

The 3RV1742 motor starter protectors are approved as "Circuit Breakers" under the following file numbers:

- UL File No. E235044, CCN: DIVQ
- CSA Master Contract 165071, Product Class: 1432 01

Circuit breakers	Rated current I_n	240 V AC		480 Y/277 V AC		480 V AC		600 Y/347 V AC		
		UL $I_{bc}^{(1)}$	CSA $I_{bc}^{(1)}$	UL $I_{bc}^{(1)}$	CSA $I_{bc}^{(1)}$	UL $I_{bc}^{(1)}$	CSA $I_{bc}^{(1)}$	UL $I_{bc}^{(1)}$	CSA $I_{bc}^{(1)}$	
Type	A	kA	kA	kA	kA	kA	kA	kA	kA	
Size S3										
3RV1742		10 ... 30	65	65	65	65	65	65	20	20
		35 ... 60	65	65	65	65	--	--	20	20
		70	65	65	65	65	--	--	10	10

-- No approval

¹⁾ Corresponds to "short-circuit breaking capacity" according to UL.

Motor Starter Protectors/Circuit Breakers

SIRIUS 3RV1 Motor Starter Protectors/Circuit Breakers up to 100 A

General data

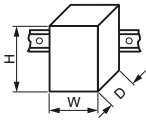
General data		3RV1611 ¹⁾	3RV1.4.	3RV1742
Type		S00	S3	S3
Size				
Dimensions (W x H x D)	 mm	45 x 90 x 70	70 x 165 x 169	70 x 168 x 169
Standards		Yes		No
• IEC 60947-1, EN 60947-1 (VDE 0660 Part 100)		Yes		No
• IEC 60947-2, EN 60947-2 (VDE 0660 Part 101)		Yes		No
• IEC 60947-4-1, EN 60947-4-1 (VDE 0660 Part 102)		Yes		Yes
• UL 508/UL 60947-4-1, CSA C22.2 No.14/CSA 60947-4-1		Yes		Yes
• UL 489, CSA C22.2 No. 5		No		Yes
Number of poles		3		
Max. rated current $I_{n \max}$ (= max. rated operational current I_{θ})	A	12	100	70
Permissible ambient temperature				
• Storage/transport	°C	-50 ... +80		
• Operation	°C	-20 ... +70 (current reduction above +60 °C)		
Permissible rated current at inside temperature of control cabinet				
• +60 °C	%	100		
• +70 °C	%	87		
Permissible rated current at ambient temperature of enclosure (applies for motor starter protector inside enclosure)				
• +35 °C	%	100		
• +60 °C	%	87		
Rated operational voltage U_e				
• Acc. to IEC	V AC	690 (with molded-plastic enclosure 500 V)		
• Acc. to UL/CSA	V AC	600		
Rated frequency	Hz	50/60		
Rated insulation voltage U_i	V	690		
Rated impulse withstand voltage U_{imp}	kV	6		
Utilization category				
• IEC 60947-2 (motor starter protector/circuit breaker)	A			
• IEC 60947-4-1 (motor starter)	AC-3			--
Trip class CLASS	Acc. to IEC 60947-4-1	10	10/20	--
DC short-circuit breaking capacity (time constant $t = 5$ ms)				
• 1 conducting path 150 V DC	kA	10		
• 2 conducting paths in series 300 V DC	kA	10		
• 3 conducting paths in series 450 V DC	kA	10		
Power loss P_v for each motor starter protector/circuit breaker	I_n : 16 ... 63 A	W	--	20
Dependent on the rated current I_n (upper setting range)				
$R_{\text{per conducting path}} = \frac{P}{I^2 \times 3}$	I_n : 75 and 90 A	W	--	30
	I_n : 100 A	W	--	38
	I_n : 10 A	W	--	8
	I_n : 15 ... 35 A	W	--	12
	I_n : 40 ... 70 A	W	--	21
Shock resistance	Acc. to IEC 60068-2-27	g/ms	25/11 (square and sine pulse)	
Degree of protection	Acc. to IEC 60529		IP20 (IP00 terminal compartment)	
Touch protection	Acc. to EN 50274		Finger-safe for vertical contact from the front	
Temperature compensation	Acc. to IEC 60947-4-1	°C	-20 ... +60	
Phase failure sensitivity	Acc. to IEC 60947-4-1		Yes (does not apply for 3RV134 motor starter protectors)	No
Explosion protection – Safe operation of motors with "increased safety" type of protection			Yes, for 3RV10 (CLASS 10)	No
EC type test certificate number according to directive 94/9/EC (ATEX)			DMT 02 ATEX F 001 Ex II (2) GD, DMT 02 ATEX F 001 N1 Ex II (2) GD	
Isolating function	Acc. to IEC 60947-2		Yes	
Main and EMERGENCY-STOP switch characteristics (with corresponding accessories)	Acc. to DIN EN 60204-1		Yes	
Protective separation between main and auxiliary circuits, required for PELV applications	Acc. to IEC 60947-1			
• Up to 400 V +10 %			Yes	
• Up to 415 V +5 % (higher voltages on request)			Yes	
Permissible mounting position			Any, acc. to IEC 60447 start command "I" right-hand side or top	
Mechanical endurance	Operating cycles		100 000	50 000
Electrical endurance	Operating cycles		100 000	25 000
Max. switching frequency per hour (motor starts)	1/h		15	



¹⁾ "Technical Specifications" for 3RV1611 voltage transformer circuit breakers, see page 7/60.

For short-circuit breaking capacity I_{cu} , I_{cs} see Reference Manual "Protection Equipment – Circuit Breakers · Molded Case Circuit Breakers" <http://support.automation.siemens.com/WW/view/en/65032586>.

Motor Starter Protectors/Circuit Breakers

SIRIUS 3RV1 Motor Starter Protectors/Circuit Breakers up to 100 A

General data

Conductor cross-sections of main circuit			
Type		3RV1611 ⁴⁾	3RV1.4./ 3RV1742
Connection type		 Screw terminals	 Screw terminals with box terminal
Terminal screw		Pozidriv size 2	4 mm Allen screw
Prescribed tightening torque	Nm	0.8 ... 1.2	4 ... 6
Conductor cross-sections (min./max.) , 1 or 2 conductors can be connected			
• Solid or stranded	mm ²	2 x (0.5 ... 1.5) ⁵⁾ , 2 x (0.75 ... 2.5) ⁵⁾	2 x (2.5 ... 16) ⁵⁾ , 2 x (10 ... 50) ⁵⁾ , 1 x (10 ... 70) ⁵⁾
• Finely stranded with end sleeve (DIN 46228-1)	mm ²	2 x (0.5 ... 1.5) ⁵⁾ , 2 x (0.75 ... 2.5) ⁵⁾	2 x (2.5 ... 35) ⁵⁾ , 1 x (2.5 ... 50) ⁵⁾
• AWG cables, solid or stranded	AWG	2 x (18 ... 14)	2 x (10 ... 1/0) ⁵⁾ , 1 x (10 ... 2/0) ⁵⁾
Ribbon cable conductors (Number x Width x Thickness)	mm	--	2 x (6 x 9 x 0.8)
Removable box terminals¹⁾			
• With copper bars ²⁾		--	18 x 10
• With cable lugs ³⁾		--	up to 2 x 70

1) Cable lug and busbar connection possible after removing the box terminals.

2) If bars larger than 12 mm x 10 mm are connected, a 3RT1946-4EA1 cover is needed to comply with the phase clearance.

3) When connecting conductors which are larger than 25 mm², the 3RT1946-4EA1 cover must be used to keep the phase clearance.

4) "Technical Specifications" for 3RV16 voltage transformer circuit breakers, see page 7/60.

5) If two different conductor cross-sections are connected to one clamping point, both cross-sections must be in the range specified.

Rated data of the auxiliary switches and signaling switches					
Type 3RV19		Lateral auxiliary switch with 1 NO + 1 NC, 2 NO, 2 NC, 2 NO + 2 NC; Signaling switches	Transverse auxiliary switches with 1 CO	1 NO + 1 NC, 2 NO	
Max. Rated voltage					
• Acc. to NEMA (UL)	V AC	600			250
• Acc. to NEMA (CSA)	V AC	600			250
Uninterrupted current	A	10	5		2.5
Switching capacity		A600 Q300	B600 R300		C300 R300

Motor Starter Protectors/Circuit Breakers

SIRIUS 3RV1 Motor Starter Protectors/Circuit Breakers up to 100 A

General data

Voltage transformer circuit breakers

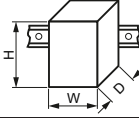
General data			3RV1611-1AG14	3RV1611-1CG14	3RV1611-1DG14
Type			S00	S00	S00
Size					
Dimensions (W x H x D)		mm	45 x 90 x 70	45 x 90 x 70	45 x 90 x 70
Rated current I_n		A	1.4	2.5	3
Ambient temperature					
• During storage/transport		°C	-50 ... +80		
• During operation		°C	-20 ... +60 (up to +70°C is possible with current reduction)		
Rated operational voltage U_e		V	400		
Rated frequency		Hz	16.66 ... 60		
Rated insulation voltage U_i		V	690		
Short-circuit breaking capacity I_{cu} at 400 V AC		kA	50		
Set value of the thermal overload release		A	1.4	2.5	3
Response value of the instantaneous overcurrent release		A	6 ± 20 %	10.5 ± 20 %	20 ± 20 %
Tripping time of the instantaneous overcurrent release		ms	Approx. 6 at 12 A	Approx. 6 at 20 A	Approx. 6 at 40 A
Internal resistance					
• In cold state		Ω	> 0.25 ± 6.5 %		
• In heated state		Ω	> 0.30 ± 6.5 %		
Shock resistance acc. to IEC 60068-2-27		g/ms	15		
Degree of protection acc. to IEC 60529			IP20		
Touch protection acc. to EN 50274			Finger-safe for vertical contact from the front		
Endurance					
• Mechanical	Operating cycles		10 000		
• Electrical	Operating cycles		10 000		
Permissible mounting position			Any		

Type		3RV1611-1AG14	3RV1611-1CG14	3RV1611-1DG14
Conductor cross-sections, main circuit, 1 or 2 conductors				
Connection type		 Screw terminals		
Terminal screw		Pozidriv size 2		
Conductor cross-sections (min./max.), 1 or 2 conductors can be connected				
• Solid or stranded	mm ²	2 x (0.5 ... 1.5) ¹⁾ , 2 x (0.75 ... 2.5) ¹⁾ , max. 4		
• Finely stranded with end sleeve (DIN 46228-1)	mm ²	2 x (0.5 ... 1.5) ¹⁾ , 2 x (0.75 ... 2.5) ¹⁾		
Auxiliary switches for blocking the distance protection				
With defined lateral assignment for blocking distance protection		1 CO (for use as 1 NO or 1 NC)		
Rated operational voltage U_e	Alternating voltage	V	125	
Rated operational current I_e/AC-14	at $U_e = 125$ V	A	0.1	
Rated operational voltage U_e	Direct voltage L/R 200 ms	V	60	
Rated operational current I_e/DC-13	at $U_e = 60$ V	A	0.3	
Minimum load capacity		V	5	
		mA	1	
Short-circuit protection for auxiliary circuit				
Melting fuses operational class gG		A	10	
Miniature circuit breakers C characteristic		A	6 (prospective short-circuit current < 0.4 kA)	
Auxiliary switches for other signaling purposes				

For technical specifications, see the next page.

¹⁾ If two different conductor cross-sections are connected to one clamping point, both cross-sections must be in the range specified.

Motor Starter Protectors/Circuit Breakers

SIRIUS 3RV1 Motor Starter Protectors/Circuit Breakers up to 100 A

General data

Mountable accessories

Front transverse auxiliary switches		Switching capacity for different voltages	
		1 CO	1 NO + 1 NC, 2 NO
Rated operational current I_e			
• At AC-15, alternating voltage	- 24 V	A	4
	- 230 V	A	3
• At AC-12 = I_{th} , alternating voltage	- 24 V	A	10
	- 230 V	A	10
• At DC-13, direct voltage L/R 200 ms	- 24 V	A	1
	- 48 V	A	--
	- 60 V	A	--
	- 110 V	A	0.22
	- 220 V	A	0.1
Minimum load capacity		V	17
		mA	1

Front transverse solid-state compatible auxiliary switches		Switching capacity for different voltages	
		1 CO	
Rated operational voltage U_e	Alternating voltage	V	125
Rated operational current $I_e/AC-14$	at $U_e = 125$ V	A	0.1
Rated operational voltage U_e	Direct voltage L/R 200 ms	V	60
Rated operational current $I_e/DC-13$	at $U_e = 60$ V	A	0.3
Minimum load capacity		V	5
		mA	1



Lateral auxiliary switches with signaling switch		Switching capacity for different voltages:	
		Lateral auxiliary switch with 1 NO + 1 NC, 2 NO, 2 NC, 2 NO + 2 NC Signaling switch	
Rated operational current I_e			
• At AC-15, alternating voltage	- 24 V	A	6
	- 230 V	A	4
	- 400 V	A	3
	- 690 V	A	1
• At AC-12 = I_{th} , alternating voltage	- 24 V	A	10
	- 230 V	A	10
	- 400 V	A	10
	- 690 V	A	10
• At DC, direct voltage L/R 200 ms	- 24 V	A	2
	- 110 V	A	0.5
	- 220 V	A	0.25
	- 440 V	A	0.1
Minimum load capacity		V	17
		mA	1

Auxiliary releases		Undervoltage releases		Shunt releases	
Power consumption					
• During pick-up	- AC voltages	VA/W	20.2/13		20.2/13
	- DC voltages	W	20		13 ... 80
• During uninterrupted duty	- AC voltages	VA/W	7.2/2.4		--
	- DC voltages	W	2.1		--
Response voltage					
• Tripping		V	0.35 ... 0.7 x U_s		0.7 ... 1.1 x U_s
• Pick-up		V	0.85 ... 1.1 x U_s		--
Opening time maximum		ms	20		

Motor Starter Protectors/Circuit Breakers

SIRIUS 3RV1 Motor Starter Protectors/Circuit Breakers up to 100 A

General data

Short-circuit protection for auxiliary and control circuits		
Melting fuses operational class gG	A	10
Miniature circuit breakers C characteristic	A	6 (prospective short-circuit current < 0.4 kA)
Conductor cross-sections for auxiliary and control circuits		
Connection type	 Screw terminals	
Terminal screw	Pozidriv size 2	
Prescribed tightening torque	Nm	0.8 ... 1.2
Conductor cross-sections (min./max.) , 1 or 2 conductors can be connected		
• Solid or stranded	mm ²	2 x (0.5 ... 1.5) ¹⁾ / 2 x (0.75 ... 2.5) ¹⁾
• Finely stranded with end sleeve (DIN 46228-1)	mm ²	2 x (0.5 ... 1.5) ¹⁾ / 2 x (0.75 ... 2.5) ¹⁾
• AWG cables	AWG	2 x (18 ... 14)
Connection type	 Spring-type terminals²⁾³⁾	
Conductor cross-sections (min./max.) , 1 or 2 conductors can be connected		
• Solid or stranded	mm ²	2 x (0.25 ... 2.5)
• Finely stranded with end sleeve (DIN 46228-1)	mm ²	2 x (0.25 ... 1.5)
• Finely stranded without end sleeve	mm ²	2 x (0.25 ... 2.5)
• AWG cables, solid or stranded	AWG	2 x (24 ... 14)
Max. external diameter of the conductor insulation	mm	3.6
<p>¹⁾ If two different conductor cross-sections are connected to one clamping point, both cross-sections must be in the range specified.</p> <p>²⁾ With conductor cross-sections ≤ 1 mm², an "insulation stop" must be used; see Chapter 3 "Controls – Contactors and Contactor Assemblies". → "Accessories".</p> <p>³⁾ Corresponding opening tool 3RA2908-1A, see "Accessories", page 7/76.</p>		

Motor Starter Protectors/Circuit Breakers

SIRIUS 3RV1 Motor Starter Protectors up to 100 A

For motor protection

Selection and ordering data

CLASS 10, without auxiliary switches

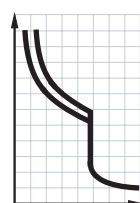

Rated current	Suitable for three-phase motors ¹⁾ with P	Setting range for thermal overload release	Instantaneous overcurrent releases	Short-circuit breaking capacity at 400 V AC	DT	Screw terminals	⊕	PU (UNIT, SET, M)	PS*	PG
I_n			$I >$	I_{cu}		Article No.	Price per PU			
A	kW	A	A	kA						

Size S3



3RV1041-4LA10

40	18.5	28 ... 40	520	50	▶	3RV1041-4FA10		1	1 unit	41E
50	22	36 ... 50	650	50	▶	3RV1041-4HA10		1	1 unit	41E
63	30	45 ... 63	819	50	▶	3RV1041-4JA10		1	1 unit	41E
75 ²⁾	37	57 ... 75	975	50	▶	3RV1041-4KA10		1	1 unit	41E
90 ²⁾	45	70 ... 90	1 170	50	▶	3RV1041-4LA10		1	1 unit	41E
100 ²⁾	45	80 ... 100	1 235	50	▶	3RV1041-4MA10		1	1 unit	41E

Size S3, with increased switching capacity



3RV1042-4JA10

16	7.5	11 ... 16	208	100	▶	3RV1042-4AA10		1	1 unit	41E
20	7.5	14 ... 20	260	100	▶	3RV1042-4BA10		1	1 unit	41E
25	11	18 ... 25	325	100	▶	3RV1042-4DA10		1	1 unit	41E
32	15	22 ... 32	416	100	▶	3RV1042-4EA10		1	1 unit	41E
40	18.5	28 ... 40	520	100	▶	3RV1042-4FA10		1	1 unit	41E
50	22	36 ... 50	650	100	▶	3RV1042-4HA10		1	1 unit	41E
63	30	45 ... 63	819	100	▶	3RV1042-4JA10		1	1 unit	41E
75 ²⁾	37	57 ... 75	975	100	▶	3RV1042-4KA10		1	1 unit	41E
90 ²⁾	45	70 ... 90	1 170	100	▶	3RV1042-4LA10		1	1 unit	41E
100 ²⁾	45	80 ... 100	1 235	100	▶	3RV1042-4MA10		1	1 unit	41E

CLASS 20, without auxiliary switches

Size S3, with increased switching capacity



3RV1042-4KB10

40	18.5	28 ... 40	520	100	A	3RV1042-4FB10		1	1 unit	41E
50	22	36 ... 50	650	100	A	3RV1042-4HB10		1	1 unit	41E
63	30	45 ... 63	819	100	A	3RV1042-4JB10		1	1 unit	41E
75 ²⁾	37	57 ... 75	975	100	A	3RV1042-4KB10		1	1 unit	41E
90 ²⁾	45	70 ... 90	1 170	100	A	3RV1042-4LB10		1	1 unit	41E
100 ²⁾	45	80 ... 100	1 235	100	A	3RV1042-4MB10		1	1 unit	41E

¹⁾ Guide value for 4-pole standard motors at 50 Hz 400 V AC. The actual starting and rated data of the motor to be protected must be considered when selecting the units.

²⁾ For the use of 3RV104. motor starter protectors with an energy-efficient IE3 motor we recommend using a contactor for normal switching duty, see also page 7/53.

Auxiliary switches and other accessories can be ordered separately (see "Accessories" page 7/70 onwards).

Multi-unit/reusable packaging available on request.

Motor Starter Protectors/Circuit Breakers

SIRIUS 3RV1 Motor Starter Protectors up to 100 A

For motor protection with overload relay function

Selection and ordering data

CLASS 10, with overload relay function (automatic RESET), without auxiliary switches

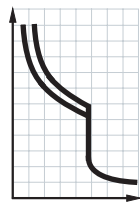

Rated current	Suitable for three-phase motors ¹⁾ with P	Setting range for thermal overload release	Instantaneous overcurrent release	Short-circuit breaking capacity at 400 V AC	DT	Screw terminals	⊕	PU (UNIT, SET, M)	PS*	PG
I_n				I_{cu}		Article No.	Price per PU			
A	kW	A	A	kA						

Size S3, with increased switching capacity²⁾



16	7.5	11 ... 16	208	100	A	3RV1142-4AA10		1	1 unit	41E
20	7.5	14 ... 20	260	100	A	3RV1142-4BA10		1	1 unit	41E
25	11	18 ... 25	325	100	A	3RV1142-4DA10		1	1 unit	41E
32	15	22 ... 32	416	100	A	3RV1142-4EA10		1	1 unit	41E
40	18.5	28 ... 40	520	100	A	3RV1142-4FA10		1	1 unit	41E
50	22	36 ... 50	650	100	A	3RV1142-4HA10		1	1 unit	41E
63	30	45 ... 63	819	100	A	3RV1142-4JA10		1	1 unit	41E
75 ³⁾	37	57 ... 75	975	100	A	3RV1142-4KA10		1	1 unit	41E
90 ³⁾	45	70 ... 90	1 170	100	A	3RV1142-4LA10		1	1 unit	41E
100 ³⁾	45	80 ... 100	1 235	100	A	3RV1142-4MA10		1	1 unit	41E

1) Guide value for 4-pole standard motors at 50 Hz 400 V AC. The actual starting and rated data of the motor to be protected must be considered when selecting the units.

2) Accessories (auxiliary releases) for mounting on the right cannot be used.

3) For the use of 3RV1142 motor starter protectors with an energy-efficient IE3 motor we recommend using a contactor for normal switching duty, see also page 7/53.

Auxiliary switches and other accessories can be ordered separately (see "Accessories" page 7/70 onwards).

Motor Starter Protectors/Circuit Breakers

SIRIUS 3RV1 Motor Starter Protectors up to 100 A

For starter combinations

Selection and ordering data

Without auxiliary switches

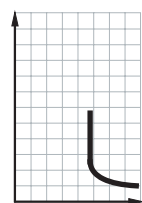

Rated current	Suitable for three-phase motors ¹⁾ with P	Thermal overload release ²⁾	Instantaneous overcurrent releases	Short-circuit breaking capacity at 400 V AC	DT	Screw terminals	⊕	PU (UNIT, SET, M)	PS*	PG
I_n				I_{cu}		Article No.	Price per PU			
A	kW	A	A	kA						

Size S3



3RV1341-4JC10

40	18.5	Without	520	50	A	3RV1341-4FC10		1	1 unit	41E
50	22	Without	650	50	A	3RV1341-4HC10		1	1 unit	41E
63	30	Without	819	50	A	3RV1341-4JC10		1	1 unit	41E
75 ³⁾	37	Without	975	50	A	3RV1341-4KC10		1	1 unit	41E
90 ³⁾	45	Without	1 170	50	A	3RV1341-4LC10		1	1 unit	41E
100 ³⁾	45	Without	1 235	50	A	3RV1341-4MC10		1	1 unit	41E

Size S3, with increased switching capacity



3RV1342-4JC10

16	7.5	Without	208	100	A	3RV1342-4AC10		1	1 unit	41E
20	7.5	Without	260	100	A	3RV1342-4BC10		1	1 unit	41E
25	11	Without	325	100	A	3RV1342-4DC10		1	1 unit	41E
32	15	Without	416	100	A	3RV1342-4EC10		1	1 unit	41E
40	18.5	Without	520	100	A	3RV1342-4FC10		1	1 unit	41E
50	22	Without	650	100	A	3RV1342-4HC10		1	1 unit	41E
63	30	Without	819	100	A	3RV1342-4JC10		1	1 unit	41E
75 ³⁾	37	Without	975	100	A	3RV1342-4KC10		1	1 unit	41E
90 ³⁾	45	Without	1 170	100	A	3RV1342-4LC10		1	1 unit	41E
100 ³⁾	45	Without	1 235	100	A	3RV1342-4MC10		1	1 unit	41E

1) Guide value for 4-pole standard motors at 50 Hz 400 V AC. The actual starting and rated data of the motor to be protected must be considered when selecting the units.

2) For overload protection of the motors, appropriate overload relays must be used.

3) For the use of 3RV134. motor starter protectors with an energy-efficient IE3 motor we recommend using a contactor for normal switching duty, see also page 7/53.

Auxiliary switches and other accessories can be ordered separately (see "Accessories" page 7/70 onwards).

Multi-unit/reusable packaging available on request.



Motor Starter Protectors/Circuit Breakers

SIRIUS 3RV1 Motor Starter Protectors up to 100 A

For fuse monitoring

Selection and ordering data

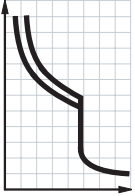
Without auxiliary switches

	Rated current	Thermal overload releases	Instantaneous overcurrent release	Short-circuit breaking capacity at 400 V AC	DT	Screw terminals	PU (UNIT, SET, M)	PS*	PG
	I_n			I_{cu}		Article No.	Price per PU		
	A	A	A	kA					

Size S00



3RV1611-0BD10

0.2	0.2	1.2	100	▶	3RV1611-0BD10		1	1 unit	41E
-----	-----	-----	-----	---	----------------------	--	---	--------	-----

Note:

The auxiliary switch required for signaling must be ordered separately.

Multi-unit/reusable packaging available on request.

Accessories

Version	Contacts	DT	Screw terminals	PU (UNIT, SET, M)	PS*	PG
			Article No.	Price per PU		

Mountable auxiliary switches (essential accessories)



3RV1901-1E

Transverse auxiliary switches With screw terminals, mountable on front	1 NO + 1 NC	▶	3RV1901-1E		1	1 unit	41E
--	-------------	---	-------------------	--	---	--------	-----



3RV1901-1A

Lateral auxiliary switches With screw terminals, mountable on the left	1 NO + 1 NC	▶	3RV1901-1A		1	1 unit	41E
--	-------------	---	-------------------	--	---	--------	-----

Additional auxiliary switches and other accessories, see "Accessories" page 7/70 onwards.

Motor Starter Protectors/Circuit Breakers





SIRIUS 3RV1 Circuit Breakers up to 100 A

For system protection according to UL 489/CSA C22.2 No. 5

Selection and ordering data

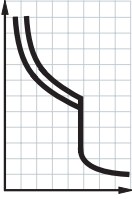
Without auxiliary switches

Circuit breakers for system protection and non-motor loads according to UL/CSA

	Rated current ¹⁾	Thermal overload releases (non-adjustable)	Instantaneous overcurrent release	Short-circuit breaking capacity at 480 Y/277 V AC ²⁾		DT	Screw terminals	⊕	PU (UNIT, SET, M)	PS*	PG
	$I_n^{1)}$			I_{bc}	I_{bc}		Article No.				
	A	A	A	kA	kA						
Size S3											
	10	10	150	65	65	B	3RV1742-5AD10		1	1 unit	41E
	15	15	225	65	65	B	3RV1742-5BD10		1	1 unit	41E
	20	20	260	65	65	B	3RV1742-5CD10		1	1 unit	41E
	25	25	325	65	65	B	3RV1742-5DD10		1	1 unit	41E
	30	30	390	65	65	B	3RV1742-5ED10		1	1 unit	41E
	35	35	455	65	--	B	3RV1742-5FD10		1	1 unit	41E
	40	40	520	65	--	B	3RV1742-5GD10		1	1 unit	41E
	45	45	585	65	--	B	3RV1742-5HD10		1	1 unit	41E
	50	50	650	65	--	B	3RV1742-5JD10		1	1 unit	41E
	60	60	780	65	--	B	3RV1742-5LD10		1	1 unit	41E
70	70	910	65	--	B	3RV1742-5QD10		1	1 unit	41E	

¹⁾ Rated value 100 % according to UL 489 and IEC 60947-2 ("100 % rated breaker").

²⁾ Values for 600 Y/347 V AC, see page 7/57.

Transverse auxiliary switches must not be mounted, lateral auxiliary switches can be ordered separately (see "Accessories" page 7/70 onwards).



Motor Starter Protectors/Circuit Breakers

SIRIUS 3RV1 Motor Starter Protectors up to 100 A

For distance protection

Selection and ordering data

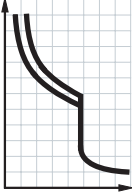
Voltage transformer motor starter protectors with auxiliary switches (1 CO)

	Rated current	Thermal overload releases	Instantaneous overcurrent release	Auxiliary switch integrated in the motor starter protector, transverse	Short-circuit breaking capacity at 400 V AC	DT	Screw terminals	PU (UNIT, SET, M)	PS*	PG
	I_n		$I >$		I_{cu}		Article No.	Price per PU		
	A	A	A		kA					
Size S00										
 3RV1611-1.G14	1.4	1.4	6	1 CO	50	B	3RV1611-1AG14 3RV1611-1CG14 3RV1611-1DG14	1	1 unit	41E
	2.5	2.5	10.5	1 CO	50	▶		1	1 unit	41E
	3	3	20	1 CO	50	▶		1	1 unit	41E

Accessories

Version	Contacts	DT	Screw terminals	PU (UNIT, SET, M)	PS*	PG
			Article No.	Price per PU		
Mountable auxiliary switches for other signaling purposes						
 3RV1901-1A	Lateral auxiliary switches With screw terminals, mountable on the left	1 NO + 1 NC	▶ 3RV1901-1A	1	1 unit	41E

Additional auxiliary switches and other accessories, see "Accessories" page 7/70 onwards.

Motor Starter Protectors/Circuit Breakers

SIRIUS 3RV1 Motor Starter Protectors/Circuit Breakers up to 100 A Accessories

Mountable accessories

Overview

Mounting location and function

The 3RV1 motor starter protectors/circuit breakers have three main contact elements. In order to achieve maximum flexibility, auxiliary switches, signaling switches, auxiliary releases and isolator modules can be supplied separately.

These components are easily fitted to the switches without the use of any tools according to requirements.

Overview graphic, [see page 7/51](#).

<p>Front side</p> <p><u>Notes:</u></p> <ul style="list-style-type: none"> • A maximum of four auxiliary contacts with auxiliary switches can be mounted on each motor starter protector. • Transverse auxiliary switches must not be used for the 3RV1742 circuit breakers. 	<p>Transverse auxiliary switches, solid-state compatible transverse auxiliary switches</p> <p>1 NO + 1 NC or 2 NO or 1 CO</p>	<p>An auxiliary switch block can be inserted transversely on the front. The overall width of the motor starter protectors remains unchanged.</p>
<p>Left-hand side</p> <p><u>Notes:</u></p> <ul style="list-style-type: none"> • A maximum of four auxiliary contacts with auxiliary switches can be mounted on each motor starter protector/circuit breaker. • Lateral auxiliary switches (two contacts) and signaling switches can be mounted separately or together. • The signaling switch cannot be used for the 3RV1742 circuit breakers. 	<p>Lateral auxiliary switches (2 contacts)</p> <p>1 NO + 1 NC or 2 NO or 2 NC</p> <p>Lateral auxiliary switches (4 contacts)</p> <p>2 NO + 2 NC</p>	<p>One of the three lateral auxiliary switches can be mounted on the left side per motor starter protector/circuit breaker. The contacts of the auxiliary switch close and open together with the main contacts of the motor starter protector/circuit breaker.</p> <p>The width of the lateral auxiliary switch with two contacts is 9 mm.</p> <p>One lateral auxiliary switch with four contacts can be mounted on the left side per motor starter protector/circuit breaker. The contacts of the auxiliary switch close and open together with the main contacts of the motor starter protector/circuit breaker.</p> <p>The width of the lateral auxiliary switch with four contacts is 18 mm.</p>
	<p>Signaling switches</p> <p>Tripping 1 NO + 1 NC Short circuit 1 NO + 1 NC</p>	<p>One signaling switch can be mounted on the left side of each motor starter protector.</p> <p>The signaling switch has two contact systems.</p> <p>One contact system always signals <u>tripping</u> irrespective of whether this was caused by a short circuit, an overload or an auxiliary release. The other contact system only switches in the event of a short circuit. There is no signaling as a result of <u>switching off</u> with the actuator.</p> <p>In order to be able to switch on the motor starter protector again after a short circuit, the signaling switch must be reset manually after the error cause has been eliminated.</p> <p>The overall width of the signaling switch is 18 mm.</p>
<p>Right-hand side</p> <p><u>Notes:</u></p> <ul style="list-style-type: none"> • One auxiliary release can be mounted per motor starter protector/circuit breaker. • Accessories cannot be mounted at the right-hand side of the 3RV11 motor starter protectors for motor protection with overload relay function. 	<p>Auxiliary releases</p> <p>Shunt releases</p> <p>or</p> <p>Undervoltage releases</p> <p>or</p> <p>Undervoltage releases with leading auxiliary contacts 2 NO</p>	<p>For remote-controlled tripping of the motor starter protector/circuit breaker. The release coil should only be energized for short periods (see circuit diagrams).</p> <p>Trips the motor starter protector/circuit breaker when the voltage is interrupted and prevents the motor from being restarted accidentally when the voltage is restored. Used for remote-controlled tripping of the motor starter protector/circuit breaker.</p> <p>Particularly suitable for EMERGENCY-STOP disconnection by way of corresponding EMERGENCY-STOP pushbuttons according to DIN EN 60204-1.</p> <p>Function and use as for the undervoltage release without leading auxiliary contacts, but with the following additional function: the auxiliary contacts will open in switch position OFF to deenergize the coil of the undervoltage release, thus interrupting energy consumption. In the "tripped" position, these auxiliary contacts are not guaranteed to open. The leading contacts permit the motor starter protector/circuit breaker to reclose.</p> <p>The overall width of the auxiliary release is 18 mm.</p>









For a complete overview of which accessories can be used for the various motor starter protectors, [see page 7/3](#).

Motor Starter Protectors/Circuit Breakers





SIRIUS 3RV1 Motor Starter Protectors/Circuit Breakers up to 100 A Accessories

Mountable accessories

Selection and ordering data

Version	Contacts	For motor starter protectors/ circuit breakers	DT	Screw terminals 	PU (UNIT, SET, M)	PS*	PG	
Size				Article No.	Price per PU			
Auxiliary switches¹⁾								
 3RV1901-1E	Transverse auxiliary switches With screw terminals, mountable on front	1 CO 1 NO + 1 NC 2 NO	S00, S3	▶ ▶ ▶	3RV1901-1D 3RV1901-1E 3RV1901-1F	1 1 1	1 unit 1 unit 1 unit	41E 41E 41E
 3RV1901-1G	Electronic compatible transverse auxiliary switches With screw terminals, front mountable, for operation in dusty atmosphere and in solid-state circuits with low operating currents	1 CO	S00, S3	A	3RV1901-1G	1	1 unit	41E
 3RV1901-0H	Covers for transverse auxiliary switches	--	S00, S3	▶	3RV1901-0H	1	10 units	41E
 3RV1901-1A	Lateral auxiliary switches With screw terminals, mountable on the left	1 NO + 1 NC	S00, S3	▶	3RV1901-1A	1	1 unit	41E
 3RV1901-1B		2 NO		▶	3RV1901-1B	1	1 unit	41E
 3RV1901-1C		2 NC		▶	3RV1901-1C	1	1 unit	41E
 3RV1901-1J		2 NO + 2 NC		A	3RV1901-1J	1	1 unit	41E

¹⁾ Each motor starter protector can be fitted with one transverse and one lateral auxiliary switch. The lateral auxiliary switch with 2 NO + 2 NC is used without a transverse auxiliary switch. Transverse auxiliary switches must not be used for the 3RV1742 circuit breakers.

Version	Contacts	For motor starter protectors/ circuit breakers	DT	Spring-type terminals 	PU (UNIT, SET, M)	PS*	PG	
Size				Article No.	Price per PU			
Auxiliary switches¹⁾								
 3RV1901-2E	Transverse auxiliary switches With spring-type terminals, mountable on the front	1 NO + 1 NC 2 NO	S00, S3	▶ ▶	3RV1901-2E 3RV1901-2F	1 1	1 unit 1 unit	41E 41E
 3RV1901-2A	Lateral auxiliary switches With spring-type terminals, mountable on the left	1 NO + 1 NC	S00, S3	▶	3RV1901-2A	1	1 unit	41E
 3RV1901-2B		2 NO		▶	3RV1901-2B	1	1 unit	41E
 3RV1901-2C		2 NC		▶	3RV1901-2C	1	1 unit	41E

¹⁾ Each motor starter protector can be fitted with one transverse and one lateral auxiliary switch. Transverse auxiliary switches must not be used for the 3RV1742 circuit breakers.

Motor Starter Protectors/Circuit Breakers

SIRIUS 3RV1 Motor Starter Protectors/Circuit Breakers up to 100 A

Accessories

Mountable accessories

Version	For motor starter protectors	DT	Screw terminals	PU (UNIT, SET, M)	PS*	PG
			Article No.	Price per PU		

Signaling switches¹⁾



3RV1921-1M

Signaling switches	Separate tripped and short-circuit alarms, 1 NO + 1 NC each	S3	▶	3RV1921-1M	1	1 unit	41E
One signaling switch can be mounted on the left per motor starter protector.							

¹⁾ This accessory cannot be used for the 3RV1742 circuit breakers.

Rated control supply voltage U_s					For motor starter protectors/circuit breakers	DT	Screw terminals	PU (UNIT, SET, M)	PS*	PG
AC 50 Hz	AC 60 Hz	AC 50/60 Hz	AC/DC 50/60 Hz, DC 5 s ON period ²⁾	DC			Article No.	Price per PU		
V	V	V	V	V	Size					

Auxiliary releases³⁾



3RV1902-1DP0

Undervoltage releases										
--	--	--	--	24	S3	A	3RV1902-1AB4	1	1 unit	41E
24	--	--	--	--	S3	A	3RV1902-1AB0	1	1 unit	41E
110	120	--	--	--	S3	A	3RV1902-1AF0	1	1 unit	41E
--	208	--	--	--	S3	A	3RV1902-1AM1	1	1 unit	41E
230	240	--	--	--	S3	▶	3RV1902-1AP0	1	1 unit	41E
400	440	--	--	--	S3	▶	3RV1902-1AV0	1	1 unit	41E
415	480	--	--	--	S3	A	3RV1902-1AV1	1	1 unit	41E
500	600	--	--	--	S3	A	3RV1902-1AS0	1	1 unit	41E
Undervoltage releases with leading auxiliary contacts 2 NO										
230	240	--	--	--	S3	A	3RV1922-1CP0	1	1 unit	41E
400	440	--	--	--	S3	A	3RV1922-1CV0	1	1 unit	41E
415	480	--	--	--	S3	A	3RV1922-1CV1	1	1 unit	41E
Shunt releases										
--	--	20 ... 24	20 ... 70	--	S3	▶	3RV1902-1DB0	1	1 unit	41E
--	--	90 ... 110	70 ... 190	--	S3	A	3RV1902-1DF0	1	1 unit	41E
--	--	210 ... 240	190 ... 330	--	S3	▶	3RV1902-1DP0	1	1 unit	41E
--	--	350 ... 415	330 ... 500	--	S3	A	3RV1902-1DV0	1	1 unit	41E
--	--	500	500	--	S3	A	3RV1902-1DS0	1	1 unit	41E

¹⁾ The voltage range is valid for 100 % (infinite) ON period. The response voltage lies at 0.9 of the lower limit of the voltage range.

²⁾ The voltage range is valid for 5 s ON period at AC 50/60Hz and DC. The response voltage lies at 0.85 of the lower limit of the voltage range.

³⁾ One auxiliary release can be mounted on the right per motor starter protector (does not apply to 3RV11 motor starter protectors with overload relay function).

Motor Starter Protectors/Circuit Breakers

SIRIUS 3RV1 Motor Starter Protectors/Circuit Breakers up to 100 A Accessories

Busbar accessories

Overview

8US busbar adapters for 40 mm and 60 mm systems

The motor starter protectors/circuit breakers are mounted directly with the aid of busbar adapters on busbar systems with 40 mm and 60 mm center-to-center clearance in order to save space and to reduce infeed times and costs. Busbar adapters for busbar systems with 40 mm center-to-center clearance are suitable for copper busbars with a width of 12 mm to 15 mm, while those with 60 mm center-to-center clearance are suitable for copper busbars with a width of 12 mm to 30 mm. The busbars can be 4 to 5 mm or 10 mm thick.

The motor starter protectors/circuit breakers are snapped onto the adapter and connected on the line side. This prepared unit is then plugged directly onto the busbar system, and is thus connected both mechanically and electrically at the same time.

For further busbar adapters for snap-mounting direct-on-line starters and reversing starters as well as additional accessories such as line terminals and outgoing terminals, flat copper profile, etc., see Catalog LV 10 "Low-Voltage Power Distribution and Electrical Installation Technology".



SIRIUS load feeders with busbar adapters snapped onto busbars

Selection and ordering data

8US busbar adapters



8US1111-4SM00



8US1211-4TR00

For motor starter protectors	Rated current	Connecting cable	Adapter length	Adapter width	Rated voltage	DT	Article No.	Price per PU	PU (UNIT, SET, M)	PS*	PG
Size	A	AWG	mm	mm	V						
Busbar adapters for 40 mm systems											
For flat copper profiles according to DIN 46433 Width: 12 mm and 15 mm Thickness: 5 mm and 10 mm											
S3	100	4	182	70	400 ¹⁾	▶	8US1111-4SM00		1	1 unit	140
S3	100	4	182	72	415 ... 690 ²⁾	▶	8US1011-4TM00		1	1 unit	140
Busbar adapters for 60 mm systems											
For flat copper profiles according to DIN 46433 Width: 12 mm and 30 mm Thickness: 5 mm and 10 mm also for T and double-T special profiles											
S3	100	4	182	70	400 ¹⁾	▶	8US1111-4SM00		1	1 unit	140
S3	100	4	182	72	415 ... 690 ²⁾	A	8US1211-4TM00		1	1 unit	140
S3 ³⁾	70 ⁴⁾	4	215	72	600 ⁴⁾	A	8US1211-4TR00		1	1 unit	140

1) At rated voltage
≤ 400 V: short-circuit breaking capacity 50 kA,
> 400 to 460 V: short-circuit breaking capacity 25 kA.

2) Short-circuit breaking capacity 415/500/525 V AC:
- Up to $I_n = 25$ A: max. 30 kA
- Up to $I_n = 90$ A: max. 16 kA
- Up to $I_n = 100$ A: max. 6 kA
Short-circuit breaking capacity 690 V AC:
- Max. 12 kA.

3) This busbar adapter is approved specially for 3RV1742 circuit breakers for applications according to UL/CSA.

4) Values according to UL/CSA
- Rated current: 70 A at 600 V AC;
- Short-circuit breaking capacity:
480 V AC: 65 kA, up to $I_n = 30$ A;
480 Y/277 V AC: 65 kA,
600 Y/347 V AC: 20 kA.

For additional busbar adapters, see Catalog LV 10 "Low-Voltage Power Distribution and Electrical Installation Technology".

Motor Starter Protectors/Circuit Breakers

SIRIUS 3RV1 Motor Starter Protectors/Circuit Breakers up to 100 A

Accessories

Rotary operating mechanisms

Overview

Door-coupling rotary operating mechanisms

Motor starter protectors/circuit breakers with a rotary operating mechanism can be mounted in a control cabinet and operated externally by means of a door-coupling rotary operating mechanism. When the cabinet door with motor starter protector/circuit breaker is closed, the operating mechanism is coupled. When the motor starter protector/circuit breaker closes, the coupling is locked which prevents the door from being opened unintentionally. This interlock can be defeated by the maintenance personnel. In the OPEN position, the rotary operating mechanism can be secured against reclosing with up to three padlocks. Inadvertent opening of the door is not possible in this case either.

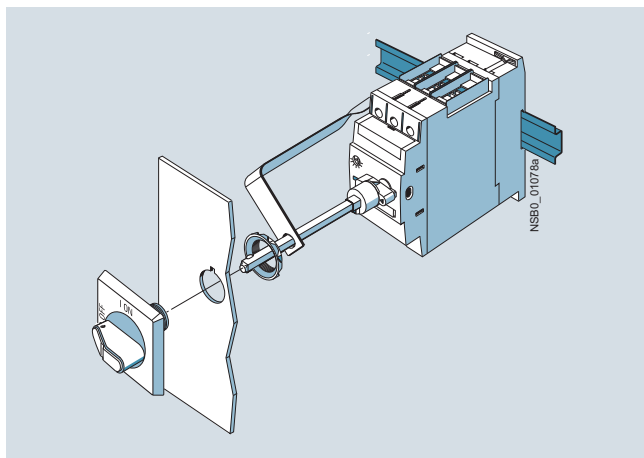

SIRIUS 3RV1926-0K door-coupling rotary operating mechanism

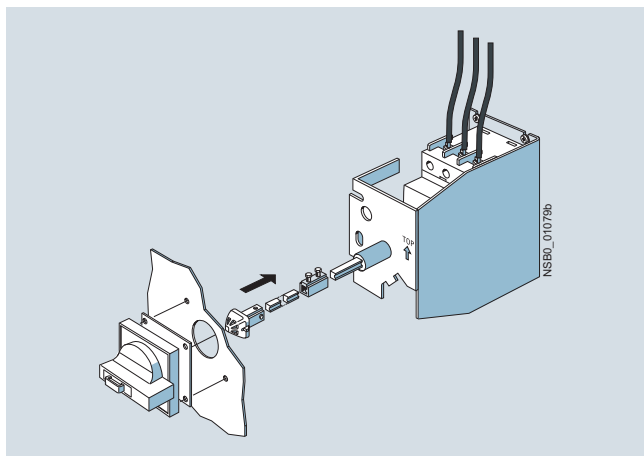

SIRIUS 3RV2946-2B door-coupling rotary operating mechanism for arduous conditions

Remote motorized operating mechanisms

3RV1 motor starter protectors/circuit breakers are manually operated controls. They automatically trip in case of an overload or short circuit. Intentional remote-controlled tripping is possible by means of a shunt release or an undervoltage release. Reclosing is only possible directly at the motor starter protector/circuit breaker.

The remote motorized operating mechanism allows the motor starter protectors/circuit breakers to be opened and closed by electrical commands. This enables a load or an installation to be isolated from the network or reconnected to it from an operator panel.

If the motor starter protector/circuit breaker is tripped as a result of overload or short circuit, it will be in tripped position. For reclosing, the remote motorized operating mechanism must first be set manually or electrically to the 0 position (electrically by means of the Open command). Then it can be reclosed.

The remote motorized operating mechanism is available for motor starter protectors/circuit breakers in size S3 for control voltages of 230 V AC and 24 V DC. The motor starter protector/circuit breaker is fitted into the remote motorized operating mechanism as shown in the drawing.

In the "MANUAL" position, the motor starter protector/circuit breaker in the remote motorized operating mechanism can continue to be switched manually on site. In the "AUTOMATIC" position, the motor starter protector/circuit breaker is switched by means of electrical commands. The switching command must be applied for a minimum of 100 ms. The remote motorized operating mechanism closes the motor starter protector/circuit breaker after a maximum of 1 s. On voltage failure during the switching operation it is ensured that the motor starter protector/circuit breaker remains in the "OPEN" or "CLOSED" position. In the "MANUAL" and "OFF" position, the remote motorized operating mechanism can be locked with a padlock.

RESET function

The RESET button on the motorized operating mechanism serves to reset any 3RV1921-1M signaling switch that might be installed.

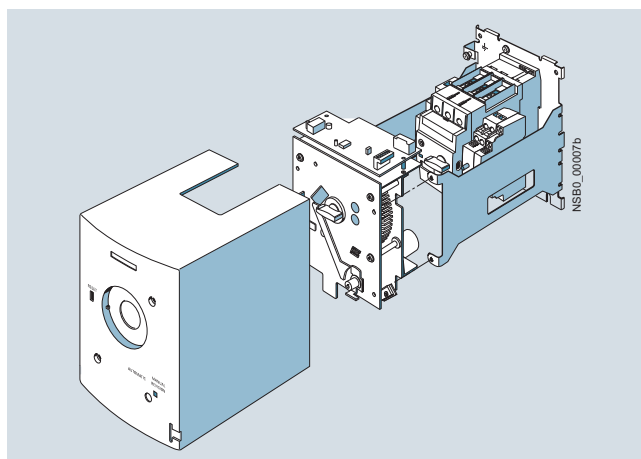

SIRIUS 3RV1946-3A.. remote motorized operating mechanism

Motor Starter Protectors/Circuit Breakers

SIRIUS 3RV1 Motor Starter Protectors/Circuit Breakers up to 100 A Accessories

Rotary operating mechanisms

Technical specifications

Remote motorized operating mechanisms		
Type	3RV1946	
Max. power consumption		
• At $U_s = 24$ V DC	W	48
• At $U_s = 230$ V AC	VA	170
Operating range	0.85 ... 1.1 x U_s	
Minimum command duration at U_s	s	0.1
Max. command duration	Unlimited (uninterrupted operation)	
Max. total break time , remote-controlled	s	2
Ready to reclose after approx.	s	2.5
Switching frequency	1/h	25
Internal back-up fuse		
• 230 V AC	A	0.8
• 24 V DC	A	1.6
Connection type of control cables	Plug-in connectors with screw terminals	
Shock resistance acc. to IEC 60068-2-27	g/ms	25/11 (square and sine pulse)

Selection and ordering data

Version	Color of actuator	Version of extension shaft	For motor starter protectors/circuit breakers	DT	Article No.	Price per PU	PU (UNIT, SET, M)	PS*	PG
		mm	Size						

Door-coupling rotary operating mechanisms



3RV2926-0B

The door-coupling rotary operating mechanisms consist of a knob, a coupling driver and a 130/330 mm long extension shaft (6 mm x 6 mm).

The door-coupling rotary operating mechanisms are designed to degree of protection IP64. The door locking device prevents accidental opening of the control cabinet door in the ON position of the motor starter protector/circuit breaker. The OFF position can be locked with up to 3 padlocks.

Door-coupling rotary operating mechanisms	Black	130 330	S3 S3	▶ ▶	3RV2926-0B 3RV2926-0K		1 1	1 unit 1 unit	41E 41E
EMERGENCY STOP door-coupling rotary operating mechanisms	Red/yellow	130 330	S3 S3	▶ ▶	3RV2926-0C 3RV2926-0L		1 1	1 unit 1 unit	41E 41E

Door-coupling rotary operating mechanisms for arduous conditions



3RV2946-2B

The door-coupling rotary operating mechanisms consist of a knob, a coupling driver, an extension shaft of 300 mm in length (8 mm x 8 mm), a spacer and two metal brackets, into which the motor starter protector/circuit breaker is inserted.

The door-coupling rotary operating mechanisms are designed to degree of protection IP65. The door interlocking reliably prevents opening of the control cabinet door in the ON position of the motor starter protector/circuit breaker. The OFF position can be locked with up to three padlocks.

Laterally mountable auxiliary releases and two-pole auxiliary switches can be used.

The door-coupling rotary operating mechanisms thus meet the requirements for isolating functions according to IEC 60947-2.

Door-coupling rotary operating mechanisms	Gray	300	S3	▶	3RV2946-2B		1	1 unit	41E
EMERGENCY STOP door-coupling rotary operating mechanisms	Red/yellow	300	S3	▶	3RV2946-2C		1	1 unit	41E

Version	Rated control supply voltage U_s	For motor starter protectors/circuit breakers	DT	Article No.	Price per PU	PU (UNIT, SET, M)	PS*	PG
		Size						

Remote motorized operating mechanisms



3RV1946-3A..

Remote motorized operating mechanisms	AC 50/60 Hz, 230 V 24 V DC	S3 S3	X X	3RV1946-3AP0 3RV1946-3AB4		1 1	1 unit 1 unit	41E 41E
--	-------------------------------	----------	--------	--	--	--------	------------------	------------

Motor Starter Protectors/Circuit Breakers

SIRIUS 3RV1 Motor Starter Protectors/Circuit Breakers up to 100 A

Accessories

Mounting accessories

Overview

Terminal blocks for "Self-Protected Combination Motor Controllers (Type E)" according to UL 508/UL 60947-4-1

The 3RV10 motor starter protector/circuit breakers in size S3 are approved according to UL 508/UL 60947-4-1 as "Self-Protected Combination Motor Controllers" (Type E).

This requires increased clearance and creepage distances (1 inch and 2 inches respectively) at the input side of the device, which are achieved by replacing the standard box terminal with the 3RT1946-4GA07 terminal block.

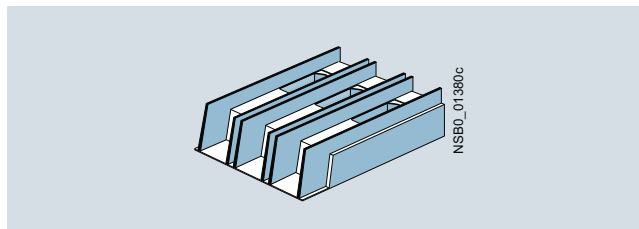

Terminal block (Type E) SIRIUS 3RT1946-4GA07

According to CSA, the terminal blocks can be omitted when the device is used as a "Self-Protected Combination Motor Controller" (Type E).

Selection and ordering data

Accessories

Version	For motor starter protectors/circuit breakers	DT	Article No.	Price per PU	PU (UNIT, SET, M)	PS*	PG	
	Size							
Covers								
<p>3RV1 (size S3) with 3RT1946-4EA1 (left) and 3RV1908-0P (right)</p>	Terminal covers for box terminals Additional touch protection to be fitted at the box terminals (2 units mountable per device)	S3	▶	3RT1946-4EA2		1	1 unit	41B
	Terminal covers For cable lug and busbar connection for maintaining the required voltage clearances and as touch protection if box terminal is removed (2 units can be mounted per motor starter protector/circuit breaker)	S3	B	3RT1946-4EA1		1	1 unit	41B
	Scale covers Sealable, for covering the set current scale	S3	▶	3RV1908-0P		100	10 units	41E
Fixing accessories								
<p>3RB1900-0B</p>	Push-in lugs For screwing the motor starter protector onto mounting plates For each motor starter protector, two units are required.	S00	A	3RB1900-0B		100	10 units	41F
Terminal blocks for "Self-Protected Combination Motor Controllers (Type E)" according to UL 508/UL 60497-4-1								
<p>3RT1946-4GA07</p>	Note: UL 508/UL 60947-4-1 approval demands 1-inch clearance and 2-inch creepage distance for "Combination Motor Controllers Type E". The following terminal blocks must be used therefore in 3RV10 motor starter protector size S3. The terminal blocks are not required for use according to CSA. With size S3, these terminal blocks cannot be used in combination with a transverse auxiliary switch.							
	Terminal block type E for extended clearance and creepage distances (1 and 2 inch)	S3	B	3RT1946-4GA07		1	1 unit	41B
Auxiliary terminals, 3-pole								
<p>3RT1946-4F</p>	For connection of auxiliary and control cables to the main conductor connections (for one side)	S3	B	3RT1946-4F		1	1 unit	41B

Motor Starter Protectors/Circuit Breakers

SIRIUS 3RV1 Motor Starter Protectors/Circuit Breakers up to 100 A Accessories

Mounting accessories

Link modules

Actuating voltage of contactor	Size	DT	Screw terminals	PU (UNIT, SET, M)	PS*	PG
	Contactors	Motor starter protectors/circuit breakers				
			Article No.	Price per PU		

Link modules from motor starter protector/circuit breaker to contactor

For mechanical and electrical connection between motor starter protector/circuit breaker and contactor with screw terminals



3RA1941-1AA00

Single-unit packaging

AC	S3	S3	▶	3RA1941-1AA00	1	1 unit	41B
DC	S3	S3	▶	3RA1941-1BA00	1	1 unit	41B

Multi-unit packaging

AC	S3	S3	▶	3RA1941-1A	1	5 units	41B
DC	S3	S3	▶	3RA1941-1B	1	5 units	41B

Miscellaneous accessories

Version	Size	Color	For motor starter protectors/circuit breakers	DT	Spring-type terminals	PU (UNIT, SET, M)	PS*	PG
			Size		Article No.	Price per PU		

Tools for opening spring-type terminals



3RA2908-1A

Screwdrivers

For all SIRIUS devices with spring-type terminals

Length approx. 200 mm, 3.0 mm x 0.5 mm

Titanium gray/black, partially insulated

S3 A

3RA2908-1A 1 1 unit 41B

Motor Starter Protectors/Circuit Breakers

SIRIUS 3RV1 Motor Starter Protectors/Circuit Breakers up to 100 A

Accessories

Front plates

Overview

Front plates

Motor starter protectors are frequently required to be actuated in any enclosure. Front plates equipped with a rotary operating mechanism for 3RV1.4. motor starter protectors/circuit breakers are available for this purpose.

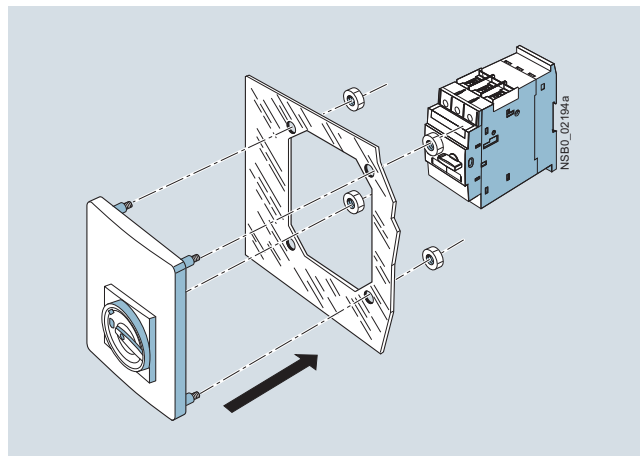

Front plate for size S3

Selection and ordering data

Version	Degree of protection	For motor starter protectors	DT	Article No.	Price per PU	PU (UNIT, SET, M)	PS*	PG
---------	----------------------	------------------------------	----	-------------	--------------	-------------------	-----	----

Front plates



3RV1923-4B

Molded-plastic front plates with rotary operating mechanism, lockable in 0 position For actuation of 3RV1 motor starter protectors in any enclosure	IP55 (front side)	S3	▶	3RV1923-4B		1	1 unit	41E
Molded-plastic front plates with EMERGENCY-STOP rotary operating mechanism, red/yellow, lockable in 0 position EMERGENCY-STOP actuation of 3RV1 motor starter protectors in any enclosure	IP55 (front side)	S3	A	3RV1923-4E		1	1 unit	41E

Version	Rated control supply voltage U_s	For motor starter protectors	DT	Article No.	Price per PU	PU (UNIT, SET, M)	PS*	PG
---------	------------------------------------	------------------------------	----	-------------	--------------	-------------------	-----	----

Indicator lights



3RV1903-5B

Indicator lights For all enclosures and front plates • With LED lamp for versions 110 ... 120 V, with glow lamp for versions 220 ... 500 V • With colored lenses red, green, yellow, orange and clear	110 ... 120	S3	C	3RV1903-5B		1	1 unit	41E
	220 ... 240		C	3RV1903-5C		1	1 unit	41E
	380 ... 415		C	3RV1903-5E		1	1 unit	41E
	480 ... 500		C	3RV1903-5G		1	1 unit	41E

Motor Starter Protectors/Circuit Breakers

SIRIUS 3RV1 Molded Case Motor Starter Protectors up to 800 A

General data

Overview



SIRIUS 3RV1063-7AL10 molded case motor starter protector

The 3RV10 and 3RV13 molded case motor starter protectors for up to 800 A are compact, current-limiting motor starter protectors which can be used above all in motor feeders for special voltages of 440 V, 480 V, 550 V and 690 V. They are used for switching and protecting three-phase motors and other loads with rated currents up to 800 A.

Note:

For motor feeders above 100 A and at 400 V and 500 V, the 3VL molded case circuit breakers must be used, see Catalog LV 10 "Low-Voltage Power Distribution and Electrical Installation Technology".

Type of construction

The molded case motor starter protectors are available in 4 widths:

- 3RV1353 – width 90 mm, max. rated current 32 A, at 550 V AC suitable for three-phase motors up to 22 kW
- 3RV1.6. – width 105 mm, max. rated current 250 A, at 690 V AC suitable for three-phase motors up to 160 kW
- 3RV1.7. – width 140 mm, max. rated current 630 A, at 690 V AC suitable for three-phase motors up to 315 kW
- 3RV1.83 – width 210 mm, max. rated current 800 A, at 690 V AC suitable for three-phase motors up to 500 kW

The 3RV1 molded case motor starter protectors for up to 800 A can be mounted in horizontal, vertical or lying arrangement directly on a mounting plate or mounting rail. Their rated data are adversely affected as the result.

The phase barriers for better insulation between the phases are included in the scope of supply, and it is essential to use them.

The motor starter protectors can be supplied through top and bottom terminals without impairing their function, enabling them to be installed in any type of switchgear without any further steps.

Connection methods

The 3RV1 molded case motor starter protectors for up to 800 A are suitable solely for screw connection.



Screw terminals

The terminals are indicated in the corresponding tables by the symbols shown on orange backgrounds.

Article No. scheme

Digit of the Article No.	1st - 3rd	4th	5th	6th	7th	8th	9th	10th	11th	12th	13th	14th	15th	16th	
	□□□	□	□	□	□	-	□	□	□	□	-	□	□	□	
Molded case motor starter protectors	3 R V														
SIRIUS 1st generation	1														
Type of motor starter protector	□														
Size	□														
Breaking capacity	□														
Setting range for overload release	□ □														
Trip class (CLASS)	□														
Connection methods	□														
With or without auxiliary switch	□														
Special versions	□ □ □ □														
Example	3 R V	1	0	6	3	-	7	A	L	1	0				

Note:

The Article No. scheme is presented here merely for information purposes and for better understanding of the logic behind the article numbers.

For your orders, please use the article numbers quoted in the catalog in the Selection and ordering data.

Motor Starter Protectors/Circuit Breakers

SIRIUS 3RV1 Molded Case Motor Starter Protectors up to 800 A

General data

Benefits

- High short-circuit breaking capacity in the feeder
- Optimum usability in motor feeders for the special voltages 440 V, 480 V, 550 V and 690 V
- Compact design
- The releases are available both in purely magnetic (up to 32 A) and in solid-state versions (100 A to 800 A)
- Available for motor or starter protection (short-circuit protection alone)

Application

Operating conditions

The 3RV1 molded case motor starter protectors for up to 800 A can be operated at ambient temperatures between -25 °C and +70 °C. They can be used according to IEC 60721-2-1 in the most difficult environmental conditions with a hot and damp climate.

Since operational currents, starting currents and current peaks are different even for motors with identical power ratings due to the inrush current, the motor ratings in the selection tables are only guide values. The specific rated and start up data of the motor to be protected is always paramount to the choice of the most suitable molded case motor starter protectors.

The 3RV1 molded case motor starter protectors up to 800 A have not been tested for use with frequency converters. The possibility of premature tripping in such applications cannot therefore be ruled out.

Possible uses

The 3RV1 molded case motor starter protectors for up to 800 A are suitable as switching and protection devices for motors. The following versions are available:

- For motor protection; the overload and short-circuit releases are designed for optimized protection and direct-on-line starting of induction squirrel-cage motors. The motor starter protectors have an electronic release which not only provides short-circuit and overload protection but is also sensitive to phase failure and phase unbalance and offers protection in the event of rotor blockage.
- For starter combinations; these molded case motor starter protectors are used for short-circuit protection in combinations of circuit breaker, motor contactor and overload relay. They are equipped with a purely magnetic release (up to 32 A) or a solid-state release (100 A to 800 A).

Standards and specifications

The electronic releases for motor protection comply with IEC 60947-4-1. Isolating features are also compliant with IEC 60947-2.

The 3RV1 molded case motor starter protectors comply in addition with IEC 60068-2-6 (shock and vibration strength) and are certified for the specifications of the most important marine classification societies:

- RINA
- Det Norske Veritas
- Bureau Veritas
- Lloyds Register of Shipping
- Germanischer Lloyd
- American Bureau of Shipping

Motor Starter Protectors/Circuit Breakers

SIRIUS 3RV1 Molded Case Motor Starter Protectors up to 800 A

General data

Technical specifications

General data		3RV1063	3RV1073	3RV1083	3RV1353	3RV1363	3RV1364	3RV1373	3RV1374	3RV1383	
Type											
Dimensions											
• W		mm	105	140	210	90	105	105	140	140	210
• H		mm	205	205	268	130	205	205	205	205	268
• D		mm	139	139	159	102	139	139	139	139	159
Standard		IEC 60947-2, EN 60947-2									
Motor protection		✓				--					
Starter combinations		--				✓					
Rated current I_n	A	160	400	630	160	250		400, 630		630, 800	
Number of poles		3									
Rated operational voltage U_e 50 ... 60 Hz AC	V	690									
Rated impulse withstand voltage U_{imp}	V	8									
Rated insulation voltage U_i	V	1 000			800		1 000				
Test voltage at industrial frequency for 1 min	V	3 500			3 000		3 500				
Rated ultimate short-circuit breaking capacity I_{cu}											
• At 220/230 V AC, 50 ... 60 Hz	kA	200			120	200					
• At 380/415 V AC, 50 ... 60 Hz	kA	120		100	85	120	200	120	200	100	
• At 440 V AC, 50 ... 60 Hz	kA	100		80	75	100	180	100	180	80	
• At 500 V AC, 50 ... 60 Hz	kA	85		65	50	85	150	85	150	65	
• At 550 V AC, 50 ... 60 Hz	kA	--			35	--					
• At 690 V AC, 50 ... 60 Hz	kA	70		30	10	70	80	70	80	30	
Rated service short-circuit breaking capacity I_{cs} (% of I_{cu})											
• At 220/230 V AC, 50 ... 60 Hz	%	100		75	100					75	
• At 380/415 V AC, 50 ... 60 Hz	%	100		75		100				75	
• At 440 V AC, 50 ... 60 Hz	%	100		75		100				75	
• At 500 V AC, 50 ... 60 Hz	%	100		75		100		100 ¹⁾ / 75 ²⁾	100	75	
• At 690 V AC, 50 ... 60 Hz	%	100		75		100		100 ¹⁾ / 50 ²⁾	100	75	
Rated short-circuit making capacity (415 V)	kA	264		220	187	264	440	264	440	220	
Break time (415 V at I_{cu})	ms	5	6	7	3	5		6		7	
Category (IEC 60947-2)		A	B (400 A), A (630 A)		B	A		B (400 A), A (630 A)		B	
Isolating features		✓									
Trip class CLASS		10A, 10, 20, 30				--					
Releases											
• Magnetic type		--			✓		--				
• Electronic (motor protection)		✓			-- ³⁾						
• Electronic (starter combinations)		--					✓				
Permissible ambient temperature											
• Operation	°C	-25 ... +70 ⁴⁾									
• Storage	°C	-40 ... +70									
Mechanical endurance											
• Operating cycles		20 000			25 000		20 000				
• Operating cycles per hour		240	120		240		120				
Electrical endurance											
• Operating cycles		8 000	7 000	5 000	8 000		7 000		5 000		
• Operating cycles per hour (415 V AC)		120	60		120		60				

✓ Has this function

-- Does not have this function

1) Value applies for 3RV1373-7GN10 molded case motor starter protectors.

2) Value applies for 3RV1373-7JN10 molded case motor starter protectors.

3) For overload protection of the motors, appropriate overload relays must be used.

4) From 50 °C, please note derating, see "Reference Manual "Protection Equipment – Circuit Breakers · Molded Case Circuit Breakers", <http://support.automation.siemens.com/WW/view/en/35681600>.

Motor Starter Protectors/Circuit Breakers

SIRIUS 3RV1 Molded Case Motor Starter Protectors up to 800 A

General data

Main circuit terminals

Type	3RV1353	3RV1.6.	3RV1.7.	3RV1083-7JL10, 3RV1383-7JN10	3RV1383-7KN10
------	---------	---------	---------	---------------------------------	---------------

Terminal dimensions

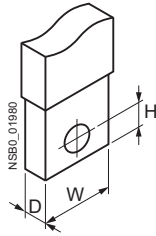

Front-accessible standard terminals

Busbars/cable lug

	Unit(s)	11			2	
Number	Unit(s)	11			2	
Dimensions						
• W	mm	20	25	35	40	50
• D	mm	5	8	10	5	
• H	mm	7.5	9.5	11	12	
• Lock hasp diameter	mm	6.5	8.5	10.5	7	

Front-extended terminals

Busbars

	Unit(s)	1		2		
Number	Unit(s)	1		2		
Dimensions						
• W	mm	20		30	40	50
• D	mm	4	10	7	5	5
• Lock hasp diameter	mm	8.5	10	11		14

Cable lug

	Unit(s)	1		2		
Number	Unit(s)	1		2		
Dimensions						
• W	mm	20		30	40	50
• Lock hasp diameter	mm	8.5	10	11		14

Front-extended cable terminals for copper cable

Busbars, flexible

	Unit(s)	1			--
Number	Unit(s)	1			--
Dimensions W x D x N					
• W	mm	13	15.5	24	--
• D	mm	0.5	0.8	1	--
• N (= number of laminations)	mm	10			--

Cable lug, flexible

	Unit(s)	1 or 2			--
Number	Unit(s)	1 or 2			--
Dimensions					
• For 1 unit	mm ²	1 ... 70	2.5 ... 120	16 ... 240	--
• For 2 units	mm ²	1 ... 50	2.5 ... 95	16 ... 150	--

Cable lug, rigid

	Unit(s)	1		1 or 2	--
Number	Unit(s)	1		1 or 2	--
Dimensions					
• For 1 unit	mm ²	1 ... 95	2.5 ... 185	16 ... 300	--
• For 2 units (for outside mounting)	mm ²	--		120 ... 240	--

Rear terminals

Busbars

	Unit(s)	1		2	
Number	Unit(s)	1		2	
Dimensions					
• W	mm	20		30	40
• D	mm	4	10	7	5
• Lock hasp diameter	mm	8.5		11	14



Motor Starter Protectors/Circuit Breakers

SIRIUS 3RV1 Molded Case Motor Starter Protectors up to 800 A

General data

Auxiliary switches

Type 3RV1991-1.A0

Rated operational current I_e

• At 250 V AC/DC			
- At AC-14 (utilization category according to IEC 60947-5-1)			
Control supply voltage 125 V	A	6	
Control supply voltage 250 V	A	5	
- At DC-13 (utilization category according to IEC 60947-5-1)			
Control supply voltage 125 V	A	0.3	
Control supply voltage 250 V	A	0.15	
• At 24 V DC			
- Control supply voltage 24 V	mA	≥ 0.75	
- Control supply voltage 5 V	mA	≥ 1	

Auxiliary releases

Molded case motor starter protectors	Power consumption during pick-up			
	3RV1353		3RV1.6., 3RV1.7., 3RV1.83	
Version	AC	DC	AC	DC
Undervoltage releases	3RV1952-1A.0		3RV1982-1A.0	
• 24 ... 30 V AC/DC	1.5 VA	1.5 W	6 VA	150 W
• 110 ... 127 V AC/110 ... 125 V DC	2 VA	2 W	6 VA	150 W
• 220 ... 240 V AC/220 ... 250 V DC	2.5 VA	2.5 W	6 VA	150 W
Opening times	ms	15	≤ 25	≤ 15
Shunt releases	3RV1952-1E.0		3RV1982-1E.0	
• 24 ... 30 V AC/DC	50 VA	50 W	150 VA	150 W
• 110 ... 127 V AC/110 ... 125 V DC	50 VA	50 W	150 VA	150 W
• 220 ... 240 V AC/220 ... 250 V DC	50 VA	50 W	150 VA	150 W
Opening times	ms	15	15	15

Motor Starter Protectors/Circuit Breakers

SIRIUS 3RV1 Molded Case Motor Starter Protectors up to 800 A

For motor protection

Selection and ordering data

CLASS 10A, 10, 20, 30; without auxiliary switch

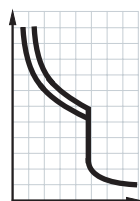

Rated current	Current setting of the inverse-time delayed overload releases "L" I_R	Operating current of the instantaneous short-circuit releases "I" I_I	Short-circuit breaking capacity at 400 V AC	DT	Screw terminals	⊕	PU (UNIT, SET, M)	PS*	PG
I_n			I_{cu}		Article No.	Price per PU			
A	A	A	kA						

With electronic releases



3RV10.3-7.L10

TU = trip unit (release)

Further accessories can be ordered separately (see "Accessories" page 7/85 onwards).

Standard switching capacity, adjustable short-circuit and overload release, TU 4

100	40 ... 100	600 ... 1 300	120	D	3RV1063-7AL10	1	1 unit	41E
160	64 ... 160	960 ... 2 080	120	D	3RV1063-7CL10	1	1 unit	41E
200	80 ... 200	1 200 ... 2 600	120	D	3RV1063-7DL10	1	1 unit	41E
400	160 ... 400	2 400 ... 5 200	120	D	3RV1073-7GL10	1	1 unit	41E
630	252 ... 630	3 780 ... 8 190	100	D	3RV1083-7JL10	1	1 unit	41E

Motor Starter Protectors/Circuit Breakers

SIRIUS 3RV1 Molded Case Motor Starter Protectors up to 800 A

For starter combinations

Selection and ordering data

Without auxiliary switches

Rated current I_n A	Inverse-time delayed overload release "L" I_R A	Operating current of the instantaneous short-circuit releases "I" I_i A	Short-circuit breaking capacity at 400 V AC I_{cu} kA	DT	Screw terminals	PU (UNIT, SET, M)	PS*	PG

With magnetic releases



3RV1353-6.P10

Standard switching capacity, non-adjustable short-circuit release, TU 1

1	Without	13	85	D	3RV1353-6AP10	1	1 unit	41E
1.6	Without	21	85	D	3RV1353-6BP10	1	1 unit	41E
2	Without	26	85	D	3RV1353-6CP10	1	1 unit	41E
3.2	Without	42	85	D	3RV1353-6DP10	1	1 unit	41E
4	Without	52	85	D	3RV1353-6EP10	1	1 unit	41E
5	Without	65	85	D	3RV1353-6FP10	1	1 unit	41E
6.5	Without	85	85	D	3RV1353-6GP10	1	1 unit	41E
8.5	Without	111	85	D	3RV1353-6HP10	1	1 unit	41E
12.5	Without	163	85	D	3RV1353-6JP10	1	1 unit	41E

Standard switching capacity, adjustable short-circuit release, TU 2

20	Without	120 ... 240	85	D	3RV1353-6LM10	1	1 unit	41E
32	Without	192 ... 384	85	D	3RV1353-6MM10	1	1 unit	41E

With electronic releases



3RV13...-7.N10

Standard switching capacity, adjustable short-circuit release, TU 3

100	Without	100 ... 1 000	120	D	3RV1363-7AN10	1	1 unit	41E
160	Without	160 ... 1 600	120	D	3RV1363-7CN10	1	1 unit	41E
250	Without	250 ... 2 500	120	D	3RV1363-7EN10	1	1 unit	41E
400	Without	400 ... 4 000	120	D	3RV1373-7GN10	1	1 unit	41E
630	Without	630 ... 6 300	120	D	3RV1373-7JN10	1	1 unit	41E
630	Without	630 ... 6 300	100	D	3RV1383-7JN10	1	1 unit	41E
800	Without	800 ... 8 000	100	D	3RV1383-7KN10	1	1 unit	41E

Increased switching capacity, adjustable short-circuit release, TU 3

100	Without	100 ... 1 000	200	D	3RV1364-7AN10	1	1 unit	41E
160	Without	160 ... 1 600	200	D	3RV1364-7CN10	1	1 unit	41E
250	Without	250 ... 2 500	200	D	3RV1364-7EN10	1	1 unit	41E
400	Without	400 ... 4 000	200	D	3RV1374-7GN10	1	1 unit	41E

TU = trip unit (release)

Further accessories can be ordered separately
(see "Accessories" page 7/85 onwards).

More information

Manual

Configuration Manual "SIRIUS Configuration – Selection Data for Fuseless Load Feeders", see
<http://support.automation.siemens.com/WW/view/en/68115040>.

Motor Starter Protectors/Circuit Breakers

SIRIUS 3RV1 Molded Case Motor Starter Protectors up to 800 A

Accessories

Mountable accessories

Selection and ordering data

Type	Version	For molded case motor starter protectors	DT	Screw terminals	⊕	PU (UNIT, SET, M)	PS*	PG
				Article No.	Price per PU			

Auxiliary switches



3RV1991-1AA0

Auxiliary switches for front mounting	1 signaling switch Off-On + 1 tripped signal (250 V AC/DC)	3RV1353, 3RV1.6, ...	D	3RV1991-1AA0		1	1 unit	41E
	3 signaling switches Off-On + 1 tripped signal (250 V AC/DC)	3RV1.83	D	3RV1991-1BA0		1	1 unit	41E
	3 signaling switches Off-On + 1 tripped signal (24 V DC)		D	3RV1991-1CA0		1	1 unit	41E
Connection cables for auxiliary switches	Length 2 m, 6-pole	3RV1353, 3RV1.6, ...	D	3RV1991-1FA0		1	1 unit	41E

Type	Rated control supply voltage U_s		For molded case motor starter protectors	DT	Screw terminals	⊕	PU (UNIT, SET, M)	PS*	PG
		AC	DC						
		50/60 Hz							
		V	V						
				Article No.	Price per PU				

Auxiliary releases



3RV1952-1AA0

Undervoltage releases for front mounting	24 ... 30	24 ... 30	3RV1353	D	3RV1952-1AA0		1	1 unit	41E
	110 ... 127	110 ... 125		D	3RV1952-1AD0		1	1 unit	41E
	220 ... 240	220 ... 250		D	3RV1952-1AE0		1	1 unit	41E
	24 ... 30	24 ... 30	3RV1.6.	D	3RV1982-1AA0		1	1 unit	41E
	110 ... 127	110 ... 125	...	D	3RV1982-1AD0		1	1 unit	41E
	220 ... 240	220 ... 250	3RV1.83	D	3RV1982-1AF0		1	1 unit	41E
Shunt releases for front mounting	24 ... 30	24 ... 30	3RV1353	D	3RV1952-1EA0		1	1 unit	41E
	110 ... 127	110 ... 125		D	3RV1952-1ED0		1	1 unit	41E
	220 ... 240	220 ... 250		D	3RV1952-1EF0		1	1 unit	41E
	24 ... 30	24 ... 30	3RV1.6.	D	3RV1982-1EA0		1	1 unit	41E
	110 ... 127	110 ... 125	...	D	3RV1982-1ED0		1	1 unit	41E
	220 ... 240	220 ... 250	3RV1.83	D	3RV1982-1EF0		1	1 unit	41E
Connection cables for undervoltage and shunt releases	Length 2 m, 6-pole	3RV1353, 3RV1.6, ...	D	3RV1992-1FA0		1	1 unit	41E	





3RV1952-1EA0

Motor Starter Protectors/Circuit Breakers

SIRIUS 3RV1 Molded Case Motor Starter Protectors up to 800 A Accessories

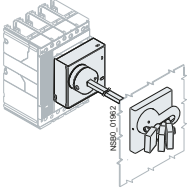
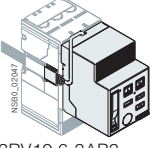
Rotary operating mechanisms, mounting accessories

Selection and ordering data

Version	For molded case motor starter protectors	DT	Screw terminals 	PU (UNIT, SET, M)	PS*	PG		
			Article No.	Price per PU				
Rotary operating mechanisms								
	Lever-type rotary operating mechanisms	With adjustable distance, with lock/door interlocking (padlocks are not included in scope of supply)	3RV1.353	D	3RV1956-0BA0	1	1 unit	41E
			3RV1.6., 3RV1.7.	D	3RV1976-0BA0	1	1 unit	41E
			3RV1.83	D	3RV1986-0BA0	1	1 unit	41E
3RV19.6-0BA0								
	Motorized operating mechanisms	With stored energy mechanism, 220 ... 250 V AC/DC	3RV1.6., 3RV1.7.	D	3RV1976-3AP3	1	1 unit	41E
			3RV1.83	D	3RV1986-3AP3	1	1 unit	41E
3RV19.6-3AP3								
Connections								
	Connections	Front-extended (1 set = 6 units)	3RV1.353	D	3RV1955-1AA0	1	1 unit	41E
			3RV1.6.	D	3RV1965-1BA0	1	1 unit	41E
			3RV1.7.	D	3RV1975-1CA0	1	1 unit	41E
			3RV1.83-7J.10	D	3RV1985-1DA0	1	1 unit	41E
			3RV1.83-7KN10	D	3RV1985-1EA0	1	1 unit	41E
3RV1975-1CA0								
		Rear (1 set = 3 units)	3RV1.353	D	3RV1955-3AA0	1	1 unit	41E
			3RV1.6.	D	3RV1965-3AA0	1	1 unit	41E
			3RV1.7.	D	3RV1975-3AA0	1	1 unit	41E
			3RV1.83	D	3RV1985-3AA0	1	1 unit	41E
3RV1955-3AA0								
	Cable terminals	Front-extended (1 set = 6 units)	3RV1.353	D	3RV1955-2AA0	1	1 unit	41E
			3RV1.6.	D	3RV1965-2BA0	1	1 unit	41E
			3RV1.7.-7G.10	D	3RV1975-2CA0	1	1 unit	41E
			3RV1.73-7JN10	D	3RV1975-2DA0	1	1 unit	41E
3RV1975-2AA0								

Overview



Features	3RU21	3RU11	3RB30/3RB31	3RB20/3RB21	3RB22/3RB23	3RB24	Benefits
General data							
Sizes	S00 ... S2	S3	S00 ... S2	S3 ... S12	S00 ... S12	S00 ... S12	<ul style="list-style-type: none"> • Are coordinated with the dimensions, connections and technical characteristics of the other devices in the SIRIUS modular system (contactors, etc., ...) • Permit the mounting of slim and compact load feeders in widths of 45 mm (S00, S0), 55 mm (S2), 70 mm (S3), 120 mm (S6) and 145 mm (S10/S12); this does not include the current measuring modules for the 3RB22 to 3RB24 evaluation modules sizes S00 to S3 • Simplify configuration
Seamless current range	0.11 ... 80 A	18 ... 100 A	0.1 ... 80 A	12.5 ... 630 A	0.3 ... 630 A (up to 820 A) ¹⁾	0.3 ... 630 A (up to 820 A) ¹⁾	<ul style="list-style-type: none"> • Allows easy and consistent configuration with one series of overload relays (for small to large loads)
Protection functions							
Tripping due to overload	✓	✓	✓	✓	✓	✓	<ul style="list-style-type: none"> • Provides optimum inverse-time delayed protection of loads against excessive temperature rises due to overload
Tripping due to phase unbalance	✓	✓	✓	✓	✓	✓	<ul style="list-style-type: none"> • Provides optimum inverse-time delayed protection of loads against excessive temperature rises due to phase unbalance
Tripping due to phase failure	✓	✓	✓	✓	✓	✓	<ul style="list-style-type: none"> • Minimizes heating of three-phase motors during phase failure
Protection of single-phase loads	✓	✓	--	--	✓	✓	<ul style="list-style-type: none"> • Enables the protection of single-phase loads
Tripping in the event of overheating by integrated thermistor motor protection function	-- ²⁾	-- ²⁾	-- ²⁾	-- ²⁾	✓	✓	<ul style="list-style-type: none"> • Provides optimum temperature-dependent protection of loads against excessive temperature rises e.g. for stator-critical motors or in the event of insufficient coolant flow, contamination of the motor surface or for long starting or braking operations • Eliminates the need for additional special equipment • Saves space in the control cabinet • Reduces wiring outlay and costs
Tripping in the event of a ground fault by internal ground-fault detection (activatable)	--	--	✓ (only 3RB31)	✓ (only 3RB21)	✓	✓	<ul style="list-style-type: none"> • Provides optimum protection of loads against high-resistance short circuits or ground faults due to moisture, condensed water, damage to the insulation material, etc. • Eliminates the need for additional special equipment • Saves space in the control cabinet • Reduces wiring outlay and costs

✓ Available
-- Not available

¹⁾ Motor currents up to 820 A can be recorded and evaluated by a current measuring module, e.g. 3RB2906-2BG1 (0.3 to 3 A), in combination with a 3UF1868-3GA00 (820 A/1 A) series transformer.
3UF18 transformers, see Chapter 10, "Monitoring and Control Devices" → "SIMOCODE 3UF Motor Management and Control Devices".

²⁾ The SIRIUS 3RN thermistor motor protection devices can be used to provide additional temperature-dependent protection.

Overload Relays

General data



Features	3RU21	3RU11	3RB30/3RB31	3RB20/3RB21	3RB22/3RB23	3RB24	Benefits
Features							
RESET function	✓	✓	✓	✓	✓	✓	<ul style="list-style-type: none"> Allows manual or automatic resetting of the device
Remote RESET function	✓ (by means of separate module)	✓ (by means of separate module)	✓ (only with 3RB31 and external auxiliary voltage 24 V DC)	✓ (only with 3RB21 and external auxiliary voltage 24 V DC)	✓ (electrically via external button)	✓ (electrically with button or via IO-Link)	<ul style="list-style-type: none"> Allows the remote resetting of the device
TEST function for auxiliary contacts	✓	✓	✓	✓	✓	✓	<ul style="list-style-type: none"> Allows easy checking of the function and wiring
TEST function for electronics	--	--	✓	✓	✓	✓	<ul style="list-style-type: none"> Allows checking of the electronics
Status display	✓	✓	✓	✓	✓	✓	<ul style="list-style-type: none"> Displays the current operating state
Large current adjustment button	✓	✓	✓	✓	✓	✓	<ul style="list-style-type: none"> Makes it easier to set the relay exactly to the correct current value
Integrated auxiliary contacts (1 NO + 1 NC)	✓	✓	✓	✓	✓ (2 ×)	--	<ul style="list-style-type: none"> Allows the load to be switched off if necessary Can be used to output signals
Integrated auxiliary contacts (1 CO and 1 NO in series)	--	--	--	--	--	✓	<ul style="list-style-type: none"> Enables the controlling of contactors directly from the higher-level control system through IO-Link
IO-Link connection	--	--	--	--	--	✓	<ul style="list-style-type: none"> Reduction of wiring in the control cabinet Enables communication
Connection of optional handheld device	--	--	--	--	--	✓	<ul style="list-style-type: none"> Enables local operation
Communication capability through IO-Link							
Full starter functionality through IO-Link	--	--	--	--	--	✓	<ul style="list-style-type: none"> Enables in combination with the SIRIUS 3RT contactors the assembly of communication-capable motor starters (direct-on-line, reversing and wye-delta starting)
Reading out of diagnostics functions	--	--	--	--	--	✓	<ul style="list-style-type: none"> Enables the reading out of diagnostics information such as overload, open circuit, ground fault, etc.
Reading out of current values	--	--	--	--	--	✓	<ul style="list-style-type: none"> Enables the reading out of current values and their direct processing in the higher-level control system
Reading out all set parameters	--	--	--	--	--	✓	<ul style="list-style-type: none"> Enables the reading out of all set parameters, e.g. for plant documentation

✓ Available

-- Not available



Features	3RU21	3RU11	3RB30/3RB31	3RB20/3RB21	3RB22/3RB23	3RB24	Benefits
Design of load feeders							
Short-circuit strength up to 100 kA at 690 V (in conjunction with the corresponding fuses or the corresponding motor starter protector)	✓	✓	✓	✓	✓	✓	<ul style="list-style-type: none"> Provides optimum protection of the loads and operating personnel in the event of short circuits due to insulation faults or faulty switching operations
Electrical and mechanical matching to 3RT contactors	✓	✓	✓	✓	✓ ¹⁾	✓ ¹⁾	<ul style="list-style-type: none"> Simplifies configuration Reduces wiring outlay and costs Enables stand-alone installation as well as space-saving direct mounting
Straight-through transformers for main circuit²⁾ (in this case the cables are routed through the feed-through openings of the overload relay and connected directly to the box terminals of the contactor)	--	--	✓ (S2)	✓ (S3 ... S6)	✓ (S00 ... S6)	✓ (S00 ... S6)	<ul style="list-style-type: none"> Reduces the contact resistance (only one point of contact) Saves wiring costs (easy, no need for tools, and fast) Saves material costs Reduces installation costs
Spring-type connection system for main circuit²⁾	✓ (S00, S0)	--	✓ (S00, S0)	--	--	--	<ul style="list-style-type: none"> Enables fast connections Permits vibration-resistant connections Enables maintenance-free connections
Spring-type connection system for auxiliary circuits²⁾	✓	✓	✓	✓	✓	✓	<ul style="list-style-type: none"> Enables fast connections Permits vibration-resistant connections Enables maintenance-free connections
Ring terminal lug connection system for main and auxiliary circuits²⁾	✓ (S00, S0)	--	--	--	--	--	<ul style="list-style-type: none"> Enables fast connections Permits vibration-resistant connections Enables maintenance-free connections
Full starter functionality through IO-Link	--	--	--	--	--	✓	<ul style="list-style-type: none"> Enables in combination with the SIRIUS 3RT contactors the assembly of communication-capable motor starters (direct-on-line, reversing and wye-delta starting)
Starter function	--	--	--	--	--	✓	<ul style="list-style-type: none"> Integration of feeders via IO-Link in the control system up to 630 A or 820 A

✓ Available
-- Not available

¹⁾ Exception: up to size S3, only stand-alone installation is possible.

²⁾ Alternatively available for screw terminals.

Overload Relays

General data



Features	3RU21	3RU11	3RB30/3RB31	3RB20/3RB21	3RB22/3RB23	3RB24	Benefits
Other features							
Temperature compensation	✓	✓	✓	✓	✓	✓	<ul style="list-style-type: none"> Allows the use of the relays at high temperatures without derating Prevents premature tripping Allows compact installation of the control cabinet without distance between the devices/load feeders Simplifies configuration Enables space to be saved in the control cabinet
Very high long-term stability	✓	✓	✓	✓	✓	✓	<ul style="list-style-type: none"> Provides safe protection for the loads even after years of use in severe operating conditions
Wide setting ranges	--	--	✓ (1:4)	✓ (1:4)	✓ (1:10)	✓ (1:10)	<ul style="list-style-type: none"> Minimize the configuration outlay and costs Minimize storage overheads, storage costs, tied-up capital
Fixed trip class	CLASS 10, CLASS 10A	CLASS 10	3RB30: CLASS 10E or CLASS 20E	3RB20: CLASS 10 or CLASS 20	--	--	<ul style="list-style-type: none"> Optimum motor protection for standard starts
Trip classes adjustable on the device CLASS 5E, 10E, 20E, 30E	--	--	3RB31: ✓	3RB21: ✓	✓	✓	<ul style="list-style-type: none"> Enables solutions for very fast starting motors requiring special protection (e.g. Ex motors) Enables heavy starting solutions Reduces the number of variants Minimizes the configuring outlay and costs Minimizes storage overhead, storage costs, and tied-up capital
Low power loss	--	--	✓	✓	✓	✓	<ul style="list-style-type: none"> Reduces energy consumption and energy costs (up 98 % less energy is used than for thermal overload relays) Minimizes temperature rises of the contactor and control cabinet – in some cases this may eliminate the need for control-gear cabinet cooling Direct mounting to contactor saves space, even for high motor currents (i.e. no heat decoupling is required)
Internal power supply	-- ¹⁾	-- ¹⁾	✓	✓	--	--	<ul style="list-style-type: none"> Eliminates the need for configuration and connecting an additional control circuit
Supplied from an external voltage through IO-Link	--	--	--	--	--	✓	

✓ Available
-- Not available

¹⁾ SIRIUS 3RU11 and 3RU21 thermal overload relays use a bimetal contactor and therefore do not require a control supply voltage.



Features	3RU21	3RU11	3RB30/3RB31	3RB20/3RB21	3RB22/3RB23	3RB24	Benefits
Other characteristics (continued)							
Overload warning	--	--	--	--	✓	✓	<ul style="list-style-type: none"> Indicates imminent tripping of the relay directly on the device due to overload, phase unbalance or phase failure through flickering of the LEDs or in the case of the 3RB24 as a signal through IO-Link Allows the imminent tripping of the relay to be signaled Allows measures to be taken in time in the event of inverse-time delayed overloading of the load for an extended period over the current limit Eliminates the need for an additional device Saves space in the control cabinet Reduces wiring outlay and costs
Analog output	--	--	--	--	✓	✓	<ul style="list-style-type: none"> Allows the output of an analog output signal for actuating moving-coil instruments, feeding programmable logic controllers or transfer to bus systems Eliminates the need for an additional measuring transducer and signal converter Saves space in the control cabinet Reduces wiring outlay and costs

✓ Available
 -- Not available



Overload Relays

General data

Overview of overload relays – matching contactors

Overload relays	Current measurement	Current range	Contactors (type, size, rating in kW)							
			3RT201.	3RT202.	3RT203.	3RT104.	3RT105.	3RT106.	3RT107.	3TF68/3TF69
			S00	S0	S2	S3	S6	S10	S12	S14
Type	A		3/4/5.5/7.5	5.5/7.5/11/15/18.5	15/18.5/22/30/37/45	30/37/45	55/75/90	110/132/160	200/250	375/450

SIRIUS 3RU21 thermal overload relays



3RU211	Integrated	0.11 ... 16	✓	--	--	--	--	--	--	--
3RU212	Integrated	1.8 ... 40	--	✓	--	--	--	--	--	--
3RU213	Integrated	11 ... 80	--	--	✓	--	--	--	--	--

3RU21

SIRIUS 3RU11 thermal overload relays



3RU114	Integrated	18 ... 100	--	--	--	✓	--	--	--	--
--------	------------	------------	----	----	----	---	----	----	----	----

3RU11

SIRIUS 3RB30 electronic overload relays¹⁾



3RB301	Integrated	0.1 ... 16	✓	--	--	--	--	--	--	--
3RB302	Integrated	0.1 ... 40	--	✓	--	--	--	--	--	--
3RB303	Integrated	12.5 ... 80	--	--	✓	--	--	--	--	--

3RB30

SIRIUS 3RB31 electronic overload relays¹⁾



3RB311	Integrated	0.1 ... 16	✓	--	--	--	--	--	--	--
3RB312	Integrated	0.1 ... 40	--	✓	--	--	--	--	--	--
3RB313	Integrated	12.5 ... 80	--	--	✓	--	--	--	--	--

3RB20

SIRIUS 3RB20 electronic overload relays¹⁾



3RB204	Integrated	12.5 ... 100	--	--	--	✓	--	--	--	--
3RB205	Integrated	50 ... 200	--	--	--	--	✓	--	--	--
3RB206	Integrated	55 ... 630	--	--	--	--	--	✓	✓	✓
3RB201 + 3UF18	Integrated	630 ... 820	--	--	--	--	--	--	--	✓

3RB20

SIRIUS 3RB21 electronic overload relays¹⁾

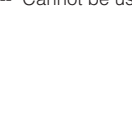

3RB214	Integrated	12.5 ... 100	--	--	--	✓	--	--	--	--
3RB215	Integrated	50 ... 200	--	--	--	--	✓	--	--	--
3RB216	Integrated	55 ... 630	--	--	--	--	--	✓	✓	✓
3RB211 + 3UF18	Integrated	630 ... 820	--	--	--	--	--	--	--	✓

3RB21



✓ Can be used
-- Cannot be used

¹⁾ "Technical specifications" for the use of overload relays with trip class ≥ CLASS 20 can be found in "Short-circuit protection with fuses for motor feeders", see Configuration Manuals
- "SIRIUS Configuration – Selection data for Fuseless Load Feeders", <http://support.automation.siemens.com/WW/view/en/68115040>.
- "Configuring SIRIUS Innovations – Selection data for Fuseless and Fused Load Feeders", <http://support.automation.siemens.com/WW/view/en/50250599>.

Overview of overload relays – matching contactors (continued)

Overload relays	Current measuring module	Current range	Contactors (type, size, rating in kW)							
			3RT201.	3RT202.	3RT203.	3RT104.	3RT105.	3RT106.	3RT107.	3TF68/3TF69
			S00	S0	S2	S3	S6	S10	S12	S14
Type	A		3/4/5.5/7.5	5.5/7.5/11/15/18.5	15/18.5/22/30/37	30/37/45	55/75/90	110/132/160	200/250	375/450

SIRIUS 3RB22 to 3RB24 electronic overload relays¹⁾

 3RB22, 3RB23	3RB2906	0.3 ... 25	✓	✓	--	--	--	--	--	--	
	3RB2906	10 ... 100	✓	✓	✓	✓	--	--	--	--	
	3RB2283/ 3RB2383/ 3RB2483+	3RB2956	20 ... 200	--	✓	✓	✓	✓	--	--	--
	3RB2966	63 ... 630	--	--	--	--	--	✓	✓	✓	
	3RB2906 + 3UF18	630 ... 820	--	--	--	--	--	--	--	✓	
 3RB24											

✓ Can be used
 -- Cannot be used

¹⁾ "Technical Specifications" for the use of overload relays with trip class \geq CLASS 20 can be found in "Short-circuit protection with fuses for motor feeders", see Configuration Manuals
 - "SIRIUS Configuration – Selection Data for Fuseless Load Feeders", <http://support.automation.siemens.com/WW/view/en/68115040>
 - "Configuring SIRIUS Innovations – Selection Data for Fuseless and Fused Load Feeders", <http://support.automation.siemens.com/WW/view/en/50250599>.



Overload Relays

General data

Connection methods

3RU2 thermal overload relays

- Sizes S00 and S0:
 - Main and auxiliary circuit: Either screw terminals, spring-type terminals or ring terminal lug connections
- Size S2:
 - Main circuit: Screw terminals with box terminal
 - Auxiliary circuit: Either screw or spring-type terminals

3RU1 thermal overload relays

- Size S3:
 - Main circuit: Screw terminals
 - Auxiliary circuit: Either screw or spring-type terminals

3RB3 electronic overload relays

- Sizes S00 and S0:
 - Main and auxiliary circuit: Either screw or spring-type terminals
- Size S2:
 - Main circuit: Screw terminals with box terminal or as straight-through transformer
 - Auxiliary circuit: Either screw or spring-type terminals

3RB2 electronic overload relays

3RB20 and 3RB21 overload relays:

- Size S3:
 - Main circuit: Screw terminals with box terminal or as straight-through transformer
 - Auxiliary circuit: Either screw or spring-type terminals
- Size S6:
 - Main circuit: With busbar connection or as straight-through transformer
 - Auxiliary circuit: Either screw or spring-type terminals
- Sizes S10/S12:
 - Main circuit: With busbar connection
 - Auxiliary circuit: Either screw or spring-type terminals

3RB22 to 3RB24 evaluation modules:

- Screw or spring-type terminals

3RB29 current measuring modules:

- Up to size S3: Straight-through transformers
- As from size S6:
 - Main circuit: With busbar connection
 - Auxiliary circuit: Either screw or spring-type terminals



Screw terminals



Spring-type terminals



Ring terminal lug connections



Busbar connections



Straight-through transformers

The various terminals and straight-through transformers are indicated in the corresponding tables by the symbols shown on orange backgrounds.

Overview

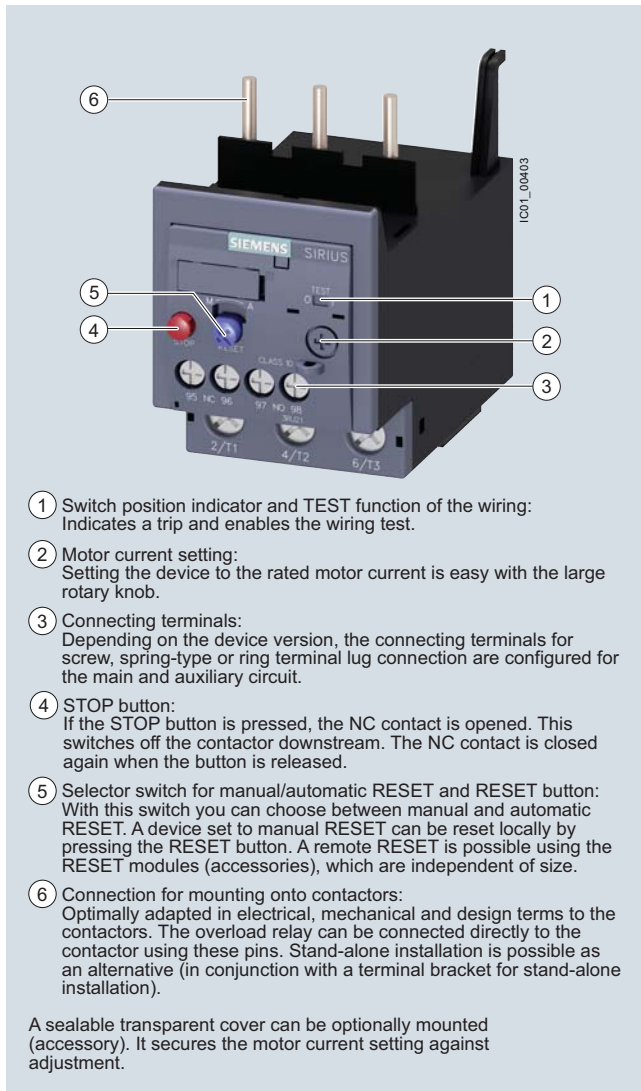

- ① Switch position indicator and TEST function of the wiring:
Indicates a trip and enables the wiring test.
- ② Motor current setting:
Setting the device to the rated motor current is easy with the large rotary knob.
- ③ Connecting terminals:
Depending on the device version, the connecting terminals for screw, spring-type or ring terminal lug connection are configured for the main and auxiliary circuit.
- ④ STOP button:
If the STOP button is pressed, the NC contact is opened. This switches off the contactor downstream. The NC contact is closed again when the button is released.
- ⑤ Selector switch for manual/automatic RESET and RESET button:
With this switch you can choose between manual and automatic RESET. A device set to manual RESET can be reset locally by pressing the RESET button. A remote RESET is possible using the RESET modules (accessories), which are independent of size.
- ⑥ Connection for mounting onto contactors:
Optimally adapted in electrical, mechanical and design terms to the contactors. The overload relay can be connected directly to the contactor using these pins. Stand-alone installation is possible as an alternative (in conjunction with a terminal bracket for stand-alone installation).

A sealable transparent cover can be optionally mounted (accessory). It secures the motor current setting against adjustment.

SIRIUS 3RU2136-4.B0 thermal overload relay

Article No. scheme

Digit of the Article No.	1st - 3rd	4th	5th	6th	7th	8th	9th	10th	11th	
	□□□	□	□	□	□	-	□	□	□	
Thermal overload relays	3 R U									
SIRIUS 2nd generation	2									
Device series	□									
Size, rated operational current and power	□ □									
Setting range of the overload release	□ □									
Connection methods	□									
Installation type	□									
Example	3 R U	2	1	1	6	-	0	A	B	0

Note:

The Article No. scheme is presented here merely for information purposes and for better understanding of the logic behind the article numbers.

For your orders, please use the article numbers quoted in the catalog in the Selection and ordering data.

The 3RU21 thermal overload relays up to 80 A have been designed for inverse-time delayed protection of loads with normal starting (for "Function", see manual "SIRIUS Innovations – SIRIUS 3RU2/3RB3 Overload Relays", <http://support.automation.siemens.com/WW/view/en/60298164>) against excessive temperature rises due to overload or phase failure.

An overload or phase failure results in an increase of the motor current beyond the set rated motor current. Via heating elements, this current rise heats up the bimetal strips inside the device which then bend and as a result trigger the auxiliary contacts by means of a tripping mechanism. The auxiliary contacts then switch off the load by means of a contactor. The break time depends on the ratio between the tripping current and current setting I_e and is stored in the form of a long-term stable tripping characteristic (see "Characteristic Curves" <http://support.automation.siemens.com/WW/view/en/34291410/134300>).

The "tripped" status is signaled by means of a switch position indicator. Resetting takes place either manually or automatically after a recovery time has elapsed (for "Function", see manual "SIRIUS Innovations – SIRIUS 3RU2/3RB3 Overload Relays", <http://support.automation.siemens.com/WW/view/en/60298164>).

The 3RU2 thermal overload relays are suitable for operation with frequency converters. Please follow the instructions in the manual "SIRIUS Innovations – 3RU2/3RB3 Overload Relays", see <http://support.automation.siemens.com/WW/view/en/60298164>.

The devices are manufactured in accordance with environmental guidelines and contain environmentally friendly and reusable materials. They comply with all important worldwide standards and approvals.

3RU11 overload relays for currents over 80 A in size S3, see page 7/111 onwards.

Use in hazardous areas

The 3RU21 thermal overload relays are suitable for the protection of motors with "Flameproof enclosure d" or "Increased safety e" types of protection.

EC type test certificate for Category (2) G/D exists. It has the number DMT 98 ATEX G001.

Overload Relays

SIRIUS 3RU2 Thermal Overload Relays

3RU2 up to 80 A for standard applications

Benefits

The most important features and benefits of the 3RU21 thermal overload relays are listed in the overview table (see "General Data", page 7/87 onwards).

Application

Industries

The 3RU21 thermal overload relays are suitable for customers from all industries who want to guarantee optimum inverse-time delayed protection of their electrical loads (e.g. motors) under normal starting conditions (CLASS 10, 10A).

Application

The 3RU21 thermal overload relays have been designed for the protection of three-phase and single-phase AC and DC motors.

Note:

For the use of 3RU21 thermal overload relays in conjunction with highly energy-efficient IE3 motors, please read the information on dimensioning and configuration, see "Configuration Manual for SIRIUS Controls with IE3 Motors", <http://support.automation.siemens.com/WW/view/en/94770820>

More information, see page 3.

If single-phase AC or DC loads are to be protected by the 3RU21 thermal overload relays, all three bimetal strips must be heated. For this purpose, all main current paths of the relay must be connected in series.

Ambient conditions



The 3RU21 thermal overload relays have temperature compensation according to IEC 60947-4-1 for the temperature range of -40 to +60 °C. For temperatures from +60 to +70 °C, the upper set value of the setting range must be reduced by the factor listed in the table below.

Technical specifications

The following technical information is intended to provide an initial overview of the various types of device and functions.

Detailed information, see

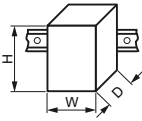
- Manual "SIRIUS Innovations – SIRIUS 3RU2/3RB3 Overload Relays", <http://support.automation.siemens.com/WW/view/en/60298164>
- or specific information on a particular article number via the product data sheet, <http://support.automation.siemens.com/WW/view/en/34291410/133200>

Type		3RU2116	3RU2126	3RU2136
Size		S00	S0	S2
Dimensions (W x H x D) (overload relay with stand-alone installation support)				
• Screw terminals	mm	45 x 89 x 80	45 x 97 x 95	55 x 105 x 117
• Spring-type terminals	mm	45 x 102 x 79	45 x 114 x 95	55 x 105 x 117
General data				
Trips in the event of		Overload and phase failure		
Trip class acc. to IEC 60947-4-1	Class	10		10, 10A
Phase failure sensitivity		Yes		
Overload warning		No		
Reset and recovery		Manual, Automatic and Remote RESET (Remote RESET in combination with the corresponding accessories)		
• Reset options after tripping				
• Recovery time		Depends on the strength of the tripping current and characteristic		
- For automatic RESET	min.	Depends on the strength of the tripping current and characteristic		
- For manual RESET	min.	Depends on the strength of the tripping current and characteristic		
- For remote RESET	min.	Depends on the strength of the tripping current and characteristic		
Features		Yes, by means of TEST function/switch position indicator slide		
• Display of operating state on device		Yes		
• TEST function		Yes		
• RESET button		Yes		
• STOP button		Yes		
Protection and operation of motors with "Increased safety e" and "Flameproof enclosure d" types of protection		DMT 98 ATEX G 001  II (2) GD see http://support.automation.siemens.com/WW/view/en/47205444		
EC type test certificate number according to directive 94/9/EC (ATEX)				On request

Overload Relays

SIRIUS 3RU2 Thermal Overload Relays

3RU2 up to 80 A for standard applications

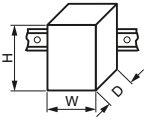
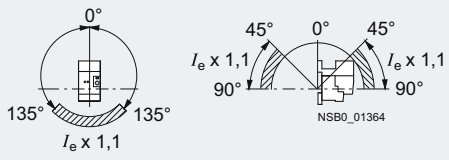
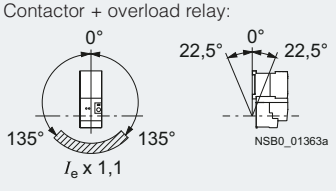
Type		3RU2116	3RU2126	3RU2136
Size		S00	S0	S2
Dimensions (W x H x D) (overload relay with stand-alone installation support)				
• Screw terminals	mm	45 x 89 x 80	45 x 97 x 95	55 x 105 x 117
• Spring-type terminals	mm	45 x 102 x 79	45 x 114 x 95	55 x 105 x 117
General data (continued)				
Ambient temperature				
• Storage/transport	°C	-55 ... +80		
• Operation	°C	-40 ... +70		
• Temperature compensation	°C	Up to +60		
• Permissible rated current at				
- Temperature inside control cabinet 60 °C	%	100 (over +60 °C current reduction is not required)		
- Temperature inside control cabinet 70 °C	%	87		
Repeat terminals				
• Coil repeat terminals		Yes	Not required	
• Auxiliary contact repeat terminal		Yes	Not required	
Degree of protection acc. to IEC 60529				
		IP20		
Touch protection acc. to IEC 61140				
• Screw terminals and spring-type terminals		Finger-safe for vertical contact from the front		
• Ring terminal lug connections		Finger-safe only with optional terminal covers		
Shock resistance with sine acc. to IEC 60068-2-27				
	g/ms	15/11 (auxiliary contacts 95/96 and 97/98: 8 g/11 ms)		
Electromagnetic compatibility (EMC)				
• Interference immunity		Not relevant		
• Emitted interference		Not relevant		
Resistance to extreme climates – air humidity				
	%	90		
Dimensions				
		"Dimensional drawings", see <ul style="list-style-type: none"> • Manual "SIRIUS Innovations – SIRIUS 3RU2/3RB3 Overload Relays", http://support.automation.siemens.com/WW/view/en/60298164 • Product data sheet, http://support.automation.siemens.com/WW/view/en/34291410/133200 		
Installation altitude above sea level				
	m	Up to 2 000; above this on request		
Mounting position				
		<p>The diagrams show the permissible mounting positions for mounting onto contactors and stand-alone installation. For mounting position in the hatched area, a setting correction of 10 % must be implemented.</p> <p>Stand-alone installation:</p>  <p>Contactor + overload relay:</p> 		
Type of mounting				
		Mounting onto contactor/stand-alone installation with terminal support (For screw and snap-on mounting onto TH 35 standard mounting rail. Technical specifications of the terminal supports, see manual SIRIUS Innovations – SIRIUS 3RU2/3RB3 Overload Relays", http://support.automation.siemens.com/WW/view/en/60298164 .)		

Overload Relays

SIRIUS 3RU2 Thermal Overload Relays

3RU2 up to 80 A for standard applications

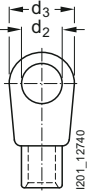

Type		3RU2116	3RU2126	3RU2136
Size		S00	S0	S2
Main circuit				
Rated insulation voltage U_i (pollution degree 3)	V	690		
Rated impulse withstand voltage U_{imp}	kV	6		
Rated operational voltage U_e	V	690		
Type of current				
• Direct current		Yes		
• Alternating current		Yes, frequency range up to 400 Hz		
Current setting				
	A	0.11 ... 0.16 up to	1.8 ... 2.5 up to	11 ... 16 up to
	A	11 ... 16	34 ... 40	70 ... 80
Power loss per unit (max.)	W	4.1 ... 6.3	6.2 ... 7.5	8 ... 14
Short-circuit protection				
• With fuse without contactor		See "Selection and ordering data" on pages 7/100 ... 7/102		
• With fuse and contactor		"Short-Circuit Protection with Fuses/Motor Starter Protectors for Motor Feeders", see Configuration Manual "Configuring SIRIUS Innovations – Selection Data for Fuseless and Fused Load Feeders" http://support.automation.siemens.com/WWW/view/en/50250599 .		
Protective separation between main and auxiliary current paths acc. to IEC 60947-1				
• Screw terminals or ring terminal lug connections	V	440	690: Setting ranges ≤ 25 A	690
• Spring-type terminals	V	440	440: Setting ranges > 25 A	690
Conductor cross-sections of main circuit				
Connection type		⊕ Screw terminals		
Terminal screw		M3, Pozidriv size 2	M4, Pozidriv size 2	M6, Pozidriv size 2
Operating devices	mm	∅ 5 ... 6	∅ 5 ... 6	∅ 5 ... 6
Prescribed tightening torque	Nm	0.8 ... 1.2	2 ... 2.5	3 ... 4.5
Conductor cross-sections (min./max.), 1 or 2 conductors can be connected				
• Solid or stranded	mm ²	2 x (0.5 ... 1.5) ¹⁾ , 2 x (0.75 ... 2.5) ¹⁾ , max. 2 x 4	2 x (1 ... 2.5) ¹⁾ , 2 x (2.5 ... 10) ¹⁾	2 x (2.5 ... 35) ¹⁾ , 1 x (2.5 ... 50) ¹⁾
• Finely stranded with end sleeve (DIN 46228-1)	mm ²	2 x (0.5 ... 1.5) ¹⁾ , 2 x (0.75 ... 2.5) ¹⁾	2 x (1 ... 2.5) ¹⁾ , 2 x (2.5 ... 6) ¹⁾ , max. 1 x 10	2 x (1 ... 25) ¹⁾ , 1 x (1 ... 35) ¹⁾
• AWG cables, solid or stranded	AWG	2 x (20 ... 16) ¹⁾ , 2 x (18 ... 14) ¹⁾ , 2 x 12	2 x (16 ... 12) ¹⁾ , 2 x (14 ... 8) ¹⁾	2 x (18 ... 2) ¹⁾ , 1 x (18 ... 1) ¹⁾
Connection type		⊙ Spring-type terminals		
Operating devices	mm	3.0 x 0.5 and 3.5 x 0.5		
Conductor cross-sections (min./max.), 1 conductor can be connected				
• Solid or stranded	mm ²	1 x (0.5 ... 4)	1 x (1 ... 10)	--
• Finely stranded without end sleeve	mm ²	1 x (0.5 ... 2.5)	1 x (1 ... 6)	--
• Finely stranded with end sleeve (DIN 46228-1)	mm ²	1 x (0.5 ... 2.5)	1 x (1 ... 6)	--
• AWG cables, solid or stranded	AWG	1 x (20 ... 12)	1 x (18 ... 8)	--
Connection type		⊕ Ring terminal lug connections		
Terminal screw		M3, Pozidriv size 2	M4, Pozidriv size 2	--
Operating devices	mm	∅ 5 ... 6	∅ 5 ... 6	--
Prescribed tightening torque	Nm	0.8 ... 1.2	2 ... 2.5	--
Usable ring terminal lugs				
• DIN 46234 without insulation sleeve	mm		$d_2 = \text{min. } 3.2,$ $d_3 = \text{max. } 7.5$	$d_2 = \text{min. } 4.3,$ $d_3 = \text{max. } 12.2$
• DIN 46225 without insulation sleeve				
• DIN 46237 with insulation sleeve				
• JIS C2805 Type R without insulation sleeve				
• JIS C2805 Type RAV with insulation sleeve				
• JIS C2805 Type RAP with insulation sleeve				

¹⁾ If two different conductor cross-sections are connected to one clamping point, both cross-sections must be in the range specified.

Overload Relays

SIRIUS 3RU2 Thermal Overload Relays

3RU2 up to 80 A for standard applications

Type		3RU2116	3RU2126	3RU2136
Size		S00	S0	S2
Auxiliary circuit				
Number of NO contacts		1		
Number of NC contacts		1		
Auxiliary contacts – assignment		1 NO for the signal "tripped"; 1 NC for disconnecting the contactor		
Rated insulation voltage U_i (pollution degree 3)	V	690		
Rated impulse withstand voltage U_{imp}	kV	6		
Contact rating of the auxiliary contacts				
• NC, NO contact with alternating current AC-15, rated operational current I_e at U_e :				
- 24 V	A	3		
- 120 V	A	3		
- 125 V	A	3		
- 230 V	A	2		
- 400 V	A	1		
- 600 V	A	0.75		
- 690 V	A	0.75		
• NC contact, NO contact with direct current DC-13, rated operational current I_e at U_e :				
- 24 V	A	1		
- 110 V	A	0.22		
- 125 V	A	0.22		
- 220 V	A	0.11		
• Contact reliability (suitability for PLC control; 17 V, 5 mA)				
		Yes		
Short-circuit protection				
• With fuse				
- Operational class gG	A	6		
- Quick	A	10		
• With miniature circuit breaker (C characteristic)				
	A	6 (up to $I_k \leq 0.5$ kA; $U \leq 260$ V)		
Reliable operational voltage for protective separation between auxiliary current paths acc. to IEC 60947-1	V	440		
CSA, UL, UR rated data				
Auxiliary circuit – switching capacity		B600, R300		
Conductor cross-sections for auxiliary circuit				
Connection type				
 Screw terminals				
Terminal screw		M3, Pozidriv size 2		
Operating devices	mm	Ø 5 ... 6		
Prescribed tightening torque	Nm	0.8 ... 1.2		
Conductor cross-sections (min./max.), 1 or 2 conductors can be connected				
• Solid or stranded	mm ²	2 x (0.5 ... 1.5) ¹⁾ , 2 x (0.75 ... 2.5) ¹⁾		
• Finely stranded with end sleeve (DIN 46228-1)	mm ²	2 x (0.5 ... 1.5) ¹⁾ , 2 x (0.75 ... 2.5) ¹⁾		
• AWG cables, solid or stranded	AWG	2 x (20 ... 16) ¹⁾ , 2 x (18 ... 14) ¹⁾		
Connection type				
 Spring-type terminals				
Operating devices	mm	3.0 x 0.5 and 3.5 x 0.5		
Conductor cross-sections (min./max.), 1 or 2 conductors can be connected				
• Solid or stranded	mm ²	2 x (0.5 ... 2.5)		
• Finely stranded without end sleeve	mm ²	2 x (0.5 ... 2.5)		
• Finely stranded with end sleeve (DIN 46228-1)	mm ²	2 x (0.5 ... 1.5)		
• AWG cables, solid or stranded	AWG	2 x (20 ... 14)		
Connection type				
 Ring terminal lug connections				
Terminal screw		M3, Pozidriv size 2		
Operating devices	mm	Ø 5 ... 6		
Prescribed tightening torque	Nm	0.8 ... 1.2		
Usable ring terminal lugs	mm	$d_2 = \text{min. } 3.2$, $d_3 = \text{max. } 7.5$		
<ul style="list-style-type: none"> • DIN 46234 without insulation sleeve • DIN 46225 without insulation sleeve • DIN 46237 with insulation sleeve • JIS C2805 Type R without insulation sleeve • JIS C2805 Type RAV with insulation sleeve • JIS C2805 Type RAP with insulation sleeve 				

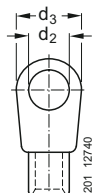

¹⁾ If two different conductor cross-sections are connected to one clamping point, both cross-sections must be in the range specified.

Overload Relays

SIRIUS 3RU2 Thermal Overload Relays

3RU2 up to 80 A for standard applications

Selection and ordering data

3RU21 thermal overload relays for mounting onto contactor¹⁾, sizes S00 and S0, CLASS 10

Features and technical specifications:

- Connection method
Main and auxiliary circuit: Either screw terminals, spring-type terminals or ring terminal lug connections²⁾
- Overload and phase failure protection
- Auxiliary contacts 1 NO + 1 NC
- Manual and automatic RESET
- Switch position indicator

- TEST function
- STOP button
- Sealable covers (optional accessory)
- Terminal covers for devices with ring terminal lug connection (optional accessory)

PU (UNIT, SET, M) = 1
PS* = 1 unit
PG = 41F



3RU2116-4AB0



3RU2116-4AC0



3RU2126-4FB0



3RU2126-4AC0

Size	contactor	Trip class	Current setting value of the inverse-time delayed overload release	Short-circuit protection with fuse, type of coordination "2", operational class gG ³⁾	DT	Screw terminals	DT	Spring-type terminals	
		Class	A	A		Article No.	Price per PU	Article No.	Price per PU
Size S00									
S00	10	10	0.11 ... 0.16	0.5	▶	3RU2116-0AB0	B	3RU2116-0AC0	
	10	10	0.14 ... 0.2	1	▶	3RU2116-0BB0	B	3RU2116-0BC0	
	10	10	0.18 ... 0.25	1	▶	3RU2116-0CB0	B	3RU2116-0CC0	
	10	10	0.22 ... 0.32	1.6	▶	3RU2116-0DB0	B	3RU2116-0DC0	
	10	10	0.28 ... 0.4	2	▶	3RU2116-0EB0	B	3RU2116-0EC0	
	10	10	0.35 ... 0.5	2	▶	3RU2116-0FB0	B	3RU2116-0FC0	
	10	10	0.45 ... 0.63	2	▶	3RU2116-0GB0	B	3RU2116-0GC0	
	10	10	0.55 ... 0.8	4	▶	3RU2116-0HB0	B	3RU2116-0HC0	
	10	10	0.7 ... 1	4	▶	3RU2116-0JB0	B	3RU2116-0JC0	
	10	10	0.9 ... 1.25	4	▶	3RU2116-0KB0	B	3RU2116-0KC0	
	10	10	1.1 ... 1.6	6	▶	3RU2116-1AB0	B	3RU2116-1AC0	
	10	10	1.4 ... 2	6	▶	3RU2116-1BB0	B	3RU2116-1BC0	
	10	10	1.8 ... 2.5	10	▶	3RU2116-1CB0	B	3RU2116-1CC0	
	10	10	2.2 ... 3.2	10	▶	3RU2116-1DB0	B	3RU2116-1DC0	
	10	10	2.8 ... 4	16	▶	3RU2116-1EB0	B	3RU2116-1EC0	
	10	10	3.5 ... 5	20	▶	3RU2116-1FB0	B	3RU2116-1FC0	
	10	10	4.5 ... 6.3	20	▶	3RU2116-1GB0	B	3RU2116-1GC0	
	10	10	5.5 ... 8	25	▶	3RU2116-1HB0	B	3RU2116-1HC0	
	10	10	7 ... 10	35	▶	3RU2116-1JB0	B	3RU2116-1JC0	
	10	10	9 ... 12.5	35	▶	3RU2116-1KB0	B	3RU2116-1KC0	
10	10	11 ... 16	40	▶	3RU2116-4AB0	B	3RU2116-4AC0		
Size S0									
S0	10	10	1.8 ... 2.5	10	▶	3RU2126-1CB0	B	3RU2126-1CC0	
	10	10	2.2 ... 3.2	10	▶	3RU2126-1DB0	B	3RU2126-1DC0	
	10	10	2.8 ... 4	16	▶	3RU2126-1EB0	B	3RU2126-1EC0	
	10	10	3.5 ... 5	20	▶	3RU2126-1FB0	B	3RU2126-1FC0	
	10	10	4.5 ... 6.3	20	▶	3RU2126-1GB0	B	3RU2126-1GC0	
	10	10	5.5 ... 8	25	▶	3RU2126-1HB0	B	3RU2126-1HC0	
	10	10	7 ... 10	35	▶	3RU2126-1JB0	B	3RU2126-1JC0	
	10	10	9 ... 12.5	35	▶	3RU2126-1KB0	B	3RU2126-1KC0	
	10	10	11 ... 16	40	▶	3RU2126-4AB0	▶	3RU2126-4AC0	
	10	10	14 ... 20	50	▶	3RU2126-4BB0	▶	3RU2126-4BC0	
	10	10	17 ... 22	63	▶	3RU2126-4CB0	▶	3RU2126-4CC0	
	10	10	20 ... 25	63	▶	3RU2126-4DB0	▶	3RU2126-4DC0	
	10	10	23 ... 28	63	▶	3RU2126-4NB0	▶	3RU2126-4NC0	
	10	10	27 ... 32	80	▶	3RU2126-4EB0	▶	3RU2126-4EC0	
	10	10	30 ... 36	80	▶	3RU2126-4PB0	▶	3RU2126-4PC0	
	10	10	34 ... 40	80	▶	3RU2126-4FB0	▶	3RU2126-4FC0	

¹⁾ With the suitable terminal supports (see "Accessories", page 7/103), the 3RU2 overload relays for mounting on contactors can also be installed as stand-alone units.

²⁾ When ordering the ring terminal lug version, the Article No. must be changed in the 10th digit to "J": e.g. 3RU2116-0AJ0.

³⁾ Maximum protection by fuse only for overload relay, type of coordination "2". Fuse values in connection with contactors, see Configuration Manual "Configuring SIRIUS Innovations – Selection Data for Fuseless and Fused Load Feeders", <http://support.automation.siemens.com/WW/view/en/50250599>.

Overload relays in size S2, see page 7/101.

Overload Relays

SIRIUS 3RU2 Thermal Overload Relays

3RU2 up to 80 A for standard applications

3RU21 thermal overload relays for mounting onto contactor¹⁾, size S2, CLASS 10

Features and technical specifications:

- Connection methods
 - Main circuit: Screw terminals with box terminal
 - Auxiliary circuit: Either screw or spring-type terminals
- Overload and phase failure protection
- Auxiliary contacts 1 NO + 1 NC
- Manual and automatic RESET
- Switch position indicator
- TEST function
- STOP button
- Sealable covers (optional accessory)

PU (UNIT, SET, M) = 1
 PS* = 1 unit
 PG = 41F



3RU2136-4.B0



3RU2136-4.D0

Size contactor	Trip class	Current setting value of the inverse-time delayed overload release	Short-circuit protection with fuse, type of coordination "2", operational class gG ²⁾	DT	Screw terminals		Spring-type terminals (on auxiliary current side)	
					Article No.	Price per PU	Article No.	Price per PU
Size S2								
S2	10	11 ... 16	40	NEW ▶	3RU2136-4AB0	X	3RU2136-4AD0	
	10	14 ... 20	50	NEW ▶	3RU2136-4BB0	X	3RU2136-4BD0	
	10	18 ... 25	63	NEW ▶	3RU2136-4DB0	X	3RU2136-4DD0	
	10	22 ... 32	80	NEW ▶	3RU2136-4EB0	X	3RU2136-4ED0	
	10	28 ... 40	80	NEW ▶	3RU2136-4FB0	X	3RU2136-4FD0	
	10	36 ... 45	100	NEW ▶	3RU2136-4GB0	X	3RU2136-4GD0	
	10	40 ... 50	100	NEW ▶	3RU2136-4HB0	X	3RU2136-4HD0	
	10	47 ... 57	100	NEW ▶	3RU2136-4QB0	X	3RU2136-4QD0	
	10	54 ... 65	125	NEW ▶	3RU2136-4JB0	X	3RU2136-4JD0	
	10A	62 ... 73	160	NEW ▶	3RU2136-4KB0	X	3RU2136-4KD0	
	10A	70 ... 80	160	NEW ▶	3RU2136-4RB0	X	3RU2136-4RD0	

¹⁾ With the suitable terminal supports (see "Accessories", page 7/103), the 3RU2 overload relays for mounting on contactors can also be installed as stand-alone units.

²⁾ Maximum protection by fuse only for overload relay, type of coordination "2".
 Fuse values in connection with contactors, see Configuration Manual "Configuring SIRIUS Innovations – Selection Data for Fuseless and Fused Load Feeders", <http://support.automation.siemens.com/WW/view/en/50250599>.

Overload Relays

SIRIUS 3RU2 Thermal Overload Relays

3RU2 up to 80 A for standard applications

3RU21 thermal overload relays for stand-alone installation, sizes S00 to S2, CLASS 10

Features and technical specifications:

- Connection methods
 - Sizes S00 and S0: Main and auxiliary circuit: Either screw or spring-type terminals
 - Size S2: Main circuit: Screw terminals with box terminal, main circuit: Either screw or spring-type terminals
- Auxiliary contacts 1 NO + 1 NC
- Manual and automatic RESET
- Switch position indicator
- TEST function
- STOP button
- Sealable covers (optional accessory)

PU (UNIT, SET, M) = 1
PS* = 1 unit
PG = 41F



3RU2116-4AC1



3RU2136-4.B1





3RU2126-4FB1



3RU2126-4FC1



3RU2136-4.D1

Size contactor	Trip class	Current setting value of the inverse-time delayed overload release		Short-circuit protection with fuse, type of coordination "2", operational class gG ²⁾	DT	Screw terminals 		DT	Spring-type terminals 			
		Class	A			A	Article No.		Price per PU	Article No.	Price per PU	
Size S00												
S00	10	0.11 ... 0.16	0.5	B	B	3RU2116-0AB1	B	3RU2116-0AC1	B	3RU2116-0BC1		
	10	0.14 ... 0.2	1	B	B	3RU2116-0BB1	B	3RU2116-0CC1	B	3RU2116-0CC1		
	10	0.18 ... 0.25	1	B	B	3RU2116-0CB1	B	3RU2116-0CC1	B	3RU2116-0CC1		
	10	0.22 ... 0.32	1.6	B	B	3RU2116-0DB1	B	3RU2116-0DC1	B	3RU2116-0DC1		
	10	0.28 ... 0.4	2	B	B	3RU2116-0EB1	B	3RU2116-0EC1	B	3RU2116-0EC1		
	10	0.35 ... 0.5	2	B	B	3RU2116-0FB1	B	3RU2116-0FC1	B	3RU2116-0FC1		
	10	0.45 ... 0.63	2	B	B	3RU2116-0GB1	B	3RU2116-0GC1	B	3RU2116-0GC1		
	10	0.55 ... 0.8	4	B	B	3RU2116-0HB1	B	3RU2116-0HC1	B	3RU2116-0HC1		
	10	0.7 ... 1	4	B	B	3RU2116-0JB1	B	3RU2116-0JC1	B	3RU2116-0JC1		
	10	0.9 ... 1.25	4	B	B	3RU2116-0KB1	B	3RU2116-0KC1	B	3RU2116-0KC1		
	10	1.1 ... 1.6	6	B	B	3RU2116-1AB1	B	3RU2116-1AC1	B	3RU2116-1AC1		
	10	1.4 ... 2	6	B	B	3RU2116-1BB1	B	3RU2116-1BC1	B	3RU2116-1BC1		
	10	1.8 ... 2.5	10	B	B	3RU2116-1CB1	B	3RU2116-1CC1	B	3RU2116-1CC1		
	10	2.2 ... 3.2	10	B	B	3RU2116-1DB1	B	3RU2116-1DC1	B	3RU2116-1DC1		
	10	2.8 ... 4	16	B	B	3RU2116-1EB1	B	3RU2116-1EC1	B	3RU2116-1EC1		
	10	3.5 ... 5	20	B	B	3RU2116-1FB1	B	3RU2116-1FC1	B	3RU2116-1FC1		
	10	4.5 ... 6.3	20	B	B	3RU2116-1GB1	B	3RU2116-1GC1	B	3RU2116-1GC1		
	10	5.5 ... 8	25	B	B	3RU2116-1HB1	B	3RU2116-1HC1	B	3RU2116-1HC1		
	10	7 ... 10	35	B	B	3RU2116-1JB1	B	3RU2116-1JC1	B	3RU2116-1JC1		
	10	9 ... 12.5	35	B	B	3RU2116-1KB1	B	3RU2116-1KC1	B	3RU2116-1KC1		
10	11 ... 16	40	B	B	3RU2116-4AB1	B	3RU2116-4AC1	B	3RU2116-4AC1			
Size S0												
S0	10	14 ... 20	50	B	B	3RU2126-4BB1	B	3RU2126-4BC1	B	3RU2126-4BC1		
	10	17 ... 22	63	B	B	3RU2126-4CB1	B	3RU2126-4CC1	B	3RU2126-4CC1		
	10	20 ... 25	63	B	B	3RU2126-4DB1	B	3RU2126-4DC1	B	3RU2126-4DC1		
	10	23 ... 28	63	B	B	3RU2126-4NB1	B	3RU2126-4NC1	B	3RU2126-4NC1		
	10	27 ... 32	80	B	B	3RU2126-4EB1	B	3RU2126-4EC1	B	3RU2126-4EC1		
	10	30 ... 36	80	B	B	3RU2126-4PB1	B	3RU2126-4PC1	B	3RU2126-4PC1		
	10	34 ... 40	80	B	B	3RU2126-4FB1	B	3RU2126-4FC1	B	3RU2126-4FC1		
	Size S2											
	S2	10	22 ... 32	80	NEW ▶	▶	3RU2136-4EB1	▶	3RU2136-4ED1	▶	3RU2136-4ED1	
		10	28 ... 40	80	NEW ▶	▶	3RU2136-4FB1	▶	3RU2136-4FD1	▶	3RU2136-4FD1	
10		36 ... 45	100	NEW ▶	▶	3RU2136-4GB1	▶	3RU2136-4GD1	▶	3RU2136-4GD1		
10		40 ... 50	100	NEW ▶	▶	3RU2136-4HB1	▶	3RU2136-4HD1	▶	3RU2136-4HD1		
10		47 ... 57	100	NEW ▶	▶	3RU2136-4QB1	▶	3RU2136-4QD1	▶	3RU2136-4QD1		
10		54 ... 65	125	NEW ▶	▶	3RU2136-4JB1	▶	3RU2136-4JD1	▶	3RU2136-4JD1		
10A		62 ... 73	160	NEW ▶	▶	3RU2136-4KB1	▶	3RU2136-4KD1	▶	3RU2136-4KD1		
10A		70 ... 80	160	NEW ▶	▶	3RU2136-4RB1	▶	3RU2136-4RD1	▶	3RU2136-4RD1		

¹⁾ Guide value for 4-pole standard motors at 50 Hz 400 V AC. The actual starting and rated data of the motor to be protected must be considered when selecting the units.

²⁾ Maximum protection by fuse only for overload relay, type of coordination "2". Fuse values in connection with contactors, see Configuration Manual "Configuring SIRIUS Innovations – Selection Data for Fuseless and Fused Load Feeders", <http://support.automation.siemens.com/WW/view/en/50250599>.









Overview

Overload relays for standard applications

The following optional accessories are available for the 3RU21 thermal overload relays:

- Size-specific terminal support for stand-alone installation, in sizes S00 and S0 also with spring-type terminals
- Mechanical RESET (for all sizes)
- Cable release for resetting devices which are difficult to access (for all sizes)
- Electrical remote RESET module in three voltage variants (for all sizes)
- Sealable cover (for all sizes)
- Terminal covers for devices with screw terminals (box terminals) and ring terminal lug connections

Selection and ordering data

Version	Size	DT	Article No.	Price per PU	PU (UNIT, SET, M)	PS*	PG
Terminal supports for stand-alone installation							
 3RU2916-3AA01	Terminal supports for overload relays with screw terminals		Screw terminals 				
		S00	▶	3RU2916-3AA01		1	1 unit 41F
		S0	▶	3RU2926-3AA01		1	1 unit 41F
		S2	NEW ▶	3RU2936-3AA01		1	1 unit 41F
 3RU2926-3AA01	Terminal supports for overload relays with spring-type terminals		Spring-type terminals 				
		S00	B	3RU2916-3AC01		1	1 unit 41F
 3RU2936-3AA01		S0	B	3RU2926-3AC01		1	1 unit 41F
	 3RU2916-3AC01						
 3RU2926-3AC01							
	Mechanical RESET						
 3RU2900-1A with pushbutton and extension plunger	Resetting plungers, holders and formers		S00 ... S2 ▶	3RU2900-1A		1	1 unit 41F
	Pushbuttons with extended stroke (12 mm), IP65, ∅ 22 mm		S00 ... S2 B	3SB3000-0EA11		1	1 unit 41J
	Extension plungers For compensation of the distance between the pushbutton and the unlatching button of the relay		S00 ... S2 A	3SX1335		1	1 unit 41J

Overload Relays

SIRIUS 3RU2 Thermal Overload Relays

Accessories

Version	Size	DT	Article No.	Price per PU	PU (UNIT, SET, M)	PS*	PG
Cable releases with holder for RESET							
 <p>3RU2900-1.</p>	For \varnothing 6.5 mm holes in the control panel; max. control panel thickness 8 mm						
	<ul style="list-style-type: none"> Length 400 mm Length 600 mm 	S00 ... S2 ▶ S00 ... S2 ▶	3RU2900-1B 3RU2900-1C		1 1	1 unit 1 unit	41F 41F
Modules for remote RESET, electrical							
 <p>3RU1900-2A.71</p>	Operating range 0.85 ... 1.1 \times U_N , power consumption AC 80 VA, DC 70 W, ON period 0.2 ... 4 s, switching frequency 60/h						
	<ul style="list-style-type: none"> 24 ... 30 V AC/DC 110 ... 127 V AC/DC 220 ... 250 V AC/DC 	S00 ... S2 A S00 ... S2 A S00 ... S2 A	3RU1900-2AB71 3RU1900-2AF71 3RU1900-2AM71		1 1 1	1 unit 1 unit 1 unit	41F 41F 41F
	Sealable covers						
 <p>3RV2908-0P</p>	For covering the setting knobs		S00 ... S2 ▶	3RV2908-0P	100	10 units	41E
Terminal covers							
 <p>3RT2936-4EA2</p>	Covers for devices with screw terminals (box terminals) Additional touch protection for fastening to the box terminals			Screw terminals 			
	<ul style="list-style-type: none"> Main current level 	S2 NEW B	3RT2936-4EA2		1	1 unit	41B
 <p>3RU2916-3BJ21</p>  <p>3RU2926-3BJ21</p>  <p>3RU2916-3BJ20</p>  <p>3RV2928-4AA00</p>  <p>3RT2916-4EA13</p>	Covers for devices with ring terminal lug connection (ensure finger-safety)			Ring terminal lug connection 			
	<ul style="list-style-type: none"> Main current level - Cover between contactor and overload relay for direct mounting of the overload relay - Cover for overload relay on load side 	S00 C S0 C S00 C S0 B S00, S0 B	3RU2916-3BJ21 3RU2926-3BJ21 3RU2916-3BJ20 3RV2928-4AA00 3RT2916-4EA13		1 1 1 1 1	10 units 10 units 10 units 1 unit 10 units	41F 41F 41F 41E 41B
	Auxiliary current level						

General accessories

Version	Size	Color	For overload relays	DT	Article No.	Price per PU	PU (UNIT, SET, M)	PS*	PG
---------	------	-------	---------------------	----	-------------	--------------	-------------------	-----	----

Tools for opening spring-type terminals



3RA2908-1A

Screwdrivers

For all SIRIUS devices with spring-type terminals

Length approx. 200 mm, 3.0 mm x 0.5 mm

Titanium gray/black, partially insulated

Main and auxiliary circuit connection: 3RU2

A

Spring-type terminals



3RA2908-1A

1

1 unit

41B

Blank labels

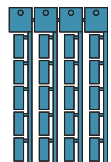

3RT1900-1SB20

Unit labeling plates¹⁾ for SIRIUS devices

20 mm x 7 mm

Pastel turquoise

3RU2

D

3RT1900-1SB20

100

340 units

41B

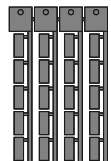

3RT2900-1SB20

20 mm x 7 mm

Titanium gray

3RU2

D

3RT2900-1SB20

100

340 units

41B

¹⁾ PC labeling system for individual inscription of unit labeling plates available from: murrplastik Systemtechnik GmbH (see Chapter 16, "Appendix" → "External Partners").

More information

Manuals

- System Manual "SIRIUS Innovations – System Overview" <http://support.automation.siemens.com/WW/view/en/60311318>
- Manual "SIRIUS Innovations – SIRIUS 3RU2/3RB3 Overload Relays" <http://support.automation.siemens.com/WW/view/en/60298164>

Overload Relays

SIRIUS 3RU1 Thermal Overload Relays

3RU11 up to 100 A for standard applications

Overview

Note:

The 3RU11 devices (sizes S00/S0 to S3) can be found

- in the Catalog Add-On IC 10 AO · 2015 at the Information and Download Center
- in the interactive catalog CA 01
- in the Industry Mall

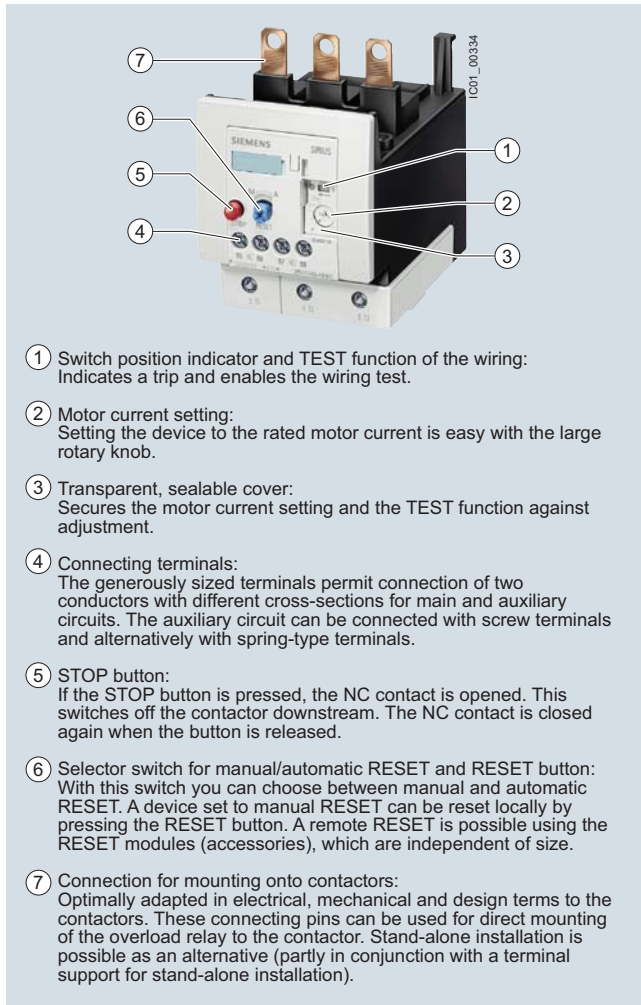

- ① Switch position indicator and TEST function of the wiring: Indicates a trip and enables the wiring test.
- ② Motor current setting: Setting the device to the rated motor current is easy with the large rotary knob.
- ③ Transparent, sealable cover: Secures the motor current setting and the TEST function against adjustment.
- ④ Connecting terminals: The generously sized terminals permit connection of two conductors with different cross-sections for main and auxiliary circuits. The auxiliary circuit can be connected with screw terminals and alternatively with spring-type terminals.
- ⑤ STOP button: If the STOP button is pressed, the NC contact is opened. This switches off the contactor downstream. The NC contact is closed again when the button is released.
- ⑥ Selector switch for manual/automatic RESET and RESET button: With this switch you can choose between manual and automatic RESET. A device set to manual RESET can be reset locally by pressing the RESET button. A remote RESET is possible using the RESET modules (accessories), which are independent of size.
- ⑦ Connection for mounting onto contactors: Optimally adapted in electrical, mechanical and design terms to the contactors. These connecting pins can be used for direct mounting of the overload relay to the contactor. Stand-alone installation is possible as an alternative (partly in conjunction with a terminal support for stand-alone installation).

The 3RU11 thermal overload relays up to 100 A have been designed for inverse-time delayed protection of loads with normal starting ("Function", see Reference Manual "Protection Equipment – 3RU1, 3RB2 Overload Relays", <http://support.automation.siemens.com/WW/view/en/35681830>) against excessive temperature rises due to overload or phase failure.

An overload or phase failure results in an increase of the motor current beyond the set rated motor current. Via heating elements, this current rise heats up the bimetal strips inside the device which then bend and as a result trigger the auxiliary contacts by means of a tripping mechanism. The auxiliary contacts then switch off the load by means of a contactor. The break time depends on the ratio between the tripping current and current setting I_e and is stored in the form of a long-term stable tripping characteristic (see "Characteristic Curves" <http://support.automation.siemens.com/WW/view/en/20356133/134300>).

The "tripped" status is signaled by means of a switch position indicator. Resetting takes place either manually or automatically after a recovery time has elapsed ("Function", see Reference Manual "Protection Equipment – 3RU1, 3RB2 Overload Relays" <http://support.automation.siemens.com/WW/view/en/35681830>).

The 3RU11 thermal overload relays are suitable for operation with frequency converters. Please follow the instructions in the Reference Manual "Protection Equipment – 3RU1, 3RB2 Overload Relays", see <http://support.automation.siemens.com/WW/view/en/35681830>.

The devices are manufactured in accordance with environmental guidelines and contain environmentally friendly and reusable materials.

They comply with all important worldwide standards and approvals.

3RU21 overload relays in sizes S00 to S2, see page 7/100 onwards.

Use in hazardous areas

The 3RU11 thermal overload relays are suitable for the protection of motors with "Flameproof enclosure d" or "Increased safety e" types of protection.

EC type test certificate for Category (2) G/D exists. It has the number DMT 98 ATEX G001.

SIRIUS 3RU1146-1HB0 thermal overload relay

Article No. scheme

Digit of the Article No.	1st - 3rd	4th	5th	6th	7th	8th	9th	10th	11th	
	□□□	□	□	□	□	-	□	□	□	
Thermal overload relays	3 R U									
SIRIUS 1st generation	1									
Device series	□									
Size, rated operational current and power	□ □									
Setting range of the overload release	□ □									
Connection methods	□									
Installation type	□									
Example	3 R U	1	1	4	6	-	4	D	B	0

Note:

The Article No. scheme is presented here merely for information purposes and for better understanding of the logic behind the article numbers.

For your orders, please use the article numbers quoted in the catalog in the Selection and ordering data.

Benefits

The most important features and benefits of the 3RU11 thermal overload relays are listed in the overview table (see "General Data", page 7/87 onwards).

Application

Industries

The 3RU11 thermal overload relays are suitable for customers from all industries who want to guarantee optimum inverse-time delayed protection of their electrical loads (e.g. motors) under normal starting conditions (CLASS 10).

Application

The 3RU11 thermal overload relays have been designed for the protection of three-phase and single-phase AC and DC motors.

If single-phase AC or DC loads are to be protected by the 3RU11 thermal overload relays, all three bimetal strips must be heated. For this purpose, all main current paths of the relay must be connected in series.



Ambient conditions

The 3RU11 thermal overload relays have temperature compensation in accordance with IEC 60947-4-1 for the temperature range of -20 to +60 °C. For temperatures from +60 to +70 °C, the upper set value of the setting range must be reduced by the factor listed in the table below.

Technical specifications

The following technical information is intended to provide an initial overview of the various types of device and functions.

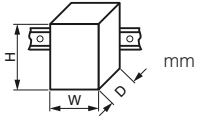
Detailed information, see
Reference Manual "Protection Equipment – 3RU1, 3RB2 Overload Relays",
<http://support.automation.siemens.com/WW/view/en/35681830>

Type Size Dimensions (W x H x D) (overload relay with stand-alone installation support)		3RU1146 S3 70 x 120 x 140 mm
General data		
Trips in the event of	Overload and phase failure	
Trip class acc. to IEC 60947-4-1	CLASS	10
Phase failure sensitivity	Yes	
Overload warning	No	
Reset and recovery	Manual, Automatic and Remote RESET (Remote RESET in combination with the corresponding accessories)	
<ul style="list-style-type: none"> Reset options after tripping 		
<ul style="list-style-type: none"> Recovery time <ul style="list-style-type: none"> - For automatic RESET - For manual RESET - For remote RESET 	min. min. min.	Depends on the strength of the tripping current and characteristic Depends on the strength of the tripping current and characteristic Depends on the strength of the tripping current and characteristic
Features	<ul style="list-style-type: none"> Display of operating state on device TEST function RESET button STOP button 	
<ul style="list-style-type: none"> Display of operating state on device 	Yes, by means of TEST function/switch position indicator slide	
<ul style="list-style-type: none"> TEST function 	Yes	
<ul style="list-style-type: none"> RESET button 	Yes	
<ul style="list-style-type: none"> STOP button 	Yes	
Protection and operation of motors with "Increased safety e" and "Flameproof enclosure d" types of protection	DMT 98 ATEX G 001  II (2) GD, see http://support.automation.siemens.com/WW/view/en/5355912	
EC type test certificate number according to directive 94/9/EC (ATEX)		
Ambient temperature	<ul style="list-style-type: none"> Storage/transport Operation Temperature compensation Permissible rated current at <ul style="list-style-type: none"> - Temperature inside control cabinet 60 °C - Temperature inside control cabinet 70 °C 	
<ul style="list-style-type: none"> Storage/transport 	°C	-55 ... +80
<ul style="list-style-type: none"> Operation 	°C	-20 ... +70
<ul style="list-style-type: none"> Temperature compensation 	°C	up to 60
<ul style="list-style-type: none"> Permissible rated current at <ul style="list-style-type: none"> - Temperature inside control cabinet 60 °C - Temperature inside control cabinet 70 °C 	%	100 (over +60 °C current reduction is not required)
<ul style="list-style-type: none"> - Temperature inside control cabinet 70 °C 	%	87
Repeat terminals	<ul style="list-style-type: none"> Coil repeat terminals Auxiliary contact repeat terminal 	
<ul style="list-style-type: none"> Coil repeat terminals 	Not required	
<ul style="list-style-type: none"> Auxiliary contact repeat terminal 	Not required	

Overload Relays

SIRIUS 3RU1 Thermal Overload Relays

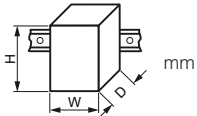
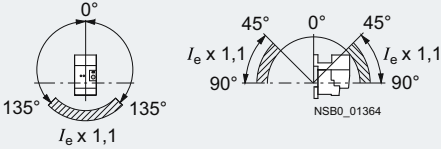
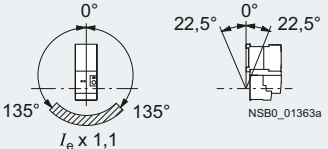

3RU11 up to 100 A for standard applications

Type Size Dimensions (W x H x D) (overload relay with stand-alone installation support)		3RU1146 S3 70 x 120 x 140 mm
General data (continued)		
Degree of protection acc. to IEC 60529	IP20 (terminal compartment: IP00 degree of protection)	
Touch protection acc. to IEC 61140	Finger-safe for vertical contact from the front	
Shock resistance with sine acc. to IEC 60068-2-27	g/ms	8/10
Electromagnetic compatibility (EMC)		
<ul style="list-style-type: none"> • Interference immunity • Emitted interference 	Not relevant	
Resistance to extreme climates – air humidity	%	100
Dimensions "Dimensional drawings", see Reference Manual "Protection Equipment – 3RU1, 3RB2 Overload Relays" , http://support.automation.siemens.com/WW/view/en/35681830		
Installation altitude above sea level	m	Up to 2 000; above this on request
Mounting position The diagrams show the permissible mounting positions for mounting onto contactors and stand-alone installation. For mounting position in the hatched area, a setting correction of 10 % must be implemented. Stand-alone installation:  Contactor + overload relay: 		
Type of mounting Direct mounting/stand-alone installation with terminal support (For screw and snap-on mounting onto TH 35 standard mounting rail; size S3 also for TH 75 standard mounting rail. For technical specifications of the terminal supports, see Reference Manual "Protection Equipment – 3RU1, 3RB2 Overload Relays" , http://support.automation.siemens.com/WW/view/en/35681830 .)		

Overload Relays

SIRIUS 3RU1 Thermal Overload Relays

3RU11 up to 100 A for standard applications

Type	3RU1146	
Size	S3	
Main circuit		
Rated insulation voltage U_i (pollution degree 3)	V	1 000
Rated impulse withstand voltage U_{imp}	kV	8
Rated operational voltage U_e	V	1 000
Type of current		
• Direct current	Yes	
• Alternating current	Yes, frequency range up to 400 Hz	
Current setting	A	18 ... 25 up to 80 ... 100
Power loss per unit (max.)	W	10 ... 16.5
Short-circuit protection		
• With fuse without contactor	See "Selection and ordering data" on page 7/111	
• With fuse and contactor	See Reference Manual "Protection Equipment – 3RU1, 3RB2 Overload Relays", http://support.automation.siemens.com/WW/view/en/35681830 → "Technical Specifications" → "Short-circuit protection with fuses/motor starter protectors for motor feeders".	
Protective separation between main and auxiliary current paths acc. to IEC 60947-1	V	690
Conductor cross-section of the main circuit		
Connection type	 Screw terminals with box terminal	
Terminal screw	M8, 4 mm Allen screw	
Operating devices	mm	4 mm Allen screw
Prescribed tightening torque	Nm	4 ... 6
Conductor cross-sections (min./max.), 1 or 2 conductors can be connected		
• Solid	mm ²	2 x (2.5 ... 16)
• Finely stranded with end sleeve (DIN 46228-1)	mm ²	2 x (2.5 ... 35) ¹⁾ , 1 x (2.5 ... 50) ¹⁾
• Stranded	mm ²	2 x (10 ... 50) ¹⁾ , 1 x (10 ... 70) ¹⁾
• AWG cables, solid or stranded	AWG	2 x (10 ... 1/0) ¹⁾ , 1 x (10 ... 2/0) ¹⁾
• Ribbon cable conductors (Number x Width x Thickness)	mm	2 x (6 x 9 x 0.8)
Connection type	 Busbar connection²⁾	
Terminal screw	M6 x 20	
Prescribed tightening torque	Nm	4 ... 6
Conductor cross-sections (min./max.)		
• Finely stranded with cable lug	mm ²	2 x 70
• Stranded with cable lug	mm ²	3 x 70
• AWG cables, solid or stranded, with cable lug	AWG	2/0
• With connecting bars (max. width)	mm	12

¹⁾ If two different conductor cross-sections are connected to one clamping point, both cross-sections must be in the range specified.



²⁾ The box terminal is removable. Rail and cable lug connections are possible if the box terminal is removed.



Overload Relays

SIRIUS 3RU1 Thermal Overload Relays

3RU11 up to 100 A for standard applications

Type	3RU1146																																																										
Size	S3																																																										
Auxiliary circuit																																																											
Number of NO contacts	1																																																										
Number of NC contacts	1																																																										
Auxiliary contacts – assignment	1 NO for the signal "tripped"; 1 NC for disconnecting the contactor																																																										
Rated insulation voltage U_i (pollution degree 3)	V	690																																																									
Rated impulse withstand voltage U_{imp}	kV	6																																																									
Contact rating of the auxiliary contacts																																																											
<ul style="list-style-type: none"> NC contact with alternating current AC-14/AC-15, rated operational current I_e at U_e: <table border="0"> <tr><td>- 24 V</td><td>A</td><td>4</td></tr> <tr><td>- 120 V</td><td>A</td><td>4</td></tr> <tr><td>- 125 V</td><td>A</td><td>4</td></tr> <tr><td>- 230 V</td><td>A</td><td>3</td></tr> <tr><td>- 400 V</td><td>A</td><td>2</td></tr> <tr><td>- 600 V</td><td>A</td><td>0.6</td></tr> <tr><td>- 690 V</td><td>A</td><td>0.5</td></tr> </table> NO contact with alternating current AC-14/AC-15, rated operational current I_e at U_e: <table border="0"> <tr><td>- 24 V</td><td>A</td><td>3</td></tr> <tr><td>- 120 V</td><td>A</td><td>3</td></tr> <tr><td>- 125 V</td><td>A</td><td>3</td></tr> <tr><td>- 230 V</td><td>A</td><td>2</td></tr> <tr><td>- 400 V</td><td>A</td><td>1</td></tr> <tr><td>- 600 V</td><td>A</td><td>0.6</td></tr> <tr><td>- 690 V</td><td>A</td><td>0.5</td></tr> </table> NC contact, NO contact with direct current DC-13, rated operational current I_e at U_e: <table border="0"> <tr><td>- 24 V</td><td>A</td><td>1</td></tr> <tr><td>- 60 V</td><td>A</td><td>On request</td></tr> <tr><td>- 110 V</td><td>A</td><td>0.22</td></tr> <tr><td>- 125 V</td><td>A</td><td>0.22</td></tr> <tr><td>- 220 V</td><td>A</td><td>0.11</td></tr> </table> Conventional thermal current I_{th} Contact reliability (suitability for PLC control; 17 V, 5 mA) 			- 24 V	A	4	- 120 V	A	4	- 125 V	A	4	- 230 V	A	3	- 400 V	A	2	- 600 V	A	0.6	- 690 V	A	0.5	- 24 V	A	3	- 120 V	A	3	- 125 V	A	3	- 230 V	A	2	- 400 V	A	1	- 600 V	A	0.6	- 690 V	A	0.5	- 24 V	A	1	- 60 V	A	On request	- 110 V	A	0.22	- 125 V	A	0.22	- 220 V	A	0.11
- 24 V	A	4																																																									
- 120 V	A	4																																																									
- 125 V	A	4																																																									
- 230 V	A	3																																																									
- 400 V	A	2																																																									
- 600 V	A	0.6																																																									
- 690 V	A	0.5																																																									
- 24 V	A	3																																																									
- 120 V	A	3																																																									
- 125 V	A	3																																																									
- 230 V	A	2																																																									
- 400 V	A	1																																																									
- 600 V	A	0.6																																																									
- 690 V	A	0.5																																																									
- 24 V	A	1																																																									
- 60 V	A	On request																																																									
- 110 V	A	0.22																																																									
- 125 V	A	0.22																																																									
- 220 V	A	0.11																																																									
	A	6																																																									
		Yes																																																									
Short-circuit protection																																																											
<ul style="list-style-type: none"> With fuse <table border="0"> <tr><td>- Operational class gG</td><td>A</td><td>6</td></tr> <tr><td>- Quick</td><td>A</td><td>10</td></tr> </table> With miniature circuit breaker (C characteristic) 			- Operational class gG	A	6	- Quick	A	10																																																			
- Operational class gG	A	6																																																									
- Quick	A	10																																																									
	A	6 ¹⁾																																																									
Protective separation between auxiliary current paths acc. to IEC 60947-1	V	440																																																									
CSA, UL, UR rated data																																																											
Auxiliary circuit – switching capacity	B600, R300																																																										
Conductor cross-sections of the auxiliary circuit																																																											
Connection type	 Screw terminals																																																										
Terminal screw	M3, Pozidriv size 2																																																										
Operating devices	mm	∅ 5 ... 6																																																									
Prescribed tightening torque	Nm	0.8 ... 1.2																																																									
Conductor cross-sections (min./max.), 1 or 2 conductors can be connected																																																											
• Solid	mm ²	2 x (0.5 ... 1.5) ²⁾ , 2 x (0.75 ... 2.5) ²⁾																																																									
• Finely stranded without end sleeve	mm ²	--																																																									
• Finely stranded with end sleeve (DIN 46228-1)	mm ²	2 x (0.5 ... 1.5) ²⁾ , 2 x (0.75 ... 2.5) ²⁾																																																									
• Stranded	mm ²	2 x (0.5 ... 1.5) ²⁾ , 2 x (0.75 ... 2.5) ²⁾																																																									
• AWG cables, solid or stranded	AWG	2 x (18 ... 14)																																																									
Connection type	 Spring-type terminals																																																										
Operating devices	mm	3.0 x 0.5 and 3.5 x 0.5																																																									
Conductor cross-sections (min./max.), 1 or 2 conductors can be connected																																																											
• Solid or stranded	mm ²	2 x (0.5 ... 2.5)																																																									
• Finely stranded without end sleeve	mm ²	2 x (0.5 ... 2.5)																																																									
• Finely stranded with end sleeve (DIN 46228-1)	mm ²	2 x (0.5 ... 1.5)																																																									
• AWG cables, solid or stranded	AWG	2 x (20 ... 14)																																																									

1) Up to $I_k \leq 0.5$ kA; ≤ 260 V.

2) If two different conductor cross-sections are connected to one clamping point, both cross-sections must be in the range specified.

Overload Relays

SIRIUS 3RU1 Thermal Overload Relays



3RU11 up to 100 A for standard applications

Selection and ordering data

Features and technical specifications:

- Connection methods
 - Main circuit: Screw terminals
 - Auxiliary circuit: Either screw or spring-type terminals
- Tripping class CLASS 10
- Overload and phase failure protection
- Auxiliary contacts 1 NO + 1 NC
- Manual and automatic RESET
- Switch position indicator
- TEST function
- STOP button
- Integrated sealable cover

3RU11 thermal overload relays with screw terminals on the auxiliary current side, CLASS 10

Size contactor	Trip class	Current setting value of the inverse-time delayed overload release	Short-circuit protection with fuse, type of coordination "2", operational class gG ¹⁾	DT	Screw terminals (on auxiliary current side)	PU (UNIT, SET, M)	PS*	PG		
	CLASS	A	A		Article No.	Price per PU				
Size S3										
For mounting onto contactor²⁾										
	S3	10	18 ... 25	63	▶	3RU1146-4DB0	1	1 unit	41F	
		10	22 ... 32	80	▶	3RU1146-4EB0	1	1 unit	41F	
	3RU1146-..B0	▶	10	28 ... 40	80	▶	3RU1146-4FB0	1	1 unit	41F
			10	36 ... 50	125	▶	3RU1146-4HB0	1	1 unit	41F
			10	45 ... 63	125	▶	3RU1146-4JB0	1	1 unit	41F
			10	57 ... 75	160	▶	3RU1146-4KB0	1	1 unit	41F
▶	10	70 ... 90	160	▶	3RU1146-4LB0	1	1 unit	41F		
	10	80 ... 100 ³⁾	200	▶	3RU1146-4MB0	1	1 unit	41F		
For stand-alone installation										
	S3	10	45 ... 63	125	▶	3RU1146-4JB1	1	1 unit	41F	
		10	57 ... 75	160	▶	3RU1146-4KB1	1	1 unit	41F	
		10	70 ... 90	160	▶	3RU1146-4LB1	1	1 unit	41F	
		10	80 ... 100 ³⁾	200	▶	3RU1146-4MB1	1	1 unit	41F	

1) Maximum protection by fuse only for overload relay, type of coordination "2". Fuse values in connection with contactors, see Reference Manual "Protection Equipment – 3RU1, 3RB2 Overload Relays", <http://support.automation.siemens.com/WW/view/en/35681830> → "Technical Specifications" → "Short-Circuit Protection with Fuses/Motor Starter Protectors for Motor Feeders".

2) With the appropriate terminal supports (see "Accessories", page 7/112), the 3RU11 overload relays for mounting onto contactors can also be installed as stand-alone units.

3) For overload relays > 100 A, see 3RB2 electronic overload relays, page 7/130 onwards.

3RU11 thermal overload relays with screw terminals, CLASS 10

Size contactor	Trip class	Current setting value of the inverse-time delayed overload release	Short-circuit protection with fuse, type of coordination "2", operational class gG ¹⁾	DT	Spring-type terminals (on auxiliary current side)	PU (UNIT, SET, M)	PS*	PG		
	CLASS	A	A		Article No.	Price per PU				
Size S3²⁾										
For mounting onto contactor³⁾										
	S3	10	18 ... 25	63	B	3RU1146-4DD0	1	1 unit	41F	
		10	22 ... 32	80	B	3RU1146-4ED0	1	1 unit	41F	
	3RU1146-..D0	▶	10	28 ... 40	80	B	3RU1146-4FD0	1	1 unit	41F
			10	36 ... 50	125	B	3RU1146-4HD0	1	1 unit	41F
			10	45 ... 63	125	▶	3RU1146-4JD0	1	1 unit	41F
			10	57 ... 75	160	▶	3RU1146-4KD0	1	1 unit	41F
▶	10	70 ... 90	160	▶	3RU1146-4LD0	1	1 unit	41F		
	10	80 ... 100	200	▶	3RU1146-4MD0	1	1 unit	41F		

1) Maximum protection by fuse only for overload relay, type of coordination "2". Fuse values in connection with contactors, see Reference Manual "Protection Equipment – 3RU1, 3RB2 Overload Relays", <http://support.automation.siemens.com/WW/view/en/35681830> → "Technical Specifications" → "Short-Circuit Protection with Fuses/Motor Starter Protectors for Motor Feeders".

2) Auxiliary conductor connections with spring-type terminals and main conductor connections with screw terminals.

3) With the appropriate terminal supports (see "Accessories", page 7/112), the 3RU11 overload relays for mounting onto contactors can also be installed as stand-alone units.

Overload Relays

SIRIUS 3RU1 Thermal Overload Relays

Accessories

Overview

Overload relays for standard applications

The following optional accessories are available for the 3RU11 thermal overload relays:

- Terminal supports for stand-alone installation for the overload relays
- Mechanical RESET (for all sizes)
- Cable release for resetting devices which are difficult to access (for all sizes)
- Electrical remote RESET module in three voltage variants (for all sizes)
- Terminal covers



Technical specifications

Terminal supports for stand-alone installation

Type	3RU1946-3AA01		
For overload relays	3RU1146		
Mounting type	For screw and snap-on mounting onto TH 35 and TH 75 standard mounting rails		
Connection for main circuit			
Connection type	⊕ Screw terminals with box terminal		
Terminal screw	mm	4 mm Allen screw	
Operating devices	mm	4 mm Allen screw	
Prescribed tightening torque	Nm	4 ... 6	
Conductor cross-sections (min./max.) , 1 or 2 conductors can be connected			
• Solid or stranded	mm ²	2 x (2.5 ... 16)	
• Finely stranded without end sleeve	mm ²	--	
• Finely stranded with end sleeve (DIN 46228-1)	mm ²	2 x (2.5 ... 35) ¹⁾ , 1 x (2.5 ... 50) ¹⁾	
• Stranded	mm ²	2 x (10 ... 50) ¹⁾ , 1 x (10 ... 70) ¹⁾	
• AWG cables, solid or stranded	AWG	2 x (10 ... 1/0) ¹⁾ , 1 x (10 ... 2/0) ¹⁾	
• Ribbon cable conductors (Number x Width x Thickness)	mm	2 x (6 x 9 x 0.8)	

¹⁾ If two different conductor cross-sections are connected to one clamping point, both cross-sections must be in the range specified.

Selection and ordering data

Version	Size	DT	Article No.	Price per PU	PU (UNIT, SET, M)	PS*	PG
Terminal supports for stand-alone installation							
	For separate mounting of the overload relays; screw and snap-on mounting onto standard mounting rail	S3	▶	3RU1946-3AA01		1	1 unit 41F
Mechanical RESET							
	Resetting plungers, holders and formers	S3	▶	3RU1900-1A		1	1 unit 41F
	Pushbuttons with extended stroke (12 mm), IP65, ø 22 mm	S3	B	3SB3000-0EA11		1	1 unit 41J
	Extension plungers For compensation of the distance between the pushbutton and the unlatching button of the relay	S3	A	3SX1335		1	1 unit 41J

3RU19.6-3AA01

3RU1900-1A
with pushbutton and
extension plunger

Overload Relays

SIRIUS 3RU1 Thermal Overload Relays

Accessories

Version	Size	DT	Article No.	Price per PU	PU (UNIT, SET, M)	PS*	PG
---------	------	----	-------------	--------------	-------------------	-----	----

Cable releases with holder for RESET



3RU1900-1.

For \varnothing 6.5 mm holes in the control panel;
max. control panel thickness 8 mm

- Length 400 mm
- Length 600 mm

S3

**3RU1900-1B**

1

1 unit

41F

S3

**3RU1900-1C**

1

1 unit

41F

Modules for remote RESET, electrical



3RU1900-2A.71

Operating range 0.85 ... 1.1 \times U_{S1} ,
power consumption AC 80 VA, DC 70 W,
ON period 0.2 ... 4 s,
switching frequency 60/h

- 24 ... 30 V AC/DC
- 110 ... 127 V AC/DC
- 220 ... 250 V AC/DC

S3

A

3RU1900-2AB71

1

1 unit

41F

S3

A

3RU1900-2AF71

1

1 unit

41F

S3

A

3RU1900-2AM71

1

1 unit

41F

Terminal covers

Covers for cable lugs and busbar connections

- Length 55 mm

S3

B

3RT1946-4EA1

1

1 unit

41B

Covers for box terminals

- Length 20.8 mm

S3

**3RT1946-4EA2**

1

1 unit

41B

General accessories

Version	Size	Color	For overload relays	DT	Article No.	Price per PU	PU (UNIT, SET, M)	PS*	PG
---------	------	-------	---------------------	----	-------------	--------------	-------------------	-----	----

Tools for opening spring-type terminals



3RA2908-1A

Screwdrivers

For all SIRIUS devices
with spring-type
terminals

Length approx.
200 mm,
3.0 mm x 0.5 mm

Titanium
gray/
black,
partially
insulated

Main and
auxiliary
circuit
connection:
3RU1

A

Spring-type terminals

**3RA2908-1A**

1

1 unit

41B

Blank labels

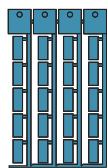

3RT1900-1SB20

Unit labeling plates¹⁾ for SIRIUS devices

20 mm x 7 mm

Pastel
turquoise

3RU1

D

3RT1900-1SB20

100

340 units

41B

20 mm x 7 mm

Titanium
gray

3RU1

D

3RT2900-1SB20

100

340 units

41B

Adhesive inscription labels¹⁾

19 mm x 6 mm

Pastel
turquoise

3RU1

C

3RT1900-1SB60

100

3 060 units

41B

for SIRIUS devices

19 mm x 6 mm

Zinc yellow

3RU1

C

3RT1900-1SD60

100

3 060 units

41B

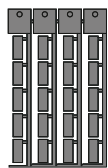

3RT2900-1SB20

¹⁾ PC labeling system for individual inscription
of unit labeling plates available from:
murrplastik Systemtechnik GmbH
(see Chapter 16, "Appendix" → "External Partners").

Overload Relays

SIRIUS 3RB3 Electronic Overload Relays

3RB30, 3RB31 up to 80 A for standard applications

Overview

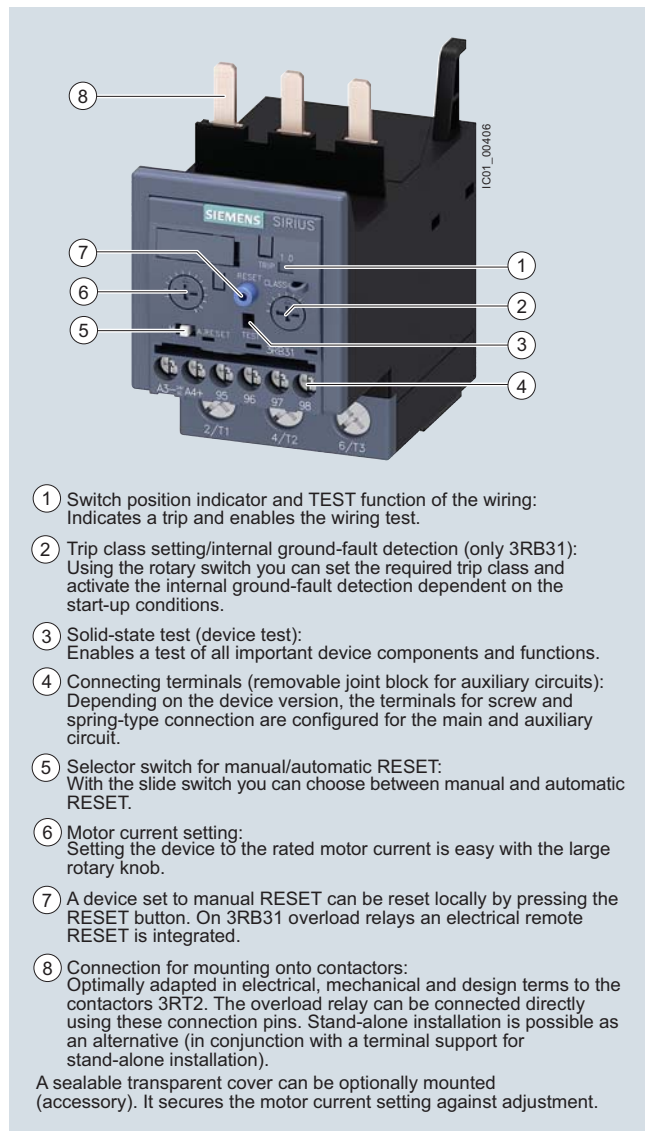

- ① Switch position indicator and TEST function of the wiring:
Indicates a trip and enables the wiring test.
- ② Trip class setting/internal ground-fault detection (only 3RB31):
Using the rotary switch you can set the required trip class and activate the internal ground-fault detection dependent on the start-up conditions.
- ③ Solid-state test (device test):
Enables a test of all important device components and functions.
- ④ Connecting terminals (removable joint block for auxiliary circuits):
Depending on the device version, the terminals for screw and spring-type connection are configured for the main and auxiliary circuit.
- ⑤ Selector switch for manual/automatic RESET:
With the slide switch you can choose between manual and automatic RESET.
- ⑥ Motor current setting:
Setting the device to the rated motor current is easy with the large rotary knob.
- ⑦ A device set to manual RESET can be reset locally by pressing the RESET button. On 3RB31 overload relays an electrical remote RESET is integrated.
- ⑧ Connection for mounting onto contactors:
Optimally adapted in electrical, mechanical and design terms to the contactors 3RT2. The overload relay can be connected directly using these connection pins. Stand-alone installation is possible as an alternative (in conjunction with a terminal support for stand-alone installation).

A sealable transparent cover can be optionally mounted (accessory). It secures the motor current setting against adjustment.

SIRIUS 3RU3133-4.B0 electronic overload relay

The 3RB30/3RB31 electronic overload relays up to 80 A with internal power supply have been designed for inverse-time delayed protection of loads with normal and heavy starting (for "Function", see the manual "SIRIUS Innovations – SIRIUS 3RU2/3RB3 Overload Relays", <http://support.automation.siemens.com/WW/view/en/60298164>) against excessive temperature rises due to overload, phase unbalance or phase failure. An overload, phase unbalance or phase failure result in an increase of the motor current beyond the set rated motor current. This current rise is detected by the current transformers integrated into the devices and evaluated by corresponding solid-state circuits which then output a pulse to the auxiliary contacts. The auxiliary contacts then switch off the load by means of a contactor. The break time depends on the ratio between the tripping current and current setting I_{ϕ} and is stored in the form of a long-term stable tripping characteristic (see "Characteristic Curves" <http://support.automation.siemens.com/WW/view/en/34290881/134300>).

In addition to inverse-time delayed protection of loads against excessive temperature rises due to overload, phase unbalance and phase failure, the 3RB31 electronic overload relays also allow internal ground-fault detection (not possible in conjunction with contactor assemblies for wye-delta starting). This provides protection of loads against high-resistance short circuits due to damage to the insulation material, moisture, condensed water etc.

The "tripped" status is signaled by means of a switch position indicator. Resetting takes place either manually or automatically after the recovery time has elapsed ("Function", see manual "SIRIUS Innovations – SIRIUS 3RU2/3RB3 Overload Relays", <http://support.automation.siemens.com/WW/view/en/60298164>).

The 3RB3 electronic overload relays are suitable for operation with frequency converters. Please follow the instructions in the manual "SIRIUS Innovations – 3RU2/3RB3 Overload Relays", see <http://support.automation.siemens.com/WW/view/en/60298164>.

The devices are manufactured in accordance with environmental guidelines and contain environmentally friendly and reusable materials. They comply with all important worldwide standards and approvals.

3RB20 and 3RB21 overload relays in sizes S2 to S10/S12, see page 7/130 onwards.

Use in hazardous areas

The 3RB30/3RB31 electronic overload relays are suitable for the overload protection of motors with the following types of protection:

- Ex II (2) G [Ex e] [Ex d] [Ex px]
- Ex II (2) D [Ex t] [Ex p]

EC type test certificate for Group II, Category (2) G/D exists. It has the number PTB 09 ATEX 3001.

Overload Relays

SIRIUS 3RB3 Electronic Overload Relays

3RB30, 3RB31 up to 80 A for standard applications

Article No. scheme

Digit of the Article No.	1st - 3rd	4th	5th	6th	7th	8th	9th	10th	11th
	□□□	□	□	□	□	-	□	□	□
Electronic overload relays	3 R B								
SIRIUS 3rd generation	3								
Device series			□						
Size, rated operational current and power				□					
Version of the automatic RESET, electrical remote RESET					□				
Trip class (CLASS)							□		
Setting range of the overload release								□	
Connection methods									□
Installation type									□
Example	3 R B	3	0	1	6	-	1	R	B 0

Note:

The Article No. scheme is presented here merely for information purposes and for better understanding of the logic behind the article numbers.

For your orders, please use the article numbers quoted in the catalog in the Selection and ordering data.

Benefits

The most important features and benefits of the 3RB30/3RB31 electronic overload relays are listed in the overview table (see "General Data" on page 7/87).

Advantages through energy efficiency

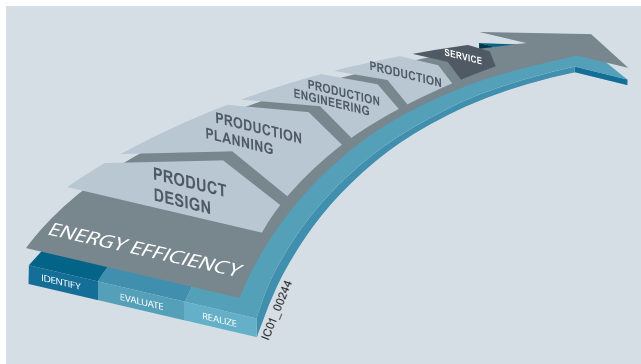

Overview of the energy management process

We offer you a unique portfolio for industrial energy management, using an energy management system that helps to optimally define your energy needs. We split up our industrial energy management into three phases – identify, evaluate and realize – and we support you with the appropriate hardware and software solutions in every process phase.

The innovative products of the SIRIUS industrial controls portfolio can also make a substantial contribution to a plant's energy efficiency (see www.siemens.com/sirius/energysaving).

3RB30/3RB31 electronic overload relays contribute to energy efficiency throughout the plant as follows:

- Reduced inherent power loss
- Less heating of the control cabinet
- Smaller control cabinet air conditioners can be used

Application

Industries

The 3RB30/3RB31 electronic overload relays are suitable for customers from all industries who want to guarantee optimum inverse-time delayed protection of their electrical loads (e.g. motors) under normal and heavy starting conditions (CLASS 5E to 30E), minimize project completion times, inventories and energy consumption, and optimize plant availability and maintenance management.

Application

The 3RB30/3RB31 electronic overload relays have been designed for the protection of three-phase motors in sinusoidal 50/60 Hz voltage networks. The relays are not suitable for the protection of single-phase AC or DC loads.

The 3RU21 thermal overload relay or the 3RB22/3RB23 solid-state overload relay can be used for single-phase AC loads. For DC loads we recommend the 3RU21 thermal overload relay.

Ambient conditions

The devices are insensitive to external influences such as shocks, corrosive ambient conditions, ageing and temperature fluctuations.

For the temperature range from -25 °C to +60 °C, the 3RB30/3RB31 electronic overload relays compensate the temperature in accordance with IEC 60947-4-1.

Overload Relays

SIRIUS 3RB3 Electronic Overload Relays

3RB30, 3RB31 up to 80 A for standard applications

Technical specifications

The following technical information is intended to provide an initial overview of the various types of device and functions.

Detailed information, see



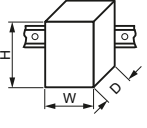

- Manual "SIRIUS Innovations – SIRIUS 3RU2/3RB3 Overload Relays", <http://support.automation.siemens.com/WWW/view/en/60298164>
- or specific information on a particular article number via the product data sheet, <http://support.automation.siemens.com/WWW/view/en/34290881/133200>

Type		3RB301., 3RB311.	3RB302., 3RB312.	3RB3036, 3RB3133
Size		S00	S0	S2
Dimensions (W x H x D) (overload relay with stand-alone installation support)				
• Screw terminals	mm	45 x 89 x 80	45 x 97 x 94	55 x 105 x 117
• Spring-type terminals	mm	45 x 102 x 80	45 x 116 x 95	55 x 105 x 117
General data				
Trips in the event of		Overload, phase failure, and phase unbalance + ground fault (for 3RB31 only)		
Trip class acc. to IEC 60947-4-1	CLASS	3RB30: 10E, 20E; 3RB31: 5E, 10E, 20E or 30E adjustable		
Phase failure sensitivity		Yes		
Reset and recovery		Manual and automatic RESET, 3RB31 has an integrated connection for electrical remote RESET (24 V DC)		
• Reset options after tripping		Manual and automatic RESET, 3RB31 has an integrated connection for electrical remote RESET (24 V DC)		
• Recovery time		Approx. 3 min		
- For automatic RESET		Immediately		
- For manual RESET		Immediately		
- For remote RESET		Immediately		
Features		Yes, by means of switch position indicator slide		
• Display of operating state on device		Yes, test of electronics by pressing the TEST button/ test of auxiliary contacts and wiring of control circuit by actuating the switch position indicator slide/self-monitoring		
• TEST function		Yes		
• RESET button		No		
• STOP button		No		
Protection and operation of explosion-proof motors		PTB 09 ATEX 3001 ⚠ II (2) G [Ex e] [Ex d] [Ex px] ⚠ II (2) G [Ex t] [Ex p] See http://support.automation.siemens.com/WWW/view/en/40591327		
EC type test certificate number according to directive 94/9/EC (ATEX)		On request		
Ambient temperatures				
• Storage/transport	°C	-40 ... +80		
• Operation	°C	-25 ... +60		
• Temperature compensation	°C	+60		
• Permissible rated current at				
- Temperature inside control cabinet 60 °C	%	100		
- Temperature inside control cabinet 70 °C	%	On request		
Repeat terminals				
• Coil repeat terminals		Yes	Not required	
• Auxiliary contact repeat terminal		Yes	Not required	
Degree of protection acc. to IEC 60529		IP20		
Touch protection acc. to IEC 61140		Finger-safe for vertical contact from the front		
Shock resistance with sine acc. to IEC 60068-2-27	g/ms	15/11 (signaling contact 97/98 in "Tripped" position: 9 g/11 ms)		15/11 (signaling contact 97/98 in "Tripped" position: 8 g/11 ms)
Electromagnetic compatibility (EMC) – Interference immunity				
• Conductor-related interference				
- Burst acc. to IEC 61000-4-4 (corresponds to degree of severity 3)	kV	2 (power ports), 1 (signal ports)		
- Surge acc. to IEC 61000-4-5 (corresponds to degree of severity 3)	kV	2 (line to earth), 1 (line to line)		
• Electrostatic discharge according to IEC 61000-4-2 (corresponds to degree of severity 3)	kV	8 (air discharge), 6 (contact discharge)		
• Field-related interference acc. to IEC 61000-4-3 (corresponds to degree of severity 3)	V/m	10		
Electromagnetic compatibility (EMC) – emitted interference		Degree of severity B acc. to EN 55011 (CISPR 11) and EN 55022 (CISPR 22)		
Resistance to extreme climates – air humidity	%	95		

Overload Relays

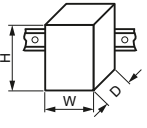
SIRIUS 3RB3 Electronic Overload Relays

3RB30, 3RB31 up to 80 A for standard applications



Type		3RB301., 3RB311.	3RB302., 3RB312.	3RB3036, 3RB3133
Size		S00	S0	S2
Dimensions (W x H x D) (overload relay with stand-alone installation support)				
• Screw terminals • Spring-type terminals	mm	45 x 89 x 80 45 x 102 x 80	45 x 97 x 94 45 x 116 x 95	55 x 105 x 117 55 x 105 x 117
General data (continued)				
Dimensions		"Dimensional drawings", see • Manual "SIRIUS Innovations – SIRIUS 3RU2/3RB3 Overload Relays", http://support.automation.siemens.com/WW/view/en/60298164 • Product data sheet, http://support.automation.siemens.com/WW/view/en/34290881/133200		
Installation altitude above sea level	m	Up to 2 000		
Mounting position		Any		
Type of mounting		Direct mounting/stand-alone installation with terminal support		
Type		3RB301., 3RB311.	3RB302., 3RB312.	3RB3036, 3RB3133
Size		S00	S0	S2
Main circuit				
Rated insulation voltage U_i (pollution degree 3)	V	690		
Rated impulse withstand voltage U_{imp}	kV	6		
Rated operational voltage U_e	V	690		
Type of current • Direct current • Alternating current		No Yes, 50/60 Hz \pm 5 %		
Current setting	A	0.1 ... 0.4 up to	0.1 ... 0.4 up to	12.5 ... 50 and
	A	4 ... 16	10 ... 40	20 to 80
Heavy starting		See Manual "SIRIUS Innovations – SIRIUS 3RU2/3RB3 Overload Relays", http://support.automation.siemens.com/WW/view/en/60298164		
Power loss per unit (max.)	W	0.05 ... 0.2		
Short-circuit protection • With fuse without contactor • With fuse and contactor		See "Selection and ordering data" on pages 7/119 to 7/121 "Short-Circuit Protection with Fuses/Motor Starter Protectors for Motor Feeders", see Configuration Manual for "Configuring SIRIUS Innovations – Selection Data for Fuseless and Fused Load Feeders", http://support.automation.siemens.com/WW/view/en/39714188 .		
Protective separation between main and auxiliary current paths acc. to IEC 60947-1 (pollution degree 2)				
• For systems with grounded neutral point	V	690		
• For systems with ungrounded neutral point	V	600		
Conductor cross-sections of main circuit				
Connection type		 Screw terminals		
Terminal screw		M3, Pozidriv size 2	M4, Pozidriv size 2	
Operating devices	mm	\varnothing 5 ... 6		
Prescribed tightening torque	Nm	0.8 ... 1.2		
Conductor cross-sections (min./max.), 1 or 2 conductors can be connected • Solid or stranded	mm ²	2 x (0.5 ... 1.5) ¹⁾ , 2 x (0.75 ... 2.5) ¹⁾ , 2 x (0.5 ... 4) ¹⁾	2 x (1 ... 2.5) ¹⁾ , 2 x (2.5 ... 10) ¹⁾	1 x (1 ... 50) ¹⁾ , 2 x (1 ... 35) ¹⁾
• Finely stranded with end sleeve (DIN 46228-1)	mm ²	2 x (0.5 ... 1.5) ¹⁾ , 2 x (0.75 ... 2.5) ¹⁾	2 x (1 ... 2.5) ¹⁾ , 2 x (2.5 ... 6) ¹⁾ , max. 1 x 10	2 x (1 ... 25) ¹⁾ , 1 x (1 ... 35) ¹⁾
• AWG cables, solid or stranded	AWG	2 x (20 ... 16) ¹⁾ , 2 x (18 ... 14) ¹⁾ , 2 x 12	2 x (16 ... 12) ¹⁾ , 2 x (14 ... 8) ¹⁾	2 x (18 ... 2) ¹⁾ , 1 x (18 ... 1) ¹⁾
Connection type		 Spring-type terminals		
Operating devices	mm	3.0 x 0.5 and 3.5 x 0.5		
Conductor cross-sections (min./max.), 1 conductor can be connected • Solid or stranded • Finely stranded without end sleeve • Finely stranded with end sleeve (DIN 46228-1) • AWG cables, solid or stranded	mm ²	1 x (0.5 ... 4)	1 x (1 ... 10)	--
	mm ²	1 x (0.5 ... 2.5)	1 x (1 ... 6)	--
	mm ²	1 x (0.5 ... 2.5)	1 x (1 ... 6)	--
	AWG	1 x (20 ... 12)	1 x (18 ... 8)	--
Connection type		 Straight-through transformers		
Diameter of opening	mm	--		15

¹⁾ If two different conductor cross-sections are connected to one clamping point, both cross-sections must be in the range specified.

Overload Relays

SIRIUS 3RB3 Electronic Overload Relays

3RB30, 3RB31 up to 80 A for standard applications

Type		3RB301., 3RB311.	3RB302., 3RB312.	3RB3036, 3RB3133
Size		S00	S0	S2
Auxiliary circuit				
Number of NO contacts		1		
Number of NC contacts		1		
Auxiliary contacts – assignment		1 NO for the signal "tripped"; 1 NC for disconnecting the contactor		
Rated insulation voltage U_i (pollution degree 3)	V	300		
Rated impulse withstand voltage U_{imp}	kV	4		
Auxiliary contacts – contact rating				
• NC contact with alternating current AC-14/AC-15, rated operational current I_e at U_e :				
- 24 V	A	4		
- 120 V	A	4		
- 125 V	A	4		
- 250 V	A	3		
• NO contact with alternating current AC-14/AC-15, rated operational current I_e at U_e :				
- 24 V	A	4		
- 120 V	A	4		
- 125 V	A	4		
- 250 V	A	3		
• NC contact, NO contact with direct current DC-13, rated operational current I_e at U_e :				
- 24 V	A	2		
- 60 V	A	0.55		
- 110 V	A	0.3		
- 125 V	A	0.3		
- 250 V	A	0.11		
• Conventional thermal current I_{th}	A	5		
• Contact reliability (suitability for PLC control; 17 V, 5 mA)		Yes		
Short-circuit protection				
• With fuse, operational class gG	A	6		
Ground-fault protection (only 3RB31)				
• Tripping value I_{Δ}		The information refers to sinusoidal residual currents at 50/60 Hz. > $0.75 \times I_{motor}$		
• Operating range I		Lower current setting value < I_{motor} < $3.5 \times$ upper current setting value		
• Response time t_{trip} (in steady-state condition)	s	< 1		
Integrated electrical remote RESET (only 3RB31)				
Connecting terminals A3, A4		24 V DC, max. 200 mA for approx. 20 ms, then < 10 mA		
Protective separation between auxiliary current paths acc. to IEC 60947-1	V	300		
CSA, UL, UR rated data				
Auxiliary circuit – switching capacity		3RB30: B600, R300; 3RB31: B300, R300		
Conductor cross-sections for auxiliary circuit				
Connection type		 Screw terminals		
Terminal screw		M3, Pozidriv size 2		
Operating devices	mm	ø 5 ... 6		
Prescribed tightening torque	Nm	0.8 ... 1.2		
Conductor cross-sections (min./max.), 1 or 2 conductors can be connected				
• Solid or stranded	mm ²	1 × (0.5 ... 4) ¹⁾ , 2 × (0.5 ... 2.5) ¹⁾		
• Finely stranded with end sleeve (DIN 46228-1)	mm ²	1 × (0.5 ... 2.5) ¹⁾ , 2 × (0.5 ... 1.5) ¹⁾		
• AWG cables, solid or stranded	AWG	2 × (20 ... 14)		
Connection type		 Spring-type terminals		
Operating devices	mm	3.0 × 0.5		
Conductor cross-sections (min./max.), 1 or 2 conductors can be connected				
• Solid or stranded	mm ²	2 × (0.25 ... 1.5)		
• Finely stranded without end sleeve	mm ²	2 × (0.25 ... 1.5)		
• Finely stranded with end sleeve (DIN 46228-1)	mm ²	2 × (0.25 ... 1.5)		
• AWG cables, solid or stranded	AWG	2 × (24 ... 16)		

¹⁾ If two different conductor cross-sections are connected to one clamping point, both cross-sections must be in the range specified.

Overload Relays

SIRIUS 3RB3 Electronic Overload Relays

3RB30, 3RB31 up to 80 A for standard applications

Selection and ordering data

3RB30 electronic overload relays, CLASS 10E

Features and technical specifications:

- Connection methods
 - Sizes S00 and S0:
Main and auxiliary circuit: Either screw or spring-type terminals
 - Size S2:
Main circuit: Screw terminals with box terminal or as straight-through transformer,
auxiliary circuit: Either screw or spring-type terminals
- Overload protection, phase failure protection and unbalance protection
- Internal power supply
- Auxiliary contacts 1 NO + 1 NC

- Manual and automatic RESET
- Switch position indicator
- TEST function and self-monitoring
- Sealable covers (optional accessory)

PU (UNIT, SET, M) = 1
 PS* = 1 unit
 PG = 41G



Size contactor ²⁾	Trip class	Current setting value of the inverse-time delayed overload release	Short-circuit protection with fuse, type of coordination "2", operational class gG ¹⁾	DT	Screw terminals	DT	Spring-type terminals	
CLASS	A	A			Article No.	Price per PU	Article No.	Price per PU

Size S00

S00 *Devices for mounting onto contactor²⁾*

10E	0.1 ... 0.4	4			▶ 3RB3016-1RB0	A	▶ 3RB3016-1RE0
10E	0.32 ... 1.25	6			▶ 3RB3016-1NB0	A	▶ 3RB3016-1NE0
10E	1 ... 4	20			▶ 3RB3016-1PB0	A	▶ 3RB3016-1PE0
10E	3 ... 12	25			▶ 3RB3016-1SB0	A	▶ 3RB3016-1SE0
10E	4 ... 16	25			▶ 3RB3016-1TB0	A	▶ 3RB3016-1TE0

Size S0

S0 *Devices for mounting onto contactor²⁾*

10E	0.1 ... 0.4	4			▶ 3RB3026-1RB0	A	▶ 3RB3026-1RE0
10E	0.32 ... 1.25	6			▶ 3RB3026-1NB0	A	▶ 3RB3026-1NE0
10E	1 ... 4	20			▶ 3RB3026-1PB0	A	▶ 3RB3026-1PE0
10E	3 ... 12	25			▶ 3RB3026-1SB0	A	▶ 3RB3026-1SE0
10E	6 ... 25	50			▶ 3RB3026-1QB0	A	▶ 3RB3026-1QE0
10E	10 ... 40	50			▶ 3RB3026-1VB0	A	▶ 3RB3026-1VE0

Size S2

S2 *Devices with screw terminals (main current side) and for mounting onto contactor²⁾*

10E	12 ... 50	250		NEW A	▶ 3RB3036-1UB0	A	▶ 3RB3036-1UD0
10E	20 ... 80	250		NEW A	▶ 3RB3036-1WB0	A	▶ 3RB3036-1WD0

Devices with straight-through transformer for stand-alone installation

10E	12 ... 50	250		NEW A	▶ 3RB3036-1UW1	A	▶ 3RB3036-1UX1
10E	20 ... 80	250		NEW A	▶ 3RB3036-1WW1	A	▶ 3RB3036-1WX1

¹⁾ Maximum protection by fuse only for overload relay, type of coordination "2". Fuse values in connection with contactors, see Configuration Manual "Configuring SIRIUS Innovations – Selection Data for Fuseless and Fused Load Feeders" <http://support.automation.siemens.com/WW/view/en/39714188>.

²⁾ With the appropriate terminal supports (see "Accessories", page 7/122), these overload relays can also be installed as stand-alone units.

Overload Relays

SIRIUS 3RB3 Electronic Overload Relays

3RB30, 3RB31 up to 80 A for standard applications

3RB30 electronic overload relays, CLASS 20E

Features and technical specifications:

- Connection methods
 - Sizes S00 and S0:
Main and auxiliary circuit: Either screw or spring-type terminals
 - Size S2:
Main circuit: Screw terminals with box terminal or as straight-through transformer,
auxiliary circuit: Either screw or spring-type terminals
- Overload protection, phase failure protection and unbalance protection
- Internal power supply
- Auxiliary contacts 1 NO + 1 NC
- Manual and automatic RESET
- Switch position indicator
- TEST function and self-monitoring
- Sealable covers (optional accessory)

PU (UNIT, SET, M) = 1
PS* = 1 unit
PG = 41G



Size contactor ²⁾	Trip class	Current setting value of the inverse-time delayed overload release	Short-circuit protection with fuse, type of coordination "2", operational class gG ¹⁾	DT	Screw terminals	DT	Spring-type terminals	
	CLASS	A	A		Article No.	Price per PU	Article No.	Price per PU

Size S00

S00 *Devices for mounting onto contactor²⁾*

20E	0.1 ... 0.4	4	▶	3RB3016-2RB0	A	3RB3016-2RE0
20E	0.32 ... 1.25	6	▶	3RB3016-2NB0	A	3RB3016-2NE0
20E	1 ... 4	20	▶	3RB3016-2PB0	A	3RB3016-2PE0
20E	3 ... 12	25	▶	3RB3016-2SB0	A	3RB3016-2SE0
20E	4 ... 16	25	▶	3RB3016-2TB0	A	3RB3016-2TE0

Size S0

S0 *Devices for mounting onto contactor²⁾*

20E	0.1 ... 0.4	4	▶	3RB3026-2RB0	A	3RB3026-2RE0
20E	0.32 ... 1.25	6	▶	3RB3026-2NB0	A	3RB3026-2NE0
20E	1 ... 4	20	▶	3RB3026-2PB0	A	3RB3026-2PE0
20E	3 ... 12	25	▶	3RB3026-2SB0	A	3RB3026-2SE0
20E	6 ... 25	50	▶	3RB3026-2QB0	A	3RB3026-2QE0
20E	10 ... 40	50	▶	3RB3026-2VB0	A	3RB3026-2VE0

Size S2

S2 *Devices with screw terminals (main current side) and for mounting onto contactor²⁾*

20E	12 ... 50	250	▶	NEW A 3RB3036-2UB0	A	3RB3036-2UD0
20E	20 ... 80	250	▶	NEW A 3RB3036-2WB0	A	3RB3036-2WD0

Devices with straight-through transformer for stand-alone installation

20E	12 ... 50	250	▶	NEW A 3RB3036-2UW1	A	3RB3036-2UX1
20E	20 ... 80	250	▶	NEW A 3RB3036-2WW1	A	3RB3036-2WX1

¹⁾ Maximum protection by fuse only for overload relay, type of coordination "2". Fuse values in connection with contactors, see Configuration Manual "Configuring SIRIUS Innovations – Selection Data for Fuseless and Fused Load Feeders"
<http://support.automation.siemens.com/WWW/view/en/39714188>.

²⁾ With the appropriate terminal supports (see "Accessories", page 7/122), these overload relays can also be installed as stand-alone units.

Overload Relays

SIRIUS 3RB3 Electronic Overload Relays

3RB30, 3RB31 up to 80 A for standard applications



3RB31 electronic overload relays, CLASS 5E, 10E, 20E or 30E (adjustable)

Features and technical specifications:

- Connection methods
 - Sizes S00 and S0: Main and auxiliary circuit: Either screw or spring-type terminals
 - Size S2: Main circuit: Screw terminals with box terminal or as straight-through transformer, auxiliary circuit: Either screw or spring-type terminals
- Overload protection, phase failure protection and unbalance protection
- Internal ground-fault detection (activatable)
- Internal power supply
- Auxiliary contacts 1 NO + 1 NC
- Manual and automatic RESET
- Electrical remote RESET integrated
- Switch position indicator
- TEST function and self-monitoring
- Sealable covers (optional accessory)

PU (UNIT, SET, M) = 1
 PS* = 1 unit
 PG = 41G



Size contactor ²⁾	Trip class	Current setting value of the inverse-time delayed overload release	Short-circuit protection with fuse, type of coordination "2", operational class gG ¹⁾	DT	Screw terminals 	DT	Spring-type terminals 	
	CLASS	A	A		Article No.	Price per PU	Article No.	Price per PU
Size S00								
S00	Devices for mounting onto contactor²⁾							
	5E, 10E, 20E or 30E adjustable	0.1 ... 0.4	4	▶	3RB3113-4RB0	A	3RB3113-4RE0	
		0.32 ... 1.25	6	▶	3RB3113-4NB0	A	3RB3113-4NE0	
		1 ... 4	20	▶	3RB3113-4PB0	A	3RB3113-4PE0	
		3 ... 12	25	▶	3RB3113-4SB0	A	3RB3113-4SE0	
		4 ... 16	25	▶	3RB3113-4TB0	A	3RB3113-4TE0	
Size S0								
S0	Devices for mounting onto contactor²⁾							
	5E, 10E, 20E or 30E adjustable	0.1 ... 0.4	4	▶	3RB3123-4RB0	A	3RB3123-4RE0	
		0.32 ... 1.25	6	▶	3RB3123-4NB0	A	3RB3123-4NE0	
		1 ... 4	20	▶	3RB3123-4PB0	A	3RB3123-4PE0	
		3 ... 12	25	▶	3RB3123-4SB0	A	3RB3123-4SE0	
		6 ... 25	50	▶	3RB3123-4QB0	A	3RB3123-4QE0	
		10 ... 40	50	▶	3RB3123-4VB0	A	3RB3123-4VE0	
Size S2								
S2	Devices with screw terminals (main current side) and for mounting onto contactor²⁾							
	5E, 10E, 20E or 30E adjustable	12 ... 50	250	NEW A	3RB3133-4UB0	A	3RB3133-4UD0	
		20 ... 80	250	NEW A	3RB3133-4WB0	A	3RB3133-4WD0	
	Devices with straight-through transformer for stand-alone installation							
	5E, 10E, 20E or 30E adjustable	12 ... 50	250	NEW A	3RB3133-4UW1	A	3RB3133-4UX1	
		20 ... 80	250	NEW A	3RB3133-4WW1	A	3RB3133-4WX1	

¹⁾ Maximum protection by fuse only for overload relay, type of coordination "2". Fuse values in connection with contactors, see Configuration Manual "Configuring SIRIUS Innovations – Selection Data for Fuseless and Fused Load Feeders" <http://support.automation.siemens.com/WWW/view/en/39714188>.

²⁾ With the appropriate terminal supports (see "Accessories", page 7/122), these overload relays can also be installed as stand-alone units.

Overload Relays

SIRIUS 3RB3 Electronic Overload Relays

Accessories









Overview

Overload relays for standard applications

The following optional accessories are available for the 3RB30/3RB31 electronic overload relays:

- Size-specific terminal support for stand-alone installation, in sizes S00 and S0 also with spring-type terminals
- Mechanical RESET (for all sizes)
- Cable release for resetting devices which are difficult to access (for all sizes)
- Sealable cover (for all sizes)

Selection and ordering data

Version	Size	DT	Article No.	Price per PU	PU (UNIT, SET, M)	PS*	PG	
Terminal supports for stand-alone installation								
 3RU2916-3AA01	Terminal supports for overload relays with screw terminals		Screw terminals 					
	For separate mounting of the overload relays; screw and snap-on mounting onto standard mounting rail	S00 ▶	3RU2916-3AA01		1	1 unit	41F	
		S0 ▶	3RU2926-3AA01		1	1 unit	41F	
		S2 NEW A	3RU2936-3AA01		1	1 unit	41F	
 3RU2926-3AA01	Terminal supports for overload relays with spring-type terminals		Spring-type terminals 					
	For separate mounting of the overload relays; screw and snap-on mounting onto standard mounting rail	S00 B	3RU2916-3AC01		1	1 unit	41F	
		S0 B	3RU2926-3AC01		1	1 unit	41F	
 3RU2936-3AA01								
 3RU2916-3AC01								
 3RU2926-3AC01								
Mechanical RESET								
 3RB3980-0A with pushbutton and extension plunger	Resetting plungers, holders and formers		S00 ... S2 ▶	3RB3980-0A		1	1 unit	41F
	Pushbuttons with extended stroke (12 mm), IP65, ø 22 mm		S00 ... S2 B	3SB3000-0EA11		1	1 unit	41J
	Extension plungers		S00 ... S2 A	3SX1335		1	1 unit	41J
	For compensation of the distance between a pushbutton and the unlatching button of the relay							

Overload Relays

SIRIUS 3RB3 Electronic Overload Relays

Accessories

Version	Size	DT	Article No.	Price per PU	PU (UNIT, SET, M)	PS*	PG
---------	------	----	-------------	--------------	-------------------	-----	----

Cable releases with holder for RESET



For \varnothing 6.5 mm holes in the control panel;
max. control panel thickness 8 mm

- Length 400 mm
- Length 600 mm

S00 ... S2 ▶
S00 ... S2 ▶

3RB3980-0B
3RB3980-0C

1 1 unit 41F
1 1 unit 41F

3RB3980-0.

Sealable covers



For covering the setting knobs

S00 ... S2 ▶

3RB3984-0

1 1 unit 41F

3RB3984-0

General accessories

Version	Size	Color	For overload relays	DT	Article No.	Price per PU	PU (UNIT, SET, M)	PS*	PG
---------	------	-------	---------------------	----	-------------	--------------	-------------------	-----	----

Tools for opening spring-type terminals



3RA2908-1A

Screwdrivers
For all SIRIUS devices
with spring-type
terminals

Length approx.
200 mm,
3.0 mm x 0.5 mm

Titanium
gray/
black,
partially
insulated

Main and
auxiliary
circuit
connection:
3RB3

A

Spring-type terminals

3RA2908-1A

1 1 unit 41B

Blank labels

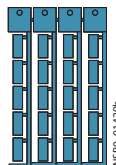

3RT1900-1SB20

Unit labeling plates¹⁾
for SIRIUS devices

20 mm x 7 mm

Pastel
turquoise

3RB3

D

3RT1900-1SB20

100 340 units 41B

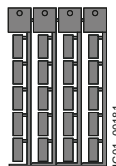

3RT2900-1SB20

20 mm x 7 mm

Titanium
gray

3RB3

D

3RT2900-1SB20

100 340 units 41B

¹⁾ PC labeling system for individual inscription
of unit labeling plates available from:
murrplastik Systemtechnik GmbH
(see Chapter 16, "Appendix" → "External Partners").

More information

Manuals

- System Manual "SIRIUS Innovations – System Overview"
<http://support.automation.siemens.com/WW/view/en/60311318>
- Manual "SIRIUS Innovations – SIRIUS 3RU2/3RB3 Overload Relays"
<http://support.automation.siemens.com/WW/view/en/60298164>

Overload Relays

SIRIUS 3RB2 Electronic Overload Relays

3RB20, 3RB21 up to 630 A for standard applications

Overview

Note:

The 3RB20 and 3RB21 devices (sizes S00/S0 to S12) can be found

- in the Catalog Add-On IC 10 AO · 2015 at the Information and Download Center
- in the interactive catalog CA 01
- in the Industry Mall

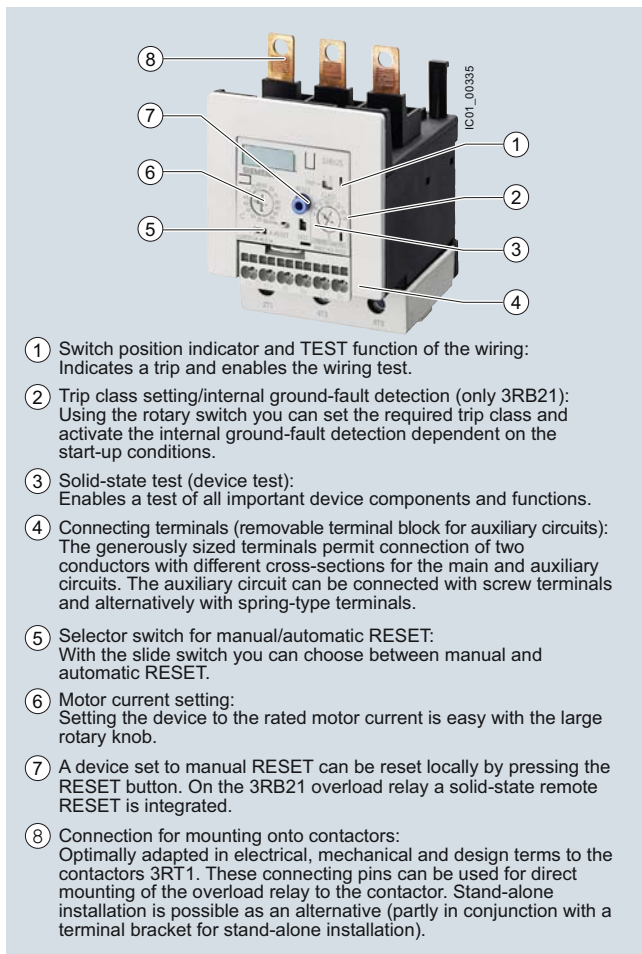

- ① Switch position indicator and TEST function of the wiring: Indicates a trip and enables the wiring test.
- ② Trip class setting/internal ground-fault detection (only 3RB21): Using the rotary switch you can set the required trip class and activate the internal ground-fault detection dependent on the start-up conditions.
- ③ Solid-state test (device test): Enables a test of all important device components and functions.
- ④ Connecting terminals (removable terminal block for auxiliary circuits): The generously sized terminals permit connection of two conductors with different cross-sections for the main and auxiliary circuits. The auxiliary circuit can be connected with screw terminals and alternatively with spring-type terminals.
- ⑤ Selector switch for manual/automatic RESET: With the slide switch you can choose between manual and automatic RESET.
- ⑥ Motor current setting: Setting the device to the rated motor current is easy with the large rotary knob.
- ⑦ A device set to manual RESET can be reset locally by pressing the RESET button. On the 3RB21 overload relay a solid-state remote RESET is integrated.
- ⑧ Connection for mounting onto contactors: Optimally adapted in electrical, mechanical and design terms to the contactors 3RT1. These connecting pins can be used for direct mounting of the overload relay to the contactor. Stand-alone installation is possible as an alternative (partly in conjunction with a terminal bracket for stand-alone installation).

SIRIUS 3RB2143-4ED0 electronic overload relay

The 3RB20 and 3RB21 electronic overload relays up to 630 A with internal power supply have been designed for inverse-time delayed protection of loads with normal and heavy starting ("Function", see Reference Manual "Protection Equipment – 3RU1, 3RB2 Overload Relays" <http://support.automation.siemens.com/WW/view/en/35681297>) against excessive temperature rises due to overload, phase unbalance or phase failure.

An overload, phase unbalance or phase failure result in an increase of the motor current beyond the set rated motor current. This current rise is detected by the current transformers integrated into the devices and evaluated by corresponding solid-state circuits which then output a pulse to the auxiliary contacts. The auxiliary contacts then switch off the load by means of a contactor. The break time depends on the ratio between the tripping current and current setting I_e and is stored in the form of a long-term stable tripping characteristic (see "Characteristic Curves" <http://support.automation.siemens.com/WW/view/en/20357046/134300>).

In addition to inverse-time delayed protection of loads against excessive temperature rises due to overload, phase unbalance and phase failure, the 3RB21 electronic overload relays also allow internal ground-fault detection (not possible in conjunction with contactor assemblies for wye-delta starting). This provides protection of loads against high-resistance short circuits due to damage to the insulation material, moisture, condensed water etc.

The "tripped" status is signaled by means of a switch position indicator. Resetting takes place either manually or automatically after the recovery time has elapsed ("Function", see Reference Manual "Protection Equipment – 3RU1, 3RB2 Overload Relays", <http://support.automation.siemens.com/WW/view/en/35681297>).

The 3RB2 electronic overload relays are suitable for operation with frequency converters. Please follow the instructions in the Reference Manual "Protection Equipment – 3RU1 and 3RB2 Overload Relays", see <http://support.automation.siemens.com/WW/view/en/35681297>.

The devices are manufactured in accordance with environmental guidelines and contain environmentally friendly and reusable materials. They comply with all important worldwide standards and approvals.

For 3RB30 and 3RB31 overload relay sizes S00 to S2, see page 7/119 onwards.

Use in hazardous areas

The 3RB20/3RB21 electronic overload relays are suitable for the overload protection of motors with the following types of protection:

- II (2) G [Ex e] [Ex d] [Ex px]
- II (2) D [Ex t] [Ex p]

EC type test certificate for Group II, Category (2) G/D exists. It has the number PTB 06 ATEX 3001.

Overload Relays

SIRIUS 3RB2 Electronic Overload Relays

3RB20, 3RB21 up to 630 A for standard applications

Article No. scheme

Digit of the Article No.	1st - 3rd	4th	5th	6th	7th	8th	9th	10th	11th	
	□□□	□	□	□	□	-	□	□	□	
Electronic overload relays	3 R B									
SIRIUS 2nd generation	2									
Device series	□									
Size, rated operational current and power	□									
Version of the automatic RESET, electrical remote RESET	□									
Trip class (CLASS)	□									
Setting range of the overload release	□									
Connection methods	□									
Installation type	□									
Example	3 R B	2	0	4	6	-	1	Q	B	0

Note:

The Article No. scheme is presented here merely for information purposes and for better understanding of the logic behind the article numbers.

For your orders, please use the article numbers quoted in the catalog in the Selection and ordering data.

Benefits

The most important features and benefits of the 3RB20/3RB21 electronic overload relays are listed in the overview table (see "General Data", page 7/87 onwards).

Application

Industries

The 3RB20 and 3RB21 electronic overload relays are suitable for customers from all industries who want to guarantee optimum inverse-time delayed protection of their electrical loads (e.g. motors) under normal and heavy starting conditions (CLASS 5 to 30), minimize project completion times, inventories and energy consumption, and optimize plant availability and maintenance management.

Application

The 3RB20 and 3RB21 electronic overload relays have been designed for the protection of three-phase motors in sinusoidal 50/60 Hz voltage networks. The relays are not suitable for the protection of single-phase AC or DC loads.

The 3RU11 thermal overload relays or the 3RB22 to 3RB24 solid-state overload relays can be used for single-phase AC loads. For DC loads we recommend the 3RU11 thermal overload relay.

Ambient conditions

The devices are insensitive to external influences such as shocks, corrosive ambient conditions, ageing and temperature fluctuations.

For the temperature range from -25 °C to +60 °C, the 3RB20 and 3RB21 electronic overload relays compensate the temperature in accordance with IEC 60947-4-1.

For the 3RB20 and 3RB21 electronic overload relays with the sizes S6, S10 and S12, the upper set value of the setting range must be reduced for ambient temperatures > 50 °C by a certain factor.

Overload Relays

SIRIUS 3RB2 Electronic Overload Relays

3RB20, 3RB21 up to 630 A for standard applications

Technical specifications

The following technical information is intended to provide an initial overview of the various types of device and functions.

Detailed information, see Reference Manual "Protection Equipment - Overload Relays 3RU1, 3RB2", <http://support.automation.siemens.com/WW/view/en/35681297>

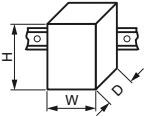

Type		3RB2046, 3RB2143	3RB2056, 3RB2153	3RB2066, 3RB2163
Size		S3	S6	S10/S12
Dimensions (W x H x D) (overload relay with stand-alone installation support)	 mm	70 x 86 x 124	120 x 119 x 155	145 x 147 x 156
General data				
Trips in the event of		Overload, phase failure, and phase unbalance + ground fault (for 3RB21 only)		
Trip class acc. to IEC 60947-4-1	CLASS	3RB20: 10 or 20; 3RB21: 5, 10, 20 and 30 adjustable		
Phase failure sensitivity		Yes		
Overload warning		No		
Reset and recovery		3RB20: Manual and automatic RESET; 3RB21: Manual, automatic and remote RESET		
• Reset options after tripping				
• Recovery time		Approx. 3 min		
- For automatic RESET		Immediately		
- For manual RESET		Immediately		
- For remote RESET		Immediately		
Features		Yes, by means of switch position indicator slide		
• Display of operating state on device		Yes, test of electronics by pressing the TEST button/ test of auxiliary contacts and wiring of control circuit by actuating the switch position indicator slide/self-monitoring		
• TEST function		Yes		
• RESET button		No		
• STOP button		No		
Protection and operation of explosion-proof motors		PTB 06 ATEX 3001 ⊗ II (2) G [Ex e] [Ex d] [Ex px] ⊗ II (2) G [Ex t] [Ex p] see http://support.automation.siemens.com/WW/view/en/23814648		
EC type test certificate number according to directive 94/9/EC (ATEX)				
Ambient temperatures				
• Storage/transport	°C	-40 ... +80		
• Operation	°C	-25 ... +60		
• Temperature compensation	°C	+60		
• Permissible rated current at				
- Temperature inside control cabinet 60 °C, stand-alone installation	%	100	100	100 or 90 ¹⁾
- Temperature inside control cabinet 60 °C, mounted on contactor	%	100	70	70
- Temperature inside control cabinet 70 °C	%	On request		
Degree of protection acc. to IEC 60529		IP20	IP20 (terminal compartment: IP00 degree of protection)	
Touch protection acc. to IEC 61140		Finger-safe for vertical contact from the front	Finger-safe; for busbar connection with cover	Finger-safe with cover
Shock resistance with sine acc. to IEC 60068-2-27	g/ms	15/11 (signaling contact 97/98 in position "tripped": 4 g/11 ms)		
Electromagnetic compatibility (EMC) – Interference immunity				
• Conductor-related interference				
- Burst acc. to IEC 61000-4-4 (corresponds to degree of severity 3)	kV	2 (power ports), 1 (signal ports)		
- Surge acc. to IEC 61000-4-5 (corresponds to degree of severity 3)	kV	2 (line to earth), 1 (line to line)		
• Electrostatic discharge according to IEC 61000-4-2 (corresponds to degree of severity 3)	kV	8 (air discharge), 6 (contact discharge)		
• Field-related interference acc. to IEC 61000-4-3 (corresponds to degree of severity 3)	V/m	10		
Electromagnetic compatibility (EMC) – emitted interference		Degree of severity B acc. to EN 55011 (CISPR 11) and EN 55022 (CISPR 22)		
Resistance to extreme climates – air humidity	%	100		
Dimensions		"Dimensional drawings", see Reference Manual "Protection Equipment - Overload Relays 3RU1, 3RB2", http://support.automation.siemens.com/WW/view/en/35681297		
Installation altitude above sea level	m	Up to 2 000		
Mounting position		Any		
Type of mounting		Direct mounting/stand-alone installation with terminal support	Direct mounting/stand-alone installation	

¹⁾ 90 % for relay with current setting range 160 A to 630 A.

Overload Relays

SIRIUS 3RB2 Electronic Overload Relays

3RB20, 3RB21 up to 630 A for standard applications

Type	3RB2046, 3RB2143	
Size	S3	
Main circuit		
Rated insulation voltage U_i (pollution degree 3)	V	1 000
Rated impulse withstand voltage U_{imp}	kV	8
Rated operational voltage U_e	V	1 000
Type of current		
• Direct current	No	
• Alternating current	Yes, 50/60 Hz \pm 5 %	
Current setting	A	12.5 ... 50, 25 ... 100
Power loss per unit (max.)	W	0.05
Short-circuit protection		
• With fuse without contactor	See "Selection and ordering data" on pages 7/130 to 7/132 "Short-Circuit Protection with Fuses/Motor Starter Protectors for Motor Feeders", see Reference Manual "Protection Equipment – 3RU1, 3RB2 Overload Relays", http://support.automation.siemens.com/WW/view/en/35681297 → "Technical Specifications" → "Short-Circuit Protection with Fuses for Motor Feeders"	
• With fuse and contactor		
Protective separation between main and auxiliary current paths acc. to IEC 60947-1 (pollution degree 2)		
• For systems with grounded neutral point	V	690
• For systems with ungrounded neutral point	V	600
Conductor cross-sections of the main circuit		
Connection type	 Screw terminals with box terminal	
Terminal screw	M8, 4 mm Allen screw	
Operating devices	mm	4 mm Allen screw
Prescribed tightening torque	Nm	4 ... 6
Conductor cross-sections (min./max.) , 1 or 2 conductors can be connected		
• Solid	mm ²	2 × (2.5 ... 16)
• Finely stranded without end sleeve	mm ²	--
• Finely stranded with end sleeve (DIN 46228-1)	mm ²	2 × (2.5 ... 35) ¹⁾ , 1 × (2.5 ... 50) ¹⁾
• Stranded	mm ²	2 × (10 ... 50) ¹⁾ , 1 × (10 ... 70) ¹⁾
• AWG cables, solid or stranded	AWG	2 × (10 ... 1/0) ¹⁾ , 1 × (10 ... 2/0) ¹⁾
• Ribbon cables (Number x Width x Thickness)	mm	2 × (6 × 9 × 0.8)
Connection type	 Busbar connections	
Terminal screw	M6 × 20	
Prescribed tightening torque	Nm	4 ... 6
Conductor cross-sections (min./max.)		
• Finely stranded with cable lug	mm ²	2 × 70
• Stranded with cable lug	mm ²	3 × 70
• AWG cables, solid or stranded, with cable lug	AWG	2/0
• With connecting bars (max. width)	mm	12
Connection type	 Straight-through transformers	
Diameter of opening	mm	18



¹⁾ If two different conductor cross-sections are connected to one clamping point, both cross-sections must be in the range specified.



Overload Relays

SIRIUS 3RB2 Electronic Overload Relays

3RB20, 3RB21 up to 630 A for standard applications

Type		3RB2056, 3RB2153	3RB2066, 3RB2163
Size		S6	S10/S12
Main circuit			
Rated insulation voltage U_i (pollution degree 3)	V	1 000	
Rated impulse withstand voltage U_{imp}	kV	8	
Rated operational voltage U_e	V	1 000	
Type of current			
• Direct current		No	
• Alternating current		Yes, 50/60 Hz \pm 5 %	
Current setting	A	50 ... 200	55 ... 250, 160 ... 630
Power loss per unit (max.)	W	0.05	
Short-circuit protection			
• With fuse without contactor		See "Selection and ordering data" on pages 7/130 to 7/132	
• With fuse and contactor		"Short-Circuit Protection with Fuses/Motor Starter Protectors for Motor Feeders"	
See Reference Manual "Protection Equipment – 3RU1, 3RB2 Overload Relays", http://support.automation.siemens.com/WW/view/en/35681297 → "Technical Specifications" → "Short-Circuit Protection with Fuses for Motor Feeders"			
Protective separation between main and auxiliary current paths acc. to IEC 60947-1 (pollution degree 2)			
• For systems with grounded neutral point	V	690	
• For systems with ungrounded neutral point	V	600	
Conductor cross-sections of the main circuit			
Connection type		 Screw terminals with box terminal	
Terminal screw	mm	4 mm Allen screw	5 mm Allen screw
Operating devices	mm	4 mm Allen screw	5 mm Allen screw
Prescribed tightening torque	Nm	1 ... 12	20 ... 22
Conductor cross-sections (min./max.), 1 or 2 conductors can be connected			
• Solid	mm ²	--	--
• Finely stranded without end sleeve	mm ²	With 3RT1955-4G box terminal: 2 × (1 × max. 50, 1 × max. 70), 1 × (10 ... 70); With 3RT1956-4G box terminal: 2 × (1 × max. 95, 1 × max. 120), 1 × (10 ... 120)	2 × (50 ... 185), Rear clamping point only: 1 × (70 ... 240); rear clamping point only: 1 × (120 ... 185)
• Finely stranded with end sleeve (DIN 46228-1)	mm ²	With 3RT1955-4G box terminal: 2 × (1 × max. 50, 1 × max. 70), 1 × (10 ... 70); With 3RT1956-4G box terminal: 2 × (1 × max. 95, 1 × max. 120), 1 × (10 ... 120)	2 × (50 ... 185), Rear clamping point only: 1 × (70 ... 240); rear clamping point only: 1 × (120 ... 185)
• Stranded	mm ²	With 3RT1955-4G box terminal: 2 × (max. 70), 1 × (16 ... 70); With 3RT1956-4G box terminal: 2 × (max. 120), 1 × (16 ... 120)	2 × (70 ... 240), Rear clamping point only: 1 × (95 ... 300); rear clamping point only: 1 × (120 ... 240)
• AWG cables, solid or stranded	AWG	With 3RT1955-4G box terminal: 2 × (max. 1/0), 1 × (6 ... 2/0); With 3RT1956-4G box terminal: 2 × (max. 3/0), 1 × (6 ... 250 kcmil)	2 × (2/0 ... 500 kcmil), rear clamping point only: 1 × (3/0 ... 600 kcmil); rear clamping point only: 1 × (250 kcmil ... 500 kcmil)
• Ribbon cables (Number x Width x Thickness)	mm	With 3RT1955-4G box terminal: 2 × (6 × 15.5 × 0.8), 1 × (3 × 9 × 0.8 ... 6 × 15.5 × 0.8); With 3RT1956-4G box terminal: 2 × (10 × 15.5 × 0.8), 1 × (3 × 9 × 0.8 ... 10 × 15.5 × 0.8)	2 × (20 × 24 × 0.5), 1 × (6 × 9 × 0.8 ... 20 × 24 × 0.5)
Connection type		 Busbar connections	
Terminal screw		M8 × 25	M10 × 30
Prescribed tightening torque	Nm	10 ... 14	14 ... 24
Conductor cross-sections (min./max.)			
• Finely stranded with cable lug	mm ²	16 ... 95 ¹⁾	50 ... 240 ²⁾
• Stranded with cable lug	mm ²	25 ... 120 ¹⁾	70 ... 240 ²⁾
• AWG cables, solid or stranded, with cable lug	AWG	4 ... 250 kcmil	2/0 ... 500 kcmil
• With connecting bars (max. width)	mm	15	25
Connection type		 Straight-through transformers	
Diameter of opening	mm	24.5	--



¹⁾ When connecting cable lugs according to DIN 46235 with conductor cross-sections of 95 mm² and more, the 3RT1956-4EA1 terminal cover must be used to ensure phase clearance.

²⁾ When connecting cable lugs according to DIN 46234 with conductor cross-sections of 240 mm² and more as well as to DIN 46235 with conductor cross-sections of 185 mm² and more, the 3RT1956-4EA1 terminal cover must be used to ensure the phase clearance.

Overload Relays

SIRIUS 3RB2 Electronic Overload Relays

3RB20, 3RB21 up to 630 A for standard applications

Type	3RB2046, 3RB2143	3RB2056, 3RB2153	3RB2066, 3RB2163
Size	S3	S6	S10/S12
Auxiliary circuit			
Number of NO contacts	1		
Number of NC contacts	1		
Auxiliary contacts – assignment	1 NO for the signal "tripped"; 1 NC for disconnecting the contactor		
Rated insulation voltage U_i (pollution degree 3)	V	300	
Rated impulse withstand voltage U_{imp}	kV	4	
Auxiliary contacts – contact rating			
<ul style="list-style-type: none"> NC contact with alternating current AC-14/AC-15, rated operational current I_e at U_e: <ul style="list-style-type: none"> - 24 V A 4 - 120 V A 4 - 125 V A 4 - 250 V A 3 NO contact with alternating current AC-14/AC-15, rated operational current I_e at U_e: <ul style="list-style-type: none"> - 24 V A 4 - 120 V A 4 - 125 V A 4 - 250 V A 3 NC contact, NO contact with direct current DC-13, rated operational current I_e at U_e: <ul style="list-style-type: none"> - 24 V A 2 - 60 V A 0.55 - 110 V A 0.3 - 125 V A 0.3 - 250 V A 0.11 Conventional thermal current I_{th} A 5 Contact reliability (suitability for PLC control; 17 V, 5 mA) Yes 			
Short-circuit protection			
<ul style="list-style-type: none"> With fuse, operational class gG A 6 			
Ground-fault protection (only 3RB21)			
<ul style="list-style-type: none"> Tripping value I_{Δ} Operating range I Response time t_{trip} (in steady-state condition) s 		The information refers to sinusoidal residual currents at 50/60 Hz. $> 0.75 \times I_{motor}$ Lower current setting value $< I_{motor} < 3.5 \times$ upper current setting value < 1	
Integrated electrical remote RESET (only 3RB21)			
Connecting terminals A3, A4		24 V DC, 100 mA, 2.4 W short-term	
Protective separation between auxiliary current paths acc. to IEC 60947-1 V		300	
CSA, UL, UR rated data			
Auxiliary circuit – switching capacity		B300, R300	
Conductor cross-sections of the auxiliary circuit			
Connection type		 Screw terminals	
Terminal screw		M3, Pozidriv size 2	
Operating devices	mm	Ø 5 ... 6	
Prescribed tightening torque	Nm	0.8 ... 1.2	
Conductor cross-sections (min./max.), 1 or 2 conductors can be connected <ul style="list-style-type: none"> Solid and stranded mm² 1 × (0.5 ... 4)¹⁾, 2 × (0.5 ... 2.5)¹⁾ Finely stranded without end sleeve mm² -- Finely stranded with end sleeve (DIN 46228-1) mm² 1 × (0.5 ... 2.5)¹⁾, 2 × (0.5 ... 1.5)¹⁾ AWG cables, solid or stranded AWG 2 × (20 ... 14) 			
Connection type		 Spring-type terminals	
Operating devices	mm	3.0 x 0.5	
Conductor cross-sections (min./max.), 1 or 2 conductors can be connected <ul style="list-style-type: none"> Solid and stranded mm² 2 × (0.25 ... 1.5) Finely stranded without end sleeve mm² -- Finely stranded with end sleeve (DIN 46228-1) mm² 2 × (0.25 ... 1.5) AWG cables, solid or stranded AWG 2 × (24 ... 16) 			

¹⁾ If two different conductor cross-sections are connected to one clamping point, both cross-sections must be in the range specified.

Overload Relays

SIRIUS 3RB2 Electronic Overload Relays

3RB20, 3RB21 up to 630 A for standard applications

Selection and ordering data

3RB20 electronic overload relays for mounting onto contactors and stand-alone installation, CLASS 10

Features and technical specifications:

- Connection methods
 - Size S3
Main circuit: Busbar connection with box terminal or as straight-through transformer,
auxiliary circuit: Either screw or spring-type terminals
 - Size S6
Main circuit: With busbar connection or as straight-through transformer,
auxiliary circuit: Either screw or spring-type terminals
 - Sizes S10/S12:
Main circuit: With busbar connection,
auxiliary circuit: Either screw or spring-type terminals
- Overload protection, phase failure protection and unbalance protection
- Internal power supply
- Auxiliary contacts 1 NO + 1 NC
- Manual and automatic RESET
- Switch position indicator
- TEST function and self-monitoring

PU (UNIT, SET, M) = 1
PS* = 1 unit
PG = 41G



3RB2046-1ED0



3RB2056-1FW2



3RB2066-1MF2

Size contactor	Trip class	Current setting value of the inverse-time delayed overload release	Short-circuit protection with fuse, type of coordination "2", operational class gG ¹⁾	DT	Screw terminals (on auxiliary current side)	DT	Spring-type terminals (on auxiliary current side)	
	CLASS	A	A		Article No.	Price per PU	Article No.	Price per PU

Size S3

Devices with screw terminals, for mounting onto contactor

S3	10	12.5 ... 50	160	▶	3RB2046-1UB0	A	3RB2046-1UD0
S3	10	25 ... 100	315	▶	3RB2046-1EB0	A	3RB2046-1ED0

Devices with straight-through transformer, for stand-alone installation

S3	10	25 ... 100	315	▶	3RB2046-1EW1	▶	3RB2046-1EX1
----	----	------------	-----	---	--------------	---	--------------

Size S6

Devices with connecting bar, for mounting onto contactor and stand-alone installation

S6	10	50 ... 200	315	▶	3RB2056-1FC2	A	3RB2056-1FF2
----	----	------------	-----	---	--------------	---	--------------

Devices with straight-through transformer, for mounting onto contactor and stand-alone installation

For mounting onto S6 contactors with box terminals	10	50 ... 200	315	▶	3RB2056-1FW2	▶	3RB2056-1FX2
--	----	------------	-----	---	--------------	---	--------------

Size S10/S12

Devices with connecting bar, for mounting onto contactor and stand-alone installation

S10/S12	10	55 ... 250	400	▶	3RB2066-1GC2	▶	3RB2066-1GF2
and size 14 (3TF68/3TF69) ²⁾	10	160 ... 630	800	▶	3RB2066-1MC2	▶	3RB2066-1MF2

¹⁾ Maximum protection by fuse only for overload relay, type of coordination "2". For fuse values in connection with contactors, see the Reference Manual "Protection Equipment – 3RU1, 3RB2 Overload Relays", <http://support.automation.siemens.com/WW/view/en/35681297> → "Technical Specifications" → "Short-Circuit Protection with Fuses for Motor Feeders".

²⁾ For 3TF68/3TF69 contactors, direct mounting is not possible.

Overload Relays

SIRIUS 3RB2 Electronic Overload Relays

3RB20, 3RB21 up to 630 A for standard applications
3RB20 electronic overload relays for mounting onto contactors and stand-alone installation, CLASS 20

Features and technical specifications:

- Connection methods
 - Size S3
Main circuit: Busbar connection with box terminal or as straight-through transformer, auxiliary circuit: Either screw or spring-type terminals
 - Size S6
Main circuit: With busbar connection or as straight-through transformer, auxiliary circuit: Either screw or spring-type terminals
 - Sizes S10/S12:
Main circuit: With busbar connection, auxiliary circuit: Either screw or spring-type terminals
- Overload protection, phase failure protection and unbalance protection
- Internal power supply
- Auxiliary contacts 1 NO + 1 NC
- Manual and automatic RESET
- Switch position indicator
- TEST function and self-monitoring

 PU (UNIT, SET, M) = 1
 PS* = 1 unit
 PG = 41G



3RB2046-2ED0



3RB2056-2FW2



3RB2066-2MF2

Size contactor	Trip class	Current setting value of the inverse-time delayed overload release	Short-circuit protection with fuse, type of coordination "2", operational class gG ¹⁾	DT	Screw terminals (on auxiliary current side) 	DT	Spring-type terminals (on auxiliary current side) 	
CLASS		A	A		Article No.	Price per PU	Article No.	Price per PU

Size S3
Devices with screw terminals, for mounting onto contactor

S3	20	12.5 ... 50	160	▶	3RB2046-2UB0	A	3RB2046-2UD0
S3	20	25 ... 100	315	▶	3RB2046-2EB0	A	3RB2046-2ED0

Devices with straight-through transformer, for stand-alone installation

S3	20	25 ... 100	315	▶	3RB2046-2EW1	▶	3RB2046-2EX1
----	----	------------	-----	---	---------------------	---	---------------------

Size S6
Devices with connecting bar, for mounting onto contactor and stand-alone installation

S6	20	50 ... 200	315	▶	3RB2056-2FC2	A	3RB2056-2FF2
----	----	------------	-----	---	---------------------	---	---------------------

Devices with straight-through transformer, for mounting onto contactor and stand-alone installation

For mounting onto S6 contactors with box terminals	20	50 ... 200	315	▶	3RB2056-2FW2	▶	3RB2056-2FX2
--	----	------------	-----	---	---------------------	---	---------------------

Size S10/S12²⁾
Devices with connecting bar, for mounting onto contactor and stand-alone installation

S10/S12	20	55 ... 250	400	▶	3RB2066-2GC2	▶	3RB2066-2GF2
and size 14 (3TF68/3TF69) ²⁾	20	160 ... 630	800	▶	3RB2066-2MC2	▶	3RB2066-2MF2

¹⁾ Maximum protection by fuse only for overload relay, type of coordination "2". For fuse values in connection with contactors, see the Reference Manual "Protection Equipment – 3RU1, 3RB2 Overload Relays", <http://support.automation.siemens.com/WW/view/en/35681297> → "Technical Specifications" → "Short-Circuit Protection with Fuses for Motor Feeders".

²⁾ For 3TF68/3TF69 contactors, direct mounting is not possible.

Overload Relays

SIRIUS 3RB2 Electronic Overload Relays

3RB20, 3RB21 up to 630 A for standard applications

3RB21 electronic overload relays for mounting onto contactors and stand-alone installation, CLASS 5, 10, 20 and 30 adjustable

Features and technical specifications:

- Connection methods
 - Size S3
Main circuit: Busbar connection with box terminal or as straight-through transformer, auxiliary circuit: Either screw or spring-type terminals
 - Size S6
Main circuit: With busbar connection or as straight-through transformer, auxiliary circuit: Either screw or spring-type terminals
 - Sizes S10/S12:
Main circuit: With busbar connection, auxiliary circuit: Either screw or spring-type terminals
- Overload protection, phase failure protection and unbalance protection
- Internal ground-fault detection (activatable)
- Internal power supply
- Auxiliary contacts 1 NO + 1 NC
- Manual and automatic RESET
- Electrical remote RESET integrated
- Switch position indicator
- TEST function and self-monitoring

PU (UNIT, SET, M) = 1
PS* = 1 unit
PG = 41G



3RB2143-4ED0



3RB2153-4FX2



3RB2163-4MC2

Size contactor	Trip class	Current setting value of the inverse-time delayed overload release	Short-circuit protection with fuse, type of coordination "2", operational class gG ¹⁾	DT	Screw terminals (on auxiliary current side)	DT	Spring-type terminals (on auxiliary current side)	
	CLASS	A	A		Article No.	Price per PU	Article No.	Price per PU

Size S3

Devices with screw terminals, for mounting onto contactor

S3	5, 10, 20 and 30	12.5 ... 50	160	▶	3RB2143-4UB0	▶	3RB2143-4UD0
S3	adjustable	25 ... 100	315	▶	3RB2143-4EB0	▶	3RB2143-4ED0

Devices with straight-through transformer, for stand-alone installation

S3				▶	3RB2143-4EW1	▶	3RB2143-4EX1
----	--	--	--	---	--------------	---	--------------

Size S6

Devices with connecting bar, for mounting onto contactor and stand-alone installation

S6	5, 10, 20 and 30 adjustable	50 ... 200	315	▶	3RB2153-4FC2	▶	3RB2153-4FF2
----	-----------------------------	------------	-----	---	--------------	---	--------------

Devices with straight-through transformer, for mounting onto contactor and stand-alone installation

For mounting onto S6 contactors with box terminals	5, 10, 20 and 30 adjustable			▶	3RB2153-4FW2	▶	3RB2153-4FX2
--	-----------------------------	--	--	---	--------------	---	--------------

Size S10/S12²⁾

Devices with connecting bar, for mounting onto contactor and stand-alone installation

S10/S12 and size 14 (3TF68/ ²⁾ 3TF69 ²⁾)	5, 10, 20 and 30 adjustable	55 ... 250 160 ... 630	400 800	▶	3RB2163-4GC2	▶	3RB2163-4GF2
				▶	3RB2163-4MC2	▶	3RB2163-4MF2

¹⁾ Maximum protection by fuse only for overload relay, type of coordination "2". For fuse values in connection with contactors, see the Reference Manual "Protection Equipment – 3RU1, 3RB2 Overload Relays", <http://support.automation.siemens.com/WW/view/en/35681297> → "Technical Specifications" → "Short-Circuit Protection with Fuses for Motor Feeders".

²⁾ For 3TF68/3TF69 contactors, direct mounting is not possible.







Overview

Overload relays for standard applications

The following optional accessories are available for the 3RB20 and 3RB21 electronic overload relays:

- Mechanical RESET (for all sizes)
- Cable release for resetting devices which are difficult to access (for all sizes)
- Sealable cover (for all sizes)
- Terminal covers for sizes S3 to S10/S12
- Box terminal blocks for sizes S6 and S10/S12

Selection and ordering data

Version	Size	DT	Article No.	Price per PU	PU (UNIT, SET, M)	PS*	PG
Mechanical RESET							
 <p>3RU1900-1A with pushbutton and extension plunger</p>	Resetting plungers, holders and formers		S3 ... S10/S12 ▶	3RU1900-1A	1	1 unit	41F
	Pushbuttons with extended stroke (12 mm), IP65, Ø 22 mm		S3 ... S10/S12 B	3SB3000-0EA11	1	1 unit	41J
	Extension plungers For compensation of the distance between a pushbutton and the unlatching button of the relay		S3 ... S10/S12 A	3SX1335	1	1 unit	41J
Cable releases with holder for RESET							
 <p>3RU1900-1.</p>	For Ø 6.5 mm holes in the control panel; max. control panel thickness 8 mm		S3 ... S10/S12				
	<ul style="list-style-type: none"> • Length 400 mm ▶ • Length 600 mm ▶ 			3RU1900-1B 3RU1900-1C	1 1	1 unit 1 unit	41F 41F
Sealable covers							
 <p>3RB2984-0</p>	For covering the setting knobs		S3 ... S10/S12 ▶	3RB2984-0	1	10 units	41F
Terminal covers							
 <p>3RT1956-4EA1</p>	Covers for cable lugs and busbar connections						
	<ul style="list-style-type: none"> • Length 55 mm S3 B ▶ • Length 100 mm S6 ▶ • Length 120 mm S10/S12 ▶ 			3RT1946-4EA1 3RT1956-4EA1 3RT1966-4EA1	1 1 1	1 unit 1 unit 1 unit	41B 41B 41B
	Covers for box terminals						
 <p>3RT1956-4EA2</p>	<ul style="list-style-type: none"> • Length 20.8 mm S3 ▶ • Length 25 mm S6 ▶ • Length 30 mm S10/S12 ▶ 			3RT1946-4EA2 3RT1956-4EA2 3RT1966-4EA2	1 1 1	1 unit 1 unit 1 unit	41B 41B 41B
	Covers for screw terminals between contactor and overload relay, without box terminals (1 unit required per combination)		S6 ▶ S10/S12 ▶	3RT1956-4EA3 3RT1966-4EA3	1 1	1 unit 1 unit	41B 41B
	Box terminal blocks						
 <p>3RT195.-4G</p>	For round and ribbon cables						
	<ul style="list-style-type: none"> • Up to 70 mm² S6¹⁾ ▶ • Up to 120 mm² S6 ▶ • Up to 240 mm² S10/S12 ▶ 			3RT1955-4G 3RT1956-4G 3RT1966-4G	1 1 1	1 unit 1 unit 1 unit	41B 41B 41B
	For technical specifications for conductor cross-sections, see Reference Manual "Protection Equipment – 3RU1, 3RB2 Overload Relays", http://support.automation.siemens.com/WWW/view/en/35681297 .						

¹⁾ In the scope of supply for 3RT1054-1 contactors (55 kW).

Overload Relays



SIRIUS 3RB2 Electronic Overload Relays

Accessories for 3RB20, 3RB21

General accessories

Version	Size	Color	For over-load relays	DT	Article No.	Price per PU	PU (UNIT, SET, M)	PS*	PG
---------	------	-------	----------------------	----	-------------	--------------	-------------------	-----	----

Tools for opening spring-type terminals

 3RA2908-1A	Screwdrivers For all SIRIUS devices with spring-type terminals	Length approx. 200 mm, 3.0 mm x 0.5 mm	Titanium gray/black, partially insulated	Main and auxiliary circuit connection: 3RB2	A	Spring-type terminals 	1	1 unit	41B
						3RA2908-1A			

Blank labels

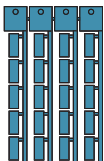
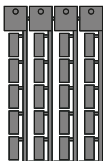
 3RT1900-1SB20	Unit labeling plates¹⁾ for SIRIUS devices	20 mm x 7 mm	Pastel turquoise	3RB2	D	3RT1900-1SB20	100	340 units	41B
		20 mm x 7 mm	Titanium gray	3RB2	D	3RT2900-1SB20	100	340 units	41B
 3RT2900-1SB20	Adhesive inscription labels¹⁾ For SIRIUS devices	19 mm x 6 mm	Pastel turquoise	3RB2	C	3RT1900-1SB60	100	3 060 units	41B
		19 mm x 6 mm	Zinc yellow	3RB2	C	3RT1900-1SD60	100	3 060 units	41B

¹⁾ PC labeling system for individual inscription of unit labeling plates available from: murrplastik Systemtechnik GmbH (see Chapter 16, "Appendix" → "External Partners").

Overload Relays

SIRIUS 3RB2 Electronic Overload Relays

3RB22, 3RB23 up to 630 A for High-Feature applications

Overview

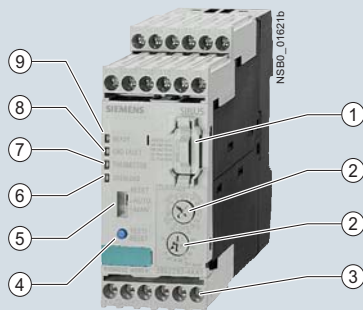

- ① 3RB2985 function expansion module:
Enables more functions to be added, e.g. internal ground-fault detection and/or an analog output with corresponding signals.
- ② Motor current and trip class setting:
Setting the device to the motor current and to the required trip class dependent on the start-up conditions is easy with the two rotary switches.
- ③ Connecting terminals (removable joint block):
The generously sized terminals permit connection of two conductors with different cross-sections for the auxiliary, control and sensor circuits. Connection is possible with screw connection and alternatively with spring-type connection.
- ④ Test/RESET button:
Enables testing of all important device components and functions, plus resetting of the device after a trip when manual RESET is selected.
- ⑤ Selector switch for manual/automatic RESET:
With this switch you can choose between manual and automatic RESET.
- ⑥ Red LED "OVERLOAD":
A continuous red light signals an active overload trip; a flickering red light signals an imminent trip (overload warning).
- ⑦ Red LED "THERMISTOR":
A continuous red light signals an active thermistor trip.
- ⑧ Red LED "GND FAULT":
A continuous red light signals a ground-fault tripping.
- ⑨ Green LED "READY":
A continuous green light signals that the device is working correctly.

SIRIUS 3RB22 and 3RB23 evaluation modules

The 3RB22 and 3RB23 electronic overload relays up to 630 A (up to 820 A possible in combination with a series transformer) are from a modular system and comprise an evaluation unit, a current measuring module and a connecting cable. The 3RB22 overload relays (with monostable auxiliary contacts) and the 3RB23 overload relays (with bistable auxiliary contacts) are supplied from an external voltage.

These units have been designed for inverse-time delayed protection of loads with normal and heavy starting ("Function", see Reference Manual "Protection Equipment – 3RU1, 3RB2 Overload Relays", <http://support.automation.siemens.com/WW/view/en/35681297>) against excessive temperature rises due to overload, phase unbalance or phase failure. An overload, phase unbalance or phase failure result in an increase of the motor current beyond the set rated motor current.

This current rise is detected by means of a current measuring module (see page 7/152) and electronically evaluated by the evaluation module which is connected to it. The evaluation electronics sends a signal to the auxiliary contacts. The auxiliary contacts then switch off the load by means of a contactor.

The break time depends on the ratio between the tripping current and current setting I_e and is stored in the form of a long-term stable tripping characteristic (see "Characteristic Curves" <http://support.automation.siemens.com/WW/view/en/20357046/134300>).

The "tripped" status is signaled by means of a continuous red "OVERLOAD" LED.

The LED indicates imminent tripping of the relay due to overload, phase unbalance or phase failure by flickering when the limit current has been violated. In the case of the 3RB22 and 3RB23 overload relays this warning can also be issued through auxiliary contacts.

In addition to the described inverse-time delayed protection of loads against excessive temperature rises, the 3RB22 and 3RB23 electronic overload relays also allow direct temperature monitoring of the motor windings (full motor protection) by connection with broken-wire interlock of a PTC sensor circuit. With this temperature-dependent protection, the loads can be protected against overheating caused indirectly by reduced coolant flow, for example, which cannot be detected by means of the current alone. In the event of overheating, the devices switch off the contactor, and thus the load, by means of the auxiliary contacts. The "tripped" status is signaled by means of a continuously illuminated "THERMISTOR" LED.

To protect the loads against high-resistance short circuits due to damage to the insulation, humidity, condensed water, etc., the 3RB22 and 3RB23 electronic overload relays offer the possibility of internal ground-fault detection in conjunction with a function expansion module (for details, see Reference Manual "Protection Equipment – Overload Relays 3RU1, 3RB2", <http://support.automation.siemens.com/WW/view/en/35681297>, not possible in conjunction with contactor assemblies for wye-delta starting). In the event of a ground fault the 3RB22 and 3RB23 relays trip instantaneously.

The "tripped" status is signaled by means of a continuous red "Ground Fault" LED. Signaling through auxiliary contacts is also possible.

After tripping due to overload, phase unbalance, phase failure, thermistor or ground-fault tripping, the relay is reset manually or automatically after the recovery time has elapsed ("Function", see Reference Manual "Protection Equipment – 3RU1, 3RB2 Overload Relays" <http://support.automation.siemens.com/WW/view/en/35681297>). In conjunction with a function expansion module, the motor current measured by the microprocessor can be output in the form of an analog signal DC 4 mA to 20 mA for operating rotary coil instruments or for feeding into analog inputs of programmable logic controllers.

With an additional AS-Interface analog module the current values can also be transferred over the AS-i bus system.

The 3RB2 electronic overload relays are suitable for operation with frequency converters. Please follow the instructions in the Reference Manual "Protection Equipment – 3RU1 and 3RB2 Overload Relays", see <http://support.automation.siemens.com/WW/view/en/35681297>.

The devices are manufactured in accordance with environmental guidelines and contain environmentally friendly and reusable materials. They comply with all important worldwide standards and approvals.

Use in hazardous areas

The 3RB22 electronic overload relays (monostable) with the 3RB29 current measuring module are suitable for the overload protection of explosion-proof motors.

EC type test certificate for Category (2) G/D exists. It has the number PTB 05 ATEX 3022.

Overload Relays

SIRIUS 3RB2 Electronic Overload Relays

3RB22, 3RB23 up to 630 A for High-Feature applications

Article No. scheme

Digit of the Article No.	1st - 3rd	4th	5th	6th	7th	8th	9th	10th	11th
	□□□	□	□	□	□	-	□	□	□
Electronic overload relays	3 R B								
SIRIUS 2nd generation	2								
Device series			□						
Size, rated operational current and power				□					
Version of the automatic RESET, electrical remote RESET					□				
Trip class (CLASS)							□		
Setting range of the overload release								□	
Connection methods									□
Installation type									□
Example	3 R B	2	2	8	3	-	4	A	A 1

Note:

The Article No. scheme is presented here merely for information purposes and for better understanding of the logic behind the article numbers.

For your orders, please use the article numbers quoted in the catalog in the Selection and ordering data.

Benefits

The most important features and benefits of the 3RB22 and 3RB23 electronic overload relays are listed in the overview table (see "General Data", page 7/87 onwards).

Advantages through energy efficiency

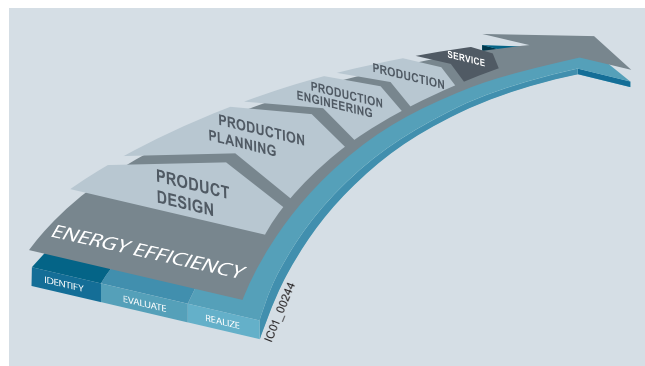

Overview of the energy management process

We offer you a unique portfolio for industrial energy management, using an energy management system that helps to optimally define your energy needs. We split up our industrial energy management into three phases – identify, evaluate, and realize – and we support you with the appropriate hardware and software solutions in every process phase.

The innovative products of the SIRIUS industrial controls portfolio can also make a substantial contribution to a plant's energy efficiency (see www.siemens.com/sirius/energysaving).

3RB22 and 3RB23 electronic overload relays contribute to energy efficiency throughout the plant as follows:

- Reduced inherent power loss
- Less heating of the control cabinet
- Smaller control cabinet air conditioners can be used

Application

Industries

The 3RB22 and 3RB23 electronic overload relays are suitable for customers from all industries who want to guarantee optimum inverse-time delayed and temperature-dependent protection of their electrical loads (e.g. motors) under normal and heavy starting conditions (CLASS 5 to 30), minimize project completion times, inventories and energy consumption, and optimize plant availability and maintenance management.

Application

The 3RB22 and 3RB23 devices have been designed for the protection of three-phase asynchronous and single-phase AC motors.

If single-phase AC motors are to be protected by the 3RB22 and 3RB23 electronic overload relays, the main current paths of the current measuring modules must be series-connected ("Circuit Diagrams", see [Reference Manual "Protection Equipment – 3RU1, 3RB2 Overload Relays"](#) <http://support.automation.siemens.com/WW/view/en/35681297>).

Ambient conditions

The devices are insensitive to external influences such as shocks, corrosive ambient conditions, ageing and temperature fluctuations.

For the temperature range from –25 °C to +60 °C, the 3RB22 and 3RB23 electronic overload relays compensate the temperature in accordance with IEC 60947-4-1.

Configuration notes for use of the devices below –25 °C or above +60 °C on request.

Overload Relays

SIRIUS 3RB2 Electronic Overload Relays



3RB22, 3RB23 up to 630 A for High-Feature applications

Technical specifications

The following technical information is intended to provide an initial overview of the various types of device and functions.

Detailed information, see

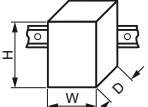
- Reference Manual "Protection Equipment – 3RU1, 3RB2 Overload Relays", <http://support.automation.siemens.com/WWW/view/en/35681297>
- or specific information on a particular article number via the product data sheet, <http://support.automation.siemens.com/WWW/view/en/20357046/133200>

Type – Overload relay: evaluation modules		3RB2283-4A.1	3RB2383-4A.1
Size contactor		S00 ... S10/S12	
Dimensions of evaluation modules (W x H x D)		45 x 111 x 95	
General data			
Trips in the event of		Overload, phase failure and phase unbalance (> 40 % according to NEMA), + ground fault (with corresponding function expansion module) and activation of the thermistor motor protection (with closed PTC sensor circuit)	
Trip class acc. to IEC 60947-4-1		CLASS 5, 10, 20 and 30 adjustable	
Phase failure sensitivity		Yes	
Overload warning		Yes, from $1.125 \times I_e$ for symmetrical loads and from $0.85 \times I_e$ for unsymmetrical loads	
Reset and recovery		Manual, automatic and remote RESET	
• Reset options after tripping			
• Recovery time			
- For automatic RESET	min.	- for tripping due to overcurrent: 3 (stored permanently) - for tripping by thermistor: time until the motor temperature has fallen 5 K below the response temperature	
- For manual RESET	min.	- for tripping due to a ground fault: no automatic RESET - for tripping due to overcurrent: 3 (stored permanently) - for tripping by thermistor: time until the motor temperature has fallen 5 K below the response temperature	
- For remote RESET	min.	- for tripping due to a ground fault: Immediately - for tripping due to overcurrent: 3 (stored permanently) - for tripping by thermistor: time until the motor temperature has fallen 5 K below the response temperature - for tripping due to a ground fault: Immediately	
Features			
• Display of operating state on device		Yes, with four LEDs: - green LED "Ready" - red LED "Ground Fault" - red LED "Thermistor" - red LED "Overload"	
• TEST function		Yes, test of LEDs, electronics, auxiliary contacts and wiring of control circuit by pressing the button TEST/RESET / self-monitoring	
• RESET button		Yes, with the TEST/RESET button	
• STOP button		No	
Protection and operation of explosion-proof motors			
EC type test certificate number according to directive 94/9/EC (ATEX)		PTB 05 ATEX 3022  II (2) GD, see http://support.automation.siemens.com/WWW/view/en/23115758	
Ambient temperatures			
• Storage/transport	°C	-40 ... +80	
• Operation	°C	-25 ... +60	
• Temperature compensation	°C	+60	
• Permissible rated current			
- Temperature inside control cabinet 60 °C	%	100	
- Temperature inside control cabinet 70 °C	%	On request	
Degree of protection acc. to IEC 60529		IP20: Current measuring modules in sizes S6 and S10/S12 with busbar connection in conjunction with cover.	
Touch protection acc. to IEC 61140		Finger-safe: Current measuring modules in sizes S6 and S10/S12 with busbar connection in conjunction with cover.	
Shock resistance with sine acc. to IEC 60068-2-27		g/ms	15/11
Electromagnetic compatibility (EMC) – Interference immunity			
• Conductor-related interference			
- Burst acc. to IEC 61000-4-4 (corresponds to degree of severity 3)	kV	2 (power ports), 1 (signal port)	
- Surge acc. to IEC 61000-4-5 (corresponds to degree of severity 3)	kV	2 (line to earth), 1 (line to line)	
• Electrostatic discharge according to IEC 61000-4-2 (corresponds to degree of severity 3)	kV	8 (air discharge), 6 (contact discharge)	
• Field-related interference according to IEC 61000-4-3 (corresponds to degree of severity 3)	V/m	10	
Electromagnetic compatibility (EMC) – emitted interference		Degree of severity A according to EN 55011 (CISPR 11) and EN 55022 (CISPR 22)	

Overload Relays

SIRIUS 3RB2 Electronic Overload Relays

3RB22, 3RB23 up to 630 A for High-Feature applications

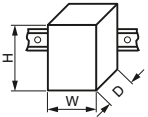

Type – Overload relay: evaluation modules			3RB2283-4A.1	3RB2383-4A.1
Size contactor			S00 ... S10/S12	
Dimensions of evaluation modules (W x H x D)			45 x 111 x 95	
General data (continued)				
Resistance to extreme climates – air humidity	%		100	
Dimensions			"Dimensional drawings", see <ul style="list-style-type: none"> Reference Manual "Protection Equipment – 3RU1, 3RB2 Overload Relays", http://support.automation.siemens.com/WW/view/en/35681297 Product data sheet, http://support.automation.siemens.com/WW/view/en/20357046/133200 	
Installation altitude above sea level	m		Up to 2 000	
Mounting position			Any	
Type of mounting			Stand-alone installation	
<ul style="list-style-type: none"> Evaluation modules Current measuring module 	Size		S00 to S3: Stand-alone installation, S6 and S10/S12: stand-alone installation or mounting onto contactors	
Type – Overload relay: evaluation modules			3RB2283-4A.1, 3RB2383-4A.1	
Size contactor			S00 ... S10/S12	
Auxiliary circuit				
Number of NO contacts			2	
Number of NC contacts			2	
Number of CO contacts			--	
Auxiliary contacts – assignment			<ul style="list-style-type: none"> Alternative 1 <ul style="list-style-type: none"> 1 NO for the signal "tripped by overload and/or thermistor" 1 NC for disconnecting the contactor 1 NO for the signal "tripped by ground fault" 1 NC for disconnecting the contactor or¹⁾ Alternative 2 <ul style="list-style-type: none"> 1 NO for the signal "tripped by overload and/or thermistor and/or ground fault" 1 NC for disconnecting the contactor 1 NO for overload warning 1 NC for disconnecting the contactor 	
Rated insulation voltage U_i (pollution degree 3)	V		300	
Rated impulse withstand voltage U_{imp}	kV		4	
Auxiliary contacts – contact rating				
<ul style="list-style-type: none"> NC contact with alternating current AC-14/AC-15, rated operational current I_e at U_e <ul style="list-style-type: none"> - 24 V - 120 V - 125 V - 250 V NO contact with alternating current AC-14/AC-15, rated operational current I_e at U_e <ul style="list-style-type: none"> - 24 V - 120 V - 125 V - 250 V NC contact, NO contact with direct current DC-13, rated operational current I_e at U_e <ul style="list-style-type: none"> - 24 V - 60 V - 110 V - 125 V - 250 V Conventional thermal current I_{th} Contact reliability (suitability for PLC control; 17 V, 5 mA) 	A		6 6 6 3 6 6 6 3 2 0.55 0.3 0.3 0.2 5 Yes	
Short-circuit protection				
<ul style="list-style-type: none"> With fuse, operational class gG With miniature circuit breaker, C characteristic 	A		6 1.6	
Protective separation between auxiliary current paths acc. to IEC 60947-1	V		300	
CSA, UL, UR rated data				
Auxiliary circuit – switching capacity			B300, R300	

¹⁾ The assignment of auxiliary contacts may be influenced by function expansion modules.

Overload Relays

SIRIUS 3RB2 Electronic Overload Relays

3RB22, 3RB23 up to 630 A for High-Feature applications

Type – Overload relay: evaluation modules		3RB2283-4A.1, 3RB2383-4A.1	
Size contactor		S00 ... S10/S12	
Control circuit			
Rated insulation voltage U_i (pollution degree 3)	V	300	
Rated impulse withstand voltage U_{imp}	kV	4	
Rated control supply voltage U_s			
• 50/60 Hz AC	V	24 ... 240	
• DC	V	24 ... 240	
Operating range			
• 50/60 Hz AC		$0.85 \times U_{s \min} \leq U_s \leq 1.1 \times U_{s \max}$	
• DC		$0.85 \times U_{s \min} \leq U_s \leq 1.1 \times U_{s \max}$	
Rated power			
• 50/60 Hz AC	W	0.5	
• DC	W	0.5	
Mains buffering time	ms	200	
Sensor circuit			
Thermistor motor protection (PTC thermistor sensor)			
• Summation cold resistance	k Ω	≤ 1.5	
• Response value	k Ω	3.4 ... 3.8	
• Return value	k Ω	1.5 ... 1.65	
Ground-fault detection			
The information refers to sinusoidal residual currents at 50/60 Hz.			
• Tripping value $I_{\Delta}^{(1)}$			
- For $0.3 \times I_e < I_{motor} < 2.0 \times I_e$		$> 0.3 \times I_e$	
- For $2.0 \times I_e < I_{motor} < 8.0 \times I_e$		$> 0.15 \times I_{motor}$	
• Response time t_{trip}	ms	500 ... 1 000	
Analog output¹⁾²⁾			
Rated values			
• Output signal	mA	4 ... 20	
• Measuring range		$0 \dots 1.25 \times I_e$ 4 mA corresponds to $0 \times I_e$ 16.8 mA corresponds to $1.0 \times I_e$ 20 mA corresponds to $1.25 \times I_e$	
• Load, max.	Ω	100	
Conductor cross-sections for the auxiliary, control and sensor circuit as well as the analog output			
Connection type		 Screw terminals	
Terminal screw		M3, Pozidriv size 2	
Operating devices	mm	3.0 x 0.5	
Prescribed tightening torque	Nm	0.8 ... 1.2	
Conductor cross-sections (min./max.), 1 or 2 conductors can be connected			
• Solid or stranded	mm ²	$1 \times (0.5 \dots 4)^3, 2 \times (0.5 \dots 2.5)^3$	
• Finely stranded without end sleeve	mm ²	--	
• Finely stranded with end sleeve (DIN 46228-1)	mm ²	$1 \times (0.5 \dots 2.5)^3, 2 \times (0.5 \dots 1.5)^3$	
• AWG cables, solid or stranded	AWG	$2 \times (20 \dots 14)$	
Connection type		 Spring-type terminals	
Operating devices	mm	3.0 x 0.5	
Conductor cross-sections (min./max.), 1 or 2 conductors can be connected			
• Solid or stranded	mm ²	$2 \times (0.25 \dots 1.5)$	
• Finely stranded without end sleeve	mm ²	--	
• Finely stranded with end sleeve (DIN 46228-1)	mm ²	$2 \times (0.25 \dots 1.5)$	
• AWG cables, solid or stranded	AWG	$2 \times (24 \dots 16)$	

1) For the 3RB22 and 3RB23 overload relays in combination with a corresponding function expansion module.

2) Analog input modules, e.g. SM 331, must be configured for 4-wire measuring transducers. In this case the analog input module must not supply current to the analog output of the 3RB22 and 3RB23 relay.

3) If two different conductor cross-sections are connected to one clamping point, both cross-sections must be in the range specified.

Overload Relays

SIRIUS 3RB2 Electronic Overload Relays

3RB22, 3RB23 up to 630 A for High-Feature applications

Selection and ordering data

Functions of the 3RB22 and 3RB23 evaluation modules in combination with the 3RB2985 function expansion modules

Evaluation modules	With function expansion module	Basic functions	Inputs		
			A1/A2	T1/T2	Y1/Y2
3RB2283-4AA1 3RB2283-4AC1 3RB2383-4AA1 3RB2383-4AC1	--	Inverse-time delayed protection, temperature-dependent protection, electrical remote RESET, overload warning	Power supply 24 ... 240 V AC/DC	Connection for PTC sensor	Electrical remote RESET
	3RB2985-2CA1	Inverse-time delayed protection, temperature-dependent protection, internal ground-fault detection, electrical remote RESET, overload warning	Power supply 24 ... 240 V AC/DC	Connection for PTC sensor	Electrical remote RESET
	3RB2985-2CB1	Inverse-time delayed protection, temperature-dependent protection, internal ground-fault detection, electrical remote RESET, ground-fault signal	Power supply 24 ... 240 V AC/DC	Connection for PTC sensor	Electrical remote RESET
	3RB2985-2AA0	Inverse-time delayed protection, temperature-dependent protection, electrical remote RESET, overload warning, analog output	Power supply 24 ... 240 V AC/DC	Connection for PTC sensor	Electrical remote RESET
	3RB2985-2AA1	Inverse-time delayed protection, temperature-dependent protection, internal ground-fault detection, electrical remote RESET, overload warning, analog output	Power supply 24 ... 240 V AC/DC	Connection for PTC sensor	Electrical remote RESET
	3RB2985-2AB1	Inverse-time delayed protection, temperature-dependent protection, internal ground-fault detection, electrical remote RESET, ground-fault signal, analog output	Power supply 24 ... 240 V AC/DC	Connection for PTC sensor	Electrical remote RESET

Evaluation modules	With function expansion module	Outputs				
		I (-) / I (+)	95/96 NC	97/98 NO	05/06 NC	07/08 NO
3RB2283-4AA1 3RB2283-4AC1 3RB2383-4AA1 3RB2383-4AC1	--	No	Disconnection of the contactor (inverse-time delayed/temperature-dependent protection)	Signal "tripped"	Overload warning	Overload warning
	3RB2985-2CA1	No	Disconnection of the contactor (inverse-time delayed/temperature-dependent protection + ground fault)	Signal "tripped"	Overload warning	Overload warning
	3RB2985-2CB1	No	Disconnection of the contactor (inverse-time delayed/temperature-dependent protection)	Signal "tripped"	Disconnection of the contactor (ground fault)	Signal "ground-fault tripping"
	3RB2985-2AA0	Analog signal	Disconnection of the contactor (inverse-time delayed/temperature-dependent protection)	Signal "tripped"	Overload warning	Overload warning
	3RB2985-2AA1	Analog signal	Disconnection of the contactor (inverse-time delayed/temperature-dependent protection + ground fault)	Signal "tripped"	Overload warning	Overload warning
	3RB2985-2AB1	Analog signal	Disconnection of the contactor (inverse-time delayed/temperature-dependent protection)	Signal "tripped"	Disconnection of the contactor (ground fault)	Signal "ground-fault tripping"

Overload Relays

SIRIUS 3RB2 Electronic Overload Relays

3RB22, 3RB23 up to 630 A for High-Feature applications

3RB22 and 3RB23 electronic overload relays (evaluation modules) for full motor protection, stand-alone installation, CLASS 5, 10, 20 and 30 (adjustable)

Type	3RB2283-4A.1, 3RB2383-4A.1
Features and technical specifications	
Overload protection, phase failure protection and unbalance protection	✓
Supplied from an external voltage	✓ 24 ... 240 V AC/DC
Auxiliary contacts	✓ 2 NO + 2 NC
Electrical remote RESET integrated	✓
Four LEDs for operating and status displays	✓
TEST function and self-monitoring	✓
Internal ground-fault detection	✓ (with function expansion module)
Screw or spring-type terminals for auxiliary, control and sensor circuits	✓
Input for PTC sensor circuit	✓
Analog output	✓ (with function expansion module)

✓ Available

PU (UNIT, SET, M) = 1
PS* = 1 unit
PG = 41G



3RB2283-4AA1,
3RB2383-4AA1



3RB2283-4AC1,
3RB2383-4AC1

Size contactor	Version	DT	Screw terminals	DT	Spring-type terminals	
			⊕		⊗	
			Article No.	Price per PU	Article No.	Price per PU
Evaluation modules						
S00 ... S12	Monostable	▶	3RB2283-4AA1	▶	3RB2283-4AC1	
	Bistable	▶	3RB2383-4AA1	▶	3RB2383-4AC1	

Note:

Overview of overload relays – matching contactors, see [page 7/93](#).

Current measuring modules and related connecting cables, see [page 7/152](#), general accessories, see [page 7/154 onwards](#).

Overload Relays

SIRIUS 3RB2 Electronic Overload Relays

3RB22, 3RB23 up to 630 A for High-Feature applications

Function expansion modules for 3RB22 and 3RB23 overload relays (evaluation modules)

Size contactor	Version	For overload relays	DT	Article No.	Price per PU	PU (UNIT, SET, M)	PS*	PG	
Sizes S00 to S12									
 3RB2985-2..1	S00 ... S12	For plugging into evaluation module (1 unit)							
		Analog Basic 1 modules¹⁾ Analog output DC 4 ... 20 mA, with overload warning	3RB22, 3RB23	▶	3RB2985-2AA0		1	1 unit	41F
		Analog Basic 1 GF modules¹⁾²⁾ Analog output DC 4 ... 20 mA, with internal ground-fault detection and overload warning	3RB22, 3RB23	▶	3RB2985-2AA1		1	1 unit	41F
		Analog Basic 2 GF modules¹⁾²⁾ Analog output DC 4 ... 20 mA, with internal ground-fault detection and overload ground-fault signaling	3RB22, 3RB23	▶	3RB2985-2AB1		1	1 unit	41F
		Basic 1 GF modules²⁾ with internal ground-fault detection and overload warning	3RB22, 3RB23	▶	3RB2985-2CA1		1	1 unit	41F
	Basic 2 GF modules²⁾ with internal ground-fault detection and ground-fault signaling	3RB22, 3RB23	▶	3RB2985-2CB1		1	1 unit	41F	

Note:

Analog input modules, e.g. SM 331, must be configured for 4-wire measuring transducers. In this case the analog input module must not supply current to the analog output of the 3RB22/3RB23 relay.

- 1) The analog signal DC 4 mA up to 20 mA can be used for operating rotary coil instruments or for feeding into analog inputs of programmable logic controllers.
- 2) The following information on ground-fault protection refers to sinusoidal residual currents at 50/60 Hz:
 - With a motor current of between 0.3 and 2 times the current setting I_e , the unit will trip at a ground-fault current equal to 30 % of the current setting.
 - With a motor current of between 2 and 8 times the current setting I_e , the unit will trip at a ground-fault current equal to 15 % of the current setting.
 - The response delay amounts to between 0.5 s and 1 s.

Overload Relays

SIRIUS 3RB2 Electronic Overload Relays

3RB24 for IO-Link, up to 630 A for High-Feature applications

Overview

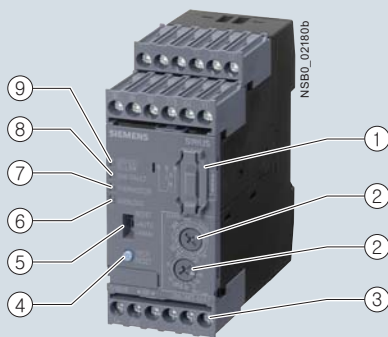

- ① Plug-in point for operator panel:
enables connection of the 3RA6935-0A operator panel.
- ② Motor current and trip class setting:
Setting the device to the motor current and to the required trip class dependent on the start-up conditions is easy with the two rotary switches.
- ③ Connecting terminals (removable terminal block):
The generously sized terminals permit connection of two conductors with different cross-sections for the auxiliary, control and sensor circuits. Connection is possible with screw connection and alternatively with spring-type connection.
- ④ Test/RESET button:
Enables testing of all important device components and functions, plus resetting of the device after a trip when manual RESET is selected.
- ⑤ Selector switch for manual/automatic RESET:
With this switch you can choose between manual and automatic RESET.
- ⑥ Red LED "OVERLOAD":
A continuous red light signals an active overload trip; a flickering led light signals an imminent trip (overload warning).
- ⑦ Red LED "THERMISTOR":
A continuous red light signals an active thermistor trip.
- ⑧ Red LED "GND FAULT":
A continuous red light signals an active ground-fault trip.
- ⑨ Green LED "DEVICE/IO-Link":
A continuous green light signals that the device is working correctly, a green flickering light signals the communication through IO-Link.

SIRIUS 3RB24 evaluation module

The modular 3RB24 electronic overload relay, which is powered via IO-Link (with monostable auxiliary contacts) up to 630 A (up to 820 A possible with a series transformer) have been designed for inverse-time delayed protection of loads with normal and heavy starting ("Function", [see Manual "SIRIUS 3RB24 Electronic Overload Relay for IO-Link", http://support.automation.siemens.com/WW/view/en/46165627](http://support.automation.siemens.com/WW/view/en/46165627)) against excessive temperature rises due to overload, phase unbalance or phase failure. It comprises an evaluation unit, a current measuring module and a connecting cable.

The evaluation module 3RB24 also offers an engine starter function: The contactors, which are connected via the auxiliary contacts, can also be actuated for operation via IO-Link. In this way, direct, reversing and wye-delta starters up to 630 A (or 830 A) can be connected to the controller wirelessly via the IO-Link controller.

An overload, phase unbalance or phase failure result in an increase of the motor current beyond the set rated motor current.

This current rise is detected by means of the current measuring module ([see page 7/152](#)) and electronically evaluated by the evaluation module which is connected to it. The evaluation electronics sends a signal to the auxiliary contacts. The auxiliary contacts then switch off the load by means of a contactor.

The break time depends on the ratio between the tripping current and current setting I_b and is stored in the form of a long-term stable tripping characteristic ([see "Characteristic Curves", http://support.automation.siemens.com/WW/view/en/20357046/134300](http://support.automation.siemens.com/WW/view/en/20357046/134300)). The "tripped" status is signaled by means of a continuously illuminated red "OVERLOAD" LED and also reported as a group fault via IO-Link.

The LED indicates imminent tripping of the relay due to overload, phase unbalance or phase failure by flickering when the limit current has been violated. This warning can also be reported to the higher-level PLC via IO-Link at the 3RB24 overload relay.

In addition to the described inverse-time delayed protection of loads against excessive temperature rises, the 3RB24 electronic overload relays also allow direct temperature monitoring of the motor windings (full motor protection) by connection with broken-wire interlock of a PTC sensor circuit. With this temperature-dependent protection, the loads can be protected against overheating caused indirectly by reduced coolant flow, for example, which cannot be detected by means of the current alone. In the event of overheating, the devices switch off the contactor, and thus the load, by means of the auxiliary contacts. The "tripped" status is signaled by means of a continuously illuminated "THERMISTOR" LED and also reported as a group fault via IO-Link.

To protect the loads against incomplete ground faults due to damage to the insulation, humidity, condensed water, etc., the 3RB24 electronic overload relays offer the possibility of internal ground-fault detection (for details, [see Manual "SIRIUS 3RB24 Solid-State Overload Relay for IO-Link", http://support.automation.siemens.com/WW/view/en/46165627](http://support.automation.siemens.com/WW/view/en/46165627), not possible in conjunction with contactor assemblies for wye-delta starting). In the event of a ground fault, the 3RB24 relays trip instantaneously.

The "tripped" status is signaled by means of a flashing red LED "Ground Fault" and reported at the overload relay 3RB24 as a group fault via IO-Link.

The reset after overload, phase unbalance, phase failure, thermistor or ground-fault tripping is performed manually by key on site, via IO-Link or by electrical remote RESET or automatically after the cooling time (motor model) or for thermistor protection after sufficient cooling. Power cuts in devices due to function monitors (broken wire or short-circuit on the thermistor) can only be reset on-site ("Function", [see Manual "SIRIUS 3RB24 Solid-State Overload Relay for IO-Link", http://support.automation.siemens.com/WW/view/en/46165627](http://support.automation.siemens.com/WW/view/en/46165627)).

In conjunction with a function expansion module, the motor current measured by the microprocessor can be output in the form of an analog signal DC 4 to 20 mA for operating rotary coil instruments or for feeding into analog inputs of programmable logic controllers.

The current values can be transmitted to the higher-level controller via IO-Link.

The 3RB24 electronic overload relay for IO-Link is suitable for operation with frequency converters. Please follow the instructions in the manual "SIRIUS 3RB24 Solid-State Overload Relay for IO-Link", [see http://support.automation.siemens.com/WW/view/en/46165627](http://support.automation.siemens.com/WW/view/en/46165627).

The devices are manufactured in accordance with environmental guidelines and contain environmentally friendly and reusable materials. They comply with all important worldwide standards and approvals.

Overload Relays

SIRIUS 3RB2 Electronic Overload Relays

3RB24 for IO-Link, up to 630 A for High-Feature applications

Use in hazardous areas

The 3RB24 electronic overload relays for IO-Link with the 3RB29 current measuring module are suitable for the overload protection of motors with the following types of protection:

- II (2) G [Ex e] [Ex d] [Ex px]
- II (2) D [Ex t] [Ex p]

EC type test certificate for Group II, Category (2) G/D exists. It has the number PTB 11 ATEX 3014.

Article No. scheme

Digit of the Article No.	1st - 3rd	4th	5th	6th	7th	8th	9th	10th	11th	
Electronic overload relays	<input type="checkbox"/>	<input type="checkbox"/>	<input type="checkbox"/>	<input type="checkbox"/>	<input type="checkbox"/>	-	<input type="checkbox"/>	<input type="checkbox"/>	<input type="checkbox"/>	<input type="checkbox"/>
SIRIUS 2nd generation	3 R B									
Device series		2								
Size, rated operational current and power			<input type="checkbox"/>							
Version of the automatic RESET, electrical remote RESET				<input type="checkbox"/>						
Trip class (CLASS)							<input type="checkbox"/>			
Setting range of the overload release								<input type="checkbox"/>		
Connection methods									<input type="checkbox"/>	
Installation type										<input type="checkbox"/>
Example	3 R B	2	4	8	3	-	4	A	A	1

Note:

The Article No. scheme is presented here merely for information purposes and for better understanding of the logic behind the article numbers.

For your orders, please use the article numbers quoted in the catalog in the Selection and ordering data.

Benefits

The most important features and benefits of the 3RB24 electronic overload relays for IO-Link are listed in the overview table (see "General Data", page 7/87 onwards).

Advantages through energy efficiency

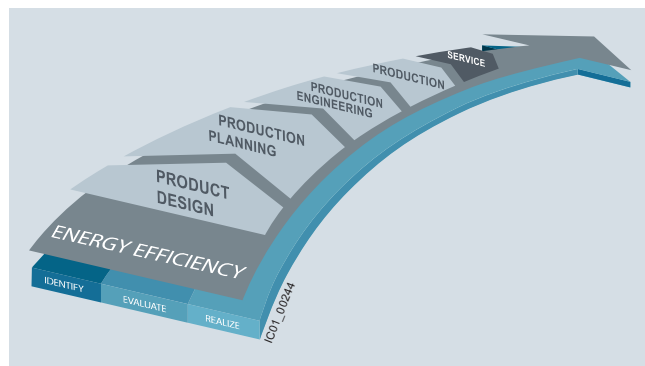

Overview of the energy management process

We offer you a unique portfolio for industrial energy management, using an energy management system that helps to optimally define your energy needs. We split up our industrial energy management into three phases – identify, evaluate, and realize – and we support you with the appropriate hardware and software solutions in every process phase.

The innovative products of the SIRIUS industrial controls portfolio can also make a substantial contribution to a plant's energy efficiency (see www.siemens.com/sirius/energysaving).

3RB24 electronic overload relays for IO-Link contribute to energy efficiency throughout the plant as follows:

- Transmission of current values
- Reduced inherent power loss
- Less heating of the control cabinet
- Smaller control cabinet air conditioners can be used

Application

Industries

The 3RB24 electronic overload relays are suitable for customers from all industries who want to guarantee optimum inverse-time delayed and temperature-dependent protection of their electrical loads (e.g. motors) under normal and heavy starting conditions (CLASS 5 to 30), minimize project completion times, inventories and energy consumption, and optimize plant availability and maintenance management.

Application

The 3RB24 electronic overload relays have been designed for the protection of three-phase asynchronous and single-phase AC motors.

In addition to protection function, these devices can be used together with contactors as direct or reversing starters (star-delta (wye-delta) start also possible), which are controlled via IO-Link. This makes it possible to directly control drives via IO-Link from a higher-level controller or on site via the optional

hand-held device lamps and also, for example, to return current values directly via IO-Link.

If single-phase AC motors are to be protected by the 3RB24 electronic overload relays, the main current paths of the current measuring modules must be series-connected ("Circuit Diagrams", see Manual "SIRIUS 3RB24 Solid-State Overload Relay for IO-Link", <http://support.automation.siemens.com/WW/view/en/46165627>).

Ambient conditions

The devices are insensitive to external influences such as shocks, corrosive ambient conditions, ageing and temperature fluctuations.

For the temperature range from -25 °C to +60 °C, the 3RB24 electronic overload relays compensate the temperature in accordance with IEC 60947-4-1.

Configuration notes for use of the devices below -25 °C or above +60 °C on request.

Overload Relays

SIRIUS 3RB2 Electronic Overload Relays

3RB24 for IO-Link, up to 630 A for High-Feature applications

Technical specifications

The following technical information is intended to provide an initial overview of the various types of device and functions.

Detailed information, see

- Manual "SIRIUS 3RB24 Solid-State Overload Relay for IO-Link", <http://support.automation.siemens.com/WW/view/en/46165627>
- or specific information on a particular article number via the product data sheet, <http://support.automation.siemens.com/WW/view/en/20357046/133200>

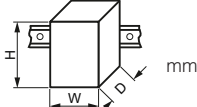
Type – Overload relay: evaluation modules			3RB2483-4A.1
Size contactor			S00 ... S10/S12
Dimensions of evaluation modules (W x H x D)		mm	45 x 111 x 95
General data			
Trips in the event of			Overload, phase failure and phase unbalance (> 40 % according to NEMA), + ground fault (connectable and disconnectable) and activation of the thermistor motor protection (with closed PTC sensor circuit)
Trip class acc. to IEC 60947-4-1			CLASS 5, 10, 20 and 30 adjustable
Phase failure sensitivity			Yes
Overload warning			Yes, from $1.125 \times I_e$ for symmetrical loads and from $0.85 \times I_e$ for unsymmetrical loads
Reset and recovery			Manual and automatic RESET, electrical remote RESET or through IO-Link
• Reset options after tripping			
• Recovery time			
- For automatic RESET	min.		- for tripping due to overcurrent: 3 (stored permanently) - for tripping by thermistor: time until the motor temperature has fallen 5 K below the response temperature - for tripping due to a ground fault: no automatic RESET
- For manual RESET	min.		- for tripping due to overcurrent: 3 (stored permanently) - for tripping by thermistor: time until the motor temperature has fallen 5 K below the response temperature - for tripping due to a ground fault: Immediately
- For remote RESET	min.		- for tripping due to overcurrent: 3 (stored permanently) - for tripping by thermistor: time until the motor temperature has fallen 5 K below the response temperature - for tripping due to a ground fault: Immediately
Features			
• Display of operating state on device			Yes, with 4 LEDs: - Green "DEVICE/IO-Link" LED - Red LED "Ground Fault" - Red LED "Thermistor" - Red "Overload" LED
• TEST function			Yes, test of LEDs, electronics, auxiliary contacts and wiring of control circuit by pressing the button TEST/RESET / self-monitoring
• RESET button			Yes, with the TEST/RESET button
• STOP button			No
Protection and operation of explosion-proof motors			
EC type test certificate number according to directive 94/9/EC (ATEX)			PTB 11 ATEX 3014 ⊕ II (2) G [Ex e] [Ex d] [Ex px] ⊕ II (2) G [Ex t] [Ex p], see http://support.automation.siemens.com/WW/view/en/60524083
Ambient temperatures			
• Storage/transport	°C		-40 ... +80
• Operation	°C		-25 ... +60
• Temperature compensation	°C		+60
• Permissible rated current			
- Temperature inside control cabinet 60 °C	%		100
- Temperature inside control cabinet 70 °C	%		On request
Degree of protection acc. to IEC 60529			IP20: Current measuring modules in sizes S6 and S10/S12 with busbar connection in conjunction with the cover
Touch protection acc. to IEC 61140			Finger-safe: Current measuring modules in sizes S6 and S10/S12 with busbar connection in conjunction with the cover
Shock resistance with sine acc. to IEC 60068-2-27		g/ms	15/11

Overload Relays

SIRIUS 3RB2 Electronic Overload Relays

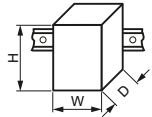

3RB24 for IO-Link, up to 630 A for High-Feature applications

Type – Overload relay: evaluation modules			3RB2483-4A.1
Size contactor			S00 ... S10/S12
Dimensions of evaluation modules (W x H x D)		mm	45 x 111 x 95
General data (continued)			
Electromagnetic compatibility (EMC) – Interference immunity			
• Conductor-related interference			
- Burst acc. to IEC 61000-4-4 (corresponds to degree of severity 3)	kV		2 (power ports), 1 (signal ports)
- Surge acc. to IEC 61000-4-5 (corresponds to degree of severity 3)	kV		2 (line to earth), 1 (line to line)
• Electrostatic discharge according to IEC 61000-4-2 (corresponds to degree of severity 3)	kV		8 (air discharge), 6 (contact discharge)
• Field-related interference according to IEC 61000-4-3 (corresponds to degree of severity 3)	V/m		10
Electromagnetic compatibility (EMC) – emitted interference		Degree of severity A according to EN 55011 (CISPR 11) and EN 55022 (CISPR 22)	
Resistance to extreme climates – air humidity	%	100	
Dimensions		"Dimensional drawings", see • Manual "SIRIUS 3RB24 Solid-State Overload Relay for IO-Link", http://support.automation.siemens.com/WW/view/en/46165627 • Product data sheet, http://support.automation.siemens.com/WW/view/en/20357046/133200	
Installation altitude above sea level	m	Up to 2 000	
Mounting position		Any	
Type of mounting			
• Evaluation modules		Stand-alone installation	
• Current measuring module	Size	S00 to S3: Stand-alone installation, S6 and S10/S12: stand-alone installation or mounting onto contactors	

Overload Relays

SIRIUS 3RB2 Electronic Overload Relays

3RB24 for IO-Link, up to 630 A for High-Feature applications



Type – Overload relay: evaluation modules	3RB2483-4A.1	
Size contactor	S00 ... S10/S12	
Auxiliary circuit		
Number of auxiliary switches	1 CO contact, 1 NO contact connected in series internally	
Auxiliary contacts – assignment	<ul style="list-style-type: none"> • 1 CO contact for selecting the contactor (for reversing starter function), actuated by the control system • 1 NO contact for normal switching duty, actuated by the control system (opens automatically when tripping occurs) 	
Rated insulation voltage U_i (pollution degree 3)	V	300
Rated impulse withstand voltage U_{imp}	kV	4
Auxiliary contacts – contact rating		
<ul style="list-style-type: none"> • NC contact with alternating current AC-14/AC-15, rated operational current I_e at U_e <ul style="list-style-type: none"> - 24 V - 120 V - 125 V - 250 V • NO contact with alternating current AC-14/AC-15, rated operational current I_e at U_e <ul style="list-style-type: none"> - 24 V - 120 V - 125 V - 250 V • NC contact, NO contact with direct current DC-13, rated operational current I_e at U_e <ul style="list-style-type: none"> - 24 V - 60 V - 110 V - 125 V - 250 V • Conventional thermal current I_{th} • Contact reliability (suitability for PLC control; 17 V, 5 mA) 	A	6 6 6 3 6 6 6 3 2 0.55 0.3 0.3 0.2 5 Yes
Short-circuit protection		
<ul style="list-style-type: none"> • With fuse, operational class gG • With miniature circuit breaker, C characteristic 	A	6 1.6
Protective separation between auxiliary current paths acc. to IEC 60947-1	V	300
CSA, UL, UR rated data		
Auxiliary circuit – switching capacity	B300, R300	
Conductor cross-sections of the auxiliary circuit		
Connection type	 Screw terminals	
Terminal screw	M3, Pozidriv size 2	
Operating devices	mm	3.0 x 0.5
Prescribed tightening torque	Nm	0.8 ... 1.2
Conductor cross-sections (min./max.), 1 or 2 conductors can be connected		
• Solid or stranded	mm ²	1 x (0.5 ... 4) ¹⁾ , 2 x (0.5 ... 2.5) ¹⁾
• Finely stranded without end sleeve	mm ²	–
• Finely stranded with end sleeve (DIN 46228-1)	mm ²	1 x (0.5 ... 2.5) ¹⁾ , 2 x (0.5 ... 1.5) ¹⁾
• AWG cables, solid or stranded	AWG	2 x (20 ... 14)
Connection type	 Spring-type terminals	
Operating devices	mm	3.0 x 0.5
Conductor cross-sections (min./max.), 1 or 2 conductors can be connected		
• Solid or stranded	mm ²	2 x (0.25 ... 1.5)
• Finely stranded without end sleeve	mm ²	–
• Finely stranded with end sleeve (DIN 46228-1)	mm ²	2 x (0.25 ... 1.5)
• AWG cables, solid or stranded	AWG	2 x (24 ... 16)

¹⁾ If two different conductor cross-sections are connected to one clamping point, both cross-sections must be in the range specified.

Overload Relays

SIRIUS 3RB2 Electronic Overload Relays

3RB24 for IO-Link, up to 630 A for High-Feature applications

Type – Overload relay: evaluation modules		3RB2483-4A.1
Size contactor		S00 ... S10/S12
Control circuit		
Rated insulation voltage U_i (pollution degree 3)	V	300
Rated impulse withstand voltage U_{imp}	kV	4
Rated control supply voltage $U_s^{(1)}$		
• DC	V	24 through IO-Link
Operating range		
• DC		$0.85 \times U_{s \min} \leq U_s \leq 1.1 \times U_{s \max}$
Rated power		
• DC	W	0.5
Mains buffering time		
	ms	200
Sensor circuit		
Thermistor motor protection (PTC thermistor sensor)		
• Summation cold resistance	k Ω	≤ 1.5
• Response value	k Ω	3.4 ... 3.8
• Return value	k Ω	1.5 ... 1.65
Ground-fault detection		
• Tripping value I_s		The information refers to sinusoidal residual currents at 50/60 Hz.
- For $0.3 \times I_e < I_{motor} < 2.0 \times I_e$		$> 0.3 \times I_e$
- For $2.0 \times I_e < I_{motor} < 8.0 \times I_e$		$> 0.15 \times I_{motor}$
• Response time t_{trip}	ms	500 ... 1 000
Analog output⁽¹⁾		
Rated values		
• Output signal	mA	4 ... 20
• Measuring range		$0 \dots 1.25 \times I_e$ 4 mA corresponds to $0 \times I_e$ 16.8 mA corresponds to $1.0 \times I_e$ 20 mA corresponds to $1.25 \times I_e$
• Load, max.	Ω	100
Conductor cross-sections for the control and sensor circuit as well as the analog output		
Connection type		 Screw terminals
Terminal screw		M3, Pozidriv size 2
Operating devices		mm 3.0 x 0.5
Prescribed tightening torque		Nm 0.8 ... 1.2
Conductor cross-sections (min./max.), 1 or 2 conductors can be connected		
• Solid	mm ²	$1 \times (0.5 \dots 4)^2, 2 \times (0.5 \dots 2.5)^2$
• Finely stranded without end sleeve	mm ²	--
• Finely stranded with end sleeve (DIN 46228-1)	mm ²	$1 \times (0.5 \dots 2.5)^2, 2 \times (0.5 \dots 1.5)^2$
• Stranded	mm ²	--
• AWG cables, solid or stranded	AWG	$2 \times (20 \dots 14)$
Connection type		 Spring-type terminals
Operating devices		mm 3.0 x 0.5
Conductor cross-sections (min./max.), 1 or 2 conductors can be connected		
• Solid	mm ²	$2 \times (0.25 \dots 1.5)$
• Finely stranded without end sleeve	mm ²	--
• Finely stranded with end sleeve (DIN 46228-1)	mm ²	$2 \times (0.25 \dots 1.5)$
• Stranded	mm ²	$2 \times (0.25 \dots 1.5)$
• AWG cables, solid or stranded	AWG	$2 \times (24 \dots 16)$

¹⁾ Analog input modules, e.g. SM 331, must be configured for 4-wire measuring transducers. The analog input module may not supply current to the analog output of the 3RB24 overload relay.

²⁾ If two different conductor cross-sections are connected to one clamping point, both cross-sections must be in the range specified.

Overload Relays

SIRIUS 3RB2 Electronic Overload Relays

3RB24 for IO-Link, up to 630 A for High-Feature applications

Selection and ordering data

3RB24 electronic overload relays (evaluation modules) for full motor protection, stand-alone installation, CLASS 5, 10, 20 and 30 (adjustable)

Type	3RB2483-4A.1
Features and technical specifications	
Overload protection, phase failure protection and unbalance protection	✓
Supplied from an external voltage	✓ 24 V DC through IO-Link
Direct-on-line or reversing starters (wye-delta starting also possible) controllable through IO-Link	✓
Auxiliary contacts	✓ 1 CO and 1 NO in series
Manual and automatic RESET	✓
Remote RESET	✓ (electrically or via IO-Link)
Four LEDs for operating and status displays	✓
TEST function and self-monitoring	✓
Internal ground-fault detection	✓
Screw or spring-type terminals for auxiliary, control and sensor circuits	✓
Input for PTC sensor circuit	✓
Analog output	✓
IO-Link-specific functions	
• Connection of direct-on-line, reversing and star-delta starters to the controller via IO-Link	✓
• On-site controlling of the starter using the hand-held device	✓
• Accessing process data (e.g. current values in all three phases) via IO-Link	✓
• Accessing parameterization and diagnostics data (e.g. tripped signals) via IO-Link	✓

✓ Available

PU (UNIT, SET, M) = 1
PS* = 1 unit
PG = 41G



3RB2483-4AA1



3RB2483-4AC1

Size contactor	Version	DT	Screw terminals	DT	Spring-type terminals	
			⊕		⊕	
			Article No.	Price per PU	Article No.	Price per PU

Evaluation modules

S00 ... S12	Monostable	DT	3RB2483-4AA1	A	3RB2483-4AC1

Notes:

- Overview of overload relays – matching contactors, see [page 7/93](#).
- Analog input modules, e.g. SM 331, must be configured for 4-wire measuring transducers. The analog input module may not supply current to the analog output of the 3RB24 relay.

Current measuring modules and related connecting cables, see [page 7/152 onwards](#), "Accessories", see [page 7/153 onwards](#).

Overload Relays

SIRIUS 3RB2 Electronic Overload Relays

Current measuring modules for 3RB22, 3RB23, 3RB24

Overview



SIRIUS 3RB2906 current measuring module

The current measuring modules are designed as system components for connecting to evaluation units 3RB22 to 3RB24. Using these evaluation units the motor current is measured and the measured value sent to the evaluation unit for evaluation.

The current measuring modules in sizes up to S3 are equipped with straight-through transformers and can be snap-fitted under the evaluation units. The larger evaluation units are installed directly on the contactor or as stand-alone units.

Technical specifications

The following technical information is intended to provide an initial overview of the various types of device and functions.

Detailed information, see Reference Manual "Protection Equipment - Overload Relays 3RU1, 3RB2", <http://support.automation.siemens.com/WW/view/en/35681297>

Type – Overload relays: Current measuring modules

Size contactor

Dimensions of current measuring modules (W x H x D)

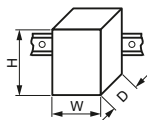

Main circuit

Rated insulation voltage U_i
(pollution degree 3)

V

1 000

Rated impulse withstand voltage U_{imp}

kV

6

8

Rated operational voltage U_e

V

1 000

Type of current

- Direct current
- Alternating current

No

Yes, 50/60 Hz \pm 5 %

Current setting

A

0.3 ... 3;
2.4 ... 25

10 ... 100

20 ... 200

63 ... 630

Power loss per unit (max.)

W

0.5

Short-circuit protection

- With fuse without contactor
- With fuse and contactor

See "Selection and ordering data" on page 7/152

See configuration manuals

- "Configuring SIRIUS Innovations – Selection Data for Fuseless and Fused Load Feeders", <http://support.automation.siemens.com/WW/view/en/50250039>
- "SIRIUS Configuration – Selection Data for Fuseless Load Feeders", <http://support.automation.siemens.com/WW/view/en/68115041>

Protective separation between main and auxiliary current paths

acc. to IEC 60947-1 (pollution degree 2)

- For systems with grounded neutral point
- For systems with ungrounded neutral point

V

690



V

600

Overload Relays

SIRIUS 3RB2 Electronic Overload Relays

Current measuring modules for 3RB22, 3RB23, 3RB24

Type – Overload relays: Current measuring modules		3RB2906		3RB2956		3RB2966	
Size contactor		S00/S0		S2/S3		S6	
Dimensions of current measuring modules (W x H x D)		45 x 84 x 45		55 x 94 x 72		120 x 119 x 145	
		mm		mm		mm	
Conductor cross-sections of main circuit							
Connection type		 Screw terminals with box terminal					
Terminal screw	mm	--	--	4 mm Allen screw		5 mm Allen screw	
Operating devices	mm	--	--	4 mm Allen screw		5 mm Allen screw	
Prescribed tightening torque	Nm	--	--	10 ... 12		20 ... 22	
Conductor cross-sections (min./max.), 1 or 2 conductors can be connected							
• Solid or stranded		mm ²	--	With 3RT1955-4G box terminal: 2 x (max. 70), 1 x (16 ... 70)		2 x (70 ... 240), Rear clamping point only: 1 x (95 ... 300)	
• Finely stranded without end sleeve		mm ²	--	With 3RT1956-4G box terminal: 2 x (max. 120), 1 x (16 ... 120)		Rear clamping point only: 1 x (120 ... 240)	
• Finely stranded with end sleeve (DIN 46228-1)		mm ²	--	With 3RT1955-4G box terminal: 2 x (1 x max. 50, 1 x max. 70), 1 x (10 ... 70)		2 x (50 ... 185), Rear clamping point only: 1 x (70 ... 240)	
• AWG cables		AWG	--	With 3RT1956-4G box terminal: 2 x (1 x max. 95, 1 x max. 120), 1 x (10 ... 120)		Rear clamping point only: 1 x (120 ... 185)	
• Ribbon cables (Number x Width x Thickness)		mm	--	With 3RT1955-4G box terminal: 2 x (1 x max. 50, 1 x max. 70), 1 x (10 ... 70)		2 x (50 ... 185), Rear clamping point only: 1 x (70 ... 240)	
				With 3RT1956-4G box terminal: 2 x (1 x max. 95, 1 x max. 120), 1 x (10 ... 120)		Rear clamping point only: 1 x (120 ... 185)	
				With 3RT1955-4G box terminal: 2 x (max. 1/0), 1 x (6 ... 2/0)		2 x (2/0 ... 500 kcmil), rear clamping point only: 1 x (3/0 ... 600 kcmil)	
				With 3RT1956-4G box terminal: 2 x (max. 3/0), 1 x (6 ... 250 kcmil)		Rear clamping point only: 1 x (250 kcmil ... 500 kcmil)	
				With 3RT1955-4G box terminal: 2 x (6 x 15.5 x 0.8), 1 x (3 x 9 x 0.8 ... 6 x 15.5 x 0.8)		2 x (20 x 24 x 0.5), 1 x (6 x 9 x 0.8 ... 20 x 24 x 0.5)	
				With 3RT1956-4G box terminal: 2 x (10 x 15.5 x 0.8), 1 x (3 x 9 x 0.8 ... 10 x 15.5 x 0.8)			
Connection type		 Busbar connections					
Terminal screw		--	--	M8 x 25		M10 x 30	
Prescribed tightening torque	Nm	--	--	10 ... 14		14 ... 24	
Conductor cross-sections (min./max.), 1 or 2 conductors can be connected							
• Solid with cable lug		mm ²	--	16 ... 95 ¹⁾		50 ... 240 ²⁾	
• Stranded with cable lug		mm ²	--	25 ... 120 ¹⁾		70 ... 240 ²⁾	
• AWG cables, solid or stranded, with cable lug		AWG	--	4 ... 250 kcmil		2/0 ... 500 kcmil	
• With connecting bars (max. width)		mm	--	17		25	
Connection type		 Straight-through transformers					
Diameter of opening	mm	7.5	14	25	--		

¹⁾ When connecting cable lugs according to DIN 46235 with conductor cross-sections of 95 mm² and more, the 3RT1956-4EA1 terminal cover must be used to ensure phase clearance.

²⁾ When connecting cable lugs according to DIN 46234 with conductor cross-sections of 240 mm² and more as well as to DIN 46235 with conductor cross-sections of 185 mm² and more, the 3RT1956-4EA1 terminal cover must be used to ensure the phase clearance.

Overload Relays

SIRIUS 3RB2 Electronic Overload Relays

Current measuring modules for 3RB22, 3RB23, 3RB24

Selection and ordering data

Current measuring modules (essential accessory)



3RB2906-2BG1,
3RB2906-2DG1



3RB2906-2JG1



3RB2956-2TG2



3RB2966-2WH2

Size contactor	Current setting value of the inverse-time delayed overload release	Short-circuit protection with fuse, type of coordination "2", operational class gG ¹⁾	For overload relays	DT	Article No.	Price per PU	PU (UNIT, SET, M)	PS*	PG
Sizes S00/S0									
Devices with straight-through transformer, for stand-alone installation									
S00/S0	0.3 ... 3 2.4 ... 25	20 63	3RB22 to 3RB24	▶	3RB2906-2BG1 3RB2906-2DG1		1 1	1 unit 1 unit	41G 41G
Sizes S2/S3									
Devices with straight-through transformer, for stand-alone installation									
S2/S3	10 ... 100	315	3RB22 to 3RB24	▶	3RB2906-2JG1		1	1 unit	41G
Size S6									
Devices with busbar connection, for mounting onto contactor and stand-alone installation									
S6	20 ... 200	315	3RB22 to 3RB24	▶	3RB2956-2TH2		1	1 unit	41G
Devices with straight-through transformer, for mounting onto contactor and stand-alone installation									
For mounting onto S6 con- tactors with box terminals	20 ... 200	315	3RB22 to 3RB24	▶	3RB2956-2TG2		1	1 unit	41G
Sizes S10/S12²⁾									
Devices with busbar connection, for mounting onto contactor and stand-alone installation									
S10/S12 and size 14 (3TF68/3TF69) ²⁾	63 ... 630	800	3RB22 to 3RB24	▶	3RB2966-2WH2		1	1 unit	41G

Note:

The connecting cable between the current measuring module and the evaluation module is not included in the scope of supply; please order separately (see "Accessories").

- ¹⁾ Maximum protection by fuse only for overload relay, type of coordination "2". For fuse values in connection with contactors, see Configuration Manuals
- "Configuring SIRIUS Innovations – Selection Data for Fuseless and Fused Load Feeders", <http://support.automation.siemens.com/WW/view/en/39714188>
 - "SIRIUS Configuration – Selection Data for Fuseless Load Feeders", <http://support.automation.siemens.com/WW/view/en/40625241>.

- ²⁾ For 3TF68/3TF69 contactors, direct mounting is not possible.

Accessories

Size contactor	Version	For overload relays	DT	Article No.	Price per PU	PU (UNIT, SET, M)	PS*	PG	
Connecting cables (necessary accessories)									
 3RB2987-2.	S00 ... S3	For connection between evaluation module and current measuring module	3RB24, 3RB29	▶	3RB2987-2B		1	1 unit	41F
	S00 ... S12	• Length 0.1 m (only for mounting of the evaluation module directly onto the current measuring module)	3RB24, 3RB29	▶	3RB2987-2D		1	1 unit	41F

Additional general accessories, see page 7/154.

Overview

Overload relays for High-Feature applications

The following optional accessories are available for the 3RB22 to 3RB24 electronic overload relays:

- Operator panel for the evaluation modules 3RB24
- Manuals, see "More information"
- Sealable cover for the evaluation modules 3RB22 to 3RB24
- Terminal covers for the 3RB29 current measuring modules size S6 and S10/S12
- Box terminal blocks for the 3RB29 current measuring modules size S6 and S10/S12
- Push-in lugs for screw fixing for 3RB22 to 3RB24 evaluation modules and 3RB2906 current measuring modules

Selection and ordering data

Accessories for 3RB24 overload relays

Version	For overload relays	DT	Article No.	Price per PU	PU (UNIT, SET, M)	PS*	PG
Operator panels for evaluation modules							
 <p>3RA6935-0A</p>	Operator panels (set)	3RB24	A	3RA6935-0A	1	1 unit	42F
	One set comprises: <ul style="list-style-type: none"> • 1 x operator panel • 1 x 3RA6936-0A enabling module • 1 x 3RA6936-0B interface cover • 1 x fixing terminal Note: The connecting cable between the evaluation module and the operator panel is not included in the scope of supply; please order separately.						
	Connecting cable	3RB24	▶	3UF7933-0BA00-0	1	1 unit	42J
	Enabling modules (replacement)	3RB24	A	3RA6936-0A	1	1 unit	42F
Interface covers	3RB24	A	3RA6936-0B	1	5 units	42F	

Additional general accessories, see next page.

More information

Manuals









- System Manual "SIRIUS Innovations – System Overview"
<http://support.automation.siemens.com/WW/view/en/60311318>
- Manual "SIRIUS 3RB24 Solid-State Overload Relay for IO-Link"
<http://support.automation.siemens.com/WW/view/en/46165627>

Overload Relays

SIRIUS 3RB2 Electronic Overload Relays

Accessories for 3RB22, 3RB23, 3RB24

General accessories

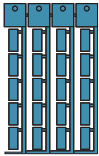
Version	Size	For overload relays	DT	Article No.	Price per PU	PU (UNIT, SET, M)	PS*	PG	
Sealable covers for evaluation modules									
	For covering the setting knobs	--	3RB22 to 3RB24	▶	3RB2984-2		1 10 units	41F	
3RB2984-2									
Terminal covers for current measuring modules									
Covers for cable lugs and busbar connections									
	• Length 100 mm	S6	3RB2956	▶	3RT1956-4EA1		1 1 unit	41B	
	• Length 120 mm	S10/S12	3RB2966	▶	3RT1966-4EA1		1 1 unit	41B	
Covers for box terminals									
3RT1956-4EA1	• Length 25 mm	S6	3RB2956	▶	3RT1956-4EA2		1 1 unit	41B	
	• Length 30 mm	S10/S12	3RB2966	▶	3RT1966-4EA2		1 1 unit	41B	
Covers for screw terminals between contactor and overload relay, without box terminals (1 unit required per combination)									
		S6	3RB2956	▶	3RT1956-4EA3		1 1 unit	41B	
		S10/S12	3RB2966	▶	3RT1966-4EA3		1 1 unit	41B	
3RT1956-4EA2									
Box terminal blocks for current measuring modules									
	For round and ribbon cables								
	• Up to 70 mm ²	S6 ¹⁾	3RB2956	▶	3RT1955-4G		1 1 unit	41B	
	• Up to 120 mm ²	S6	3RB2956	▶	3RT1956-4G		1 1 unit	41B	
	• Up to 240 mm ²	S10/S12	3RB2966	▶	3RT1966-4G		1 1 unit	41B	
For technical specifications for conductor cross-sections, see Reference Manual "Protection Equipment – 3RU1, 3RB2 Overload Relays", http://support.automation.siemens.com/WWW/view/en/35681297 .									
3RT195-4G									
Push-in lugs for evaluation modules and current measuring modules									
	For screw fixing the evaluation modules	--	3RB22 to 3RB24	B	3RP1903		1 10 units	41H	
	3RP1903								
	For screw fixing the current measuring modules (2 units per module)	S00 ... S3	3RB2906	A	3RB1900-0B		100 10 units	41F	
	3RB1900-0B								
1) In the scope of supply for 3RT1054-1 contactors (55 kW).									
Version	Size	Color	For overload relays	DT	Article No.	Price per PU	PU (UNIT, SET, M)	PS*	PG
Tools for opening spring-type terminals									
	Screwdrivers For all SIRIUS devices with spring-type terminals	Length approx. 200 mm, 3.0 mm x 0.5 mm	Titanium gray/black, partially insulated	Main and auxiliary circuit connection: 3RB2	A	Spring-type terminals 		1 1 unit	41B
						3RA2908-1A			
3RA2908-1A									
Blank labels									
	Unit labeling plates¹⁾ for SIRIUS devices	20 mm x 7 mm	Pastel turquoise	3RB2	D	3RT1900-1SB20	100 340 units	41B	
		20 mm x 7 mm	Titanium gray	3RB2	D	3RT2900-1SB20	100 340 units	41B	
3RT1900-1SB20									
3RT2900-1SB20									

1) PC labeling system for individual inscription of unit labeling plates available from:

murrplastik Systemtechnik GmbH
(see Chapter 16, "Appendix" → "External Partners").