

Safe. Reliable. Efficient.

Global LED solutions

for harsh & hazardous areas



EATON

Powering Business Worldwide



Global LED solutions for harsh and hazardous environments

Safe. Reliable. Efficient.

As an industry leader, Eaton's broad range of Crouse-Hinds series LED luminaires are designed for safety, reliability and efficiency in harsh, hazardous and industrial environments.

Why LED?

Energy efficiency

LED average energy consumption is significantly less than traditional fluorescent and HID fixtures

Start/restart time

Instant illumination vs. 10 minute restrike time for HID

Light quality

Higher color rendering compared to fluorescent and HID

Environmental benefits

Mercury-free LED eliminates disposal costs and lowers energy consumption for a smaller carbon footprint

Why Crouse-Hinds series LED?

Industry-best reliability

Built to withstand a wide array of applications

Thermal management

Effective heat sinking ensures longer life

Quality of light

Custom optics designed to maximize light distribution and intensity

Globally certified

Designed to global specifications for NEC and IEC applications, including many local certifications for regional markets





















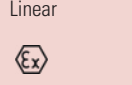

Serviceable drivers

Easy access to drivers for service or replacement

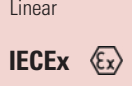
Crouse-Hinds series LED family selection guide

Find out which solution is right for you

Selection guide – Hazardous areas

Area classification	Application	Product	Equivalent light output	Lumen level	Temp Range†	Emergency battery option	DLC Listed*
Class I, Division 2, Class II and/or Zone 2 & Zone 22	Flood 	Champ™ FMVA 	11 models - 70W to 1,500W HID replacement	3,400 - 50,500 lumens	+65°C -40°C		*
	High/mid bay 	Champ™ Intelligent VMVL 	3 models - 70W to 175W HID replacement	3,000 - 7,000 lumens	+65°C -40°C		*
	High/mid bay 	Champ™ VMVL 	9 models - 70W to 1,000W HID replacement	3,000 - 25,000 lumens	+65°C -40°C	✓	*
	Mid/low bay 	NLE 	4 models - 70W to 175W HID replacement	3,000 - 8,000 lumens	+55°C -40°C	✓	*
	Linear 	Pauluhn™ DLLA 	2 models - 2 lamp T5HO replacement	4,000 - 8,000 lumens	+65°C -40°C	✓	*
	Linear 	Champ™ MLLA 	2 models - 2 lamp T5HO replacement	4,000 - 8,000 lumens	+65°C -40°C		
	Linear 	Pauluhn™ Summit 	3 models - up to 6 lamp T5HO replacement	13,000 - 25,000 lumens	+55°C -40°C	✓	
	Linear 	CEAG nLLK15 	3 models - 2 x 18W, 2 x 36W and 2 x 58W fluorescent replacement	2,100 - 9,300 lumens	+50°C -25°C	✓	
	Linear 	nHLL 	3 models - 2 x 18W, 2 x 36W and 2 x 58W fluorescent replacement	3,000 - 8,000 lumens	+55°C -40°C		
	Low bay 	Vaporgard™ V2L/V3L 	2 models - 100W to 200W incandescent & 50W-70W HID	1,700 - 3,300 lumens	+55°C -30°C	✓	
	Emergency and exit 	N2LPS, UX, Ex-Lite, Exit, Exit2  *Zone 1 options available, see product pages.	N/A	Varies by family	Varies by family		
	Wallpack 	Champ™ CPMV 	3 models - 70W to 175W HID replacement	3,400 - 6,800 lumens	+55°C -40°C		



























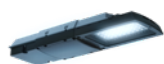









Many of our LED families also have local certifications for specific regional markets (China, Brazil, India, Russia, EAC, etc). Please contact your local Eaton Crouse-Hinds series sales rep or Customer Service center for more information.

† Operating temperature range may vary by lumen models within a product family. Refer to product catalog pages for complete temperature range details.

*For SKUs that are DLC Listed, refer to Eaton's Crouse-Hinds series DLC Listed LED lighting brochure.

Crouse-Hinds series LED family selection guide

Selection guide – Hazardous areas

Area classification	Application	Product	Equivalent light output	Lumen level	Extreme ambients†	Emergency battery option	DLC Listed*
Class I, Division 1 Class II and/or Zone 1 & Zone 21	Floodlight IECEx 	CEAG PXLED 	6 models - 70W to 600W HID replacement	5,000 - 30,000 lumens	+55°C -50°C		
	High/mid bay 	Hazard-Gard™ EVLLA/nEVLLA 	5 models - 100W to 400W HID replacement	6,200 - 13,000 lumens	+65°C -25°C		*
	High/mid bay IECEx 	HPLN 	8 models - 70W to 1,000W HID replacement	3,400 - 24,200 lumens	+55°C -40°C		
	Mid/low bay IECEx 	HPL 	4 models - 70W to 175W HID replacement	3,000 - 8,000 lumens	+50°C -40°C		
	Linear  	Hazard-Gard™ XPLA/ZPLA 	2 models - 2 lamp T5H0 replacement	3,800 - 8,300 lumens	+55°C -25°C		
	Linear IECEx 	CEAG ExLin 	5 models - 2 x 18W, 2 x 36W and 2 x 58W fluorescent replacement	2,900 - 11,200 lumens	+55°C -40°C		
	Linear IECEx 	CEAG eLLK LED 	2 models - 2 x 18W and 2 x 36W fluorescent replacement	2,700 - 5,350 lumens	+55°C -25°C		
	Linear IECEx 	HLL 	2 models - 2 x 18W and 2 x 36W fluorescent replacement	2,800 - 5,700 lumens	+55°C -40°C		
	Linear IECEx 	HRL recessed 	3 models - 2 x 18W, 2 x 36W and 4 x 18W fluorescent replacement	2,950 - 6,000 lumens	+55°C -40°C		
	Linear 	CEAG RLF LED 	3 models - 2 x 1 8W, 2 x 36W and 2 x 54W fluorescent replacement	3373 - 13,447 lumens	+60°C -20°C		
	Linear IECEx 	VLL LED 	3 models - 2 x 18W, 2 x 36W and 2 x 58 W fluorescent replacement	3,100 - 7,400 lumens	+55°C -40°C		
	Low bay 	Hazard-Gard™ EV LED 	2 models - 100W-200W incandescent & 70W-100W HID replacement	1,500 - 2,900 lumens	+55°C -25°C		
Wallpack IECEx 	CEAG AB05 LED 	1 model - 150W incandescent replacement	2,000 lumens	+55°C -55°C			







































Many of our LED families also have local certifications for specific regional markets (China, Brazil, India, Russia, EAC, etc). Please contact your local Eaton Crouse-Hinds series sales rep or Customer Service center for more information.

† Operating temperature range may vary by lumen models within a product family. Refer to product catalog pages for complete temperature range details.

*For SKUs that are DLC Listed, refer to Eaton's Crouse-Hinds series DLC Listed LED lighting brochure.

Find out which solution is right for you

Selection guide – Harsh/heavy & light industrial

Area classification	Application	Product	Equivalent light output	Lumen level	Extreme ambients†	Emergency battery option	DLC Listed*		
Harsh/heavy industrial	Floodlight	 Champ® Pro PFMA  		11 models - 70W to 1,500W HID replacement	3,400 - 50,500 lumens	+65°C -40°C	*		
	High/mid bay	 	Champ Intelligent PVML		3 models - 70W to 175W HID replacement	3,000 - 7,000 lumens	+65°C -40°C	*	
	High/mid bay	 	Champ Pro PVML		9 models - 70W to 1,000W HID replacement	3,000 - 25,000 lumens	+65°C -40°C	✓	*
	Low bay	 	Champ Pro PVMA		2 models - 150W to 175W HID replacement	5,800 - 7,700 lumens	+55°C -40°C		
	Mid/low bay		PLE		4 models - 70W to 175W HID replacement	3,000 - 8,000 lumens	+55°C -40°C	✓	
	Linear		Champ Pro PLLA		2 models - 2 lamp T5HO replacement	4,000 - 8,000 lumens	+65°C -40°C	✓	*
	Linear	 	Pauluhn™ APEX		3 models - up to 6 lamp T5HO replacement	13,000 - 25,000 lumens	+55°C -40°C		
	Linear	 	Pauluhn FPS		2 models - 2 lamp T8 replacement	3,400 - 7,000 lumens	+50°C -20°C	✓	
	Linear		PLLE		4 models - 2 x 18W, 2 x 36W and 2 x 58W fluorescent replacement	3,000 - 8,000 lumens	+55°C -40°C	✓	
	Linear		CEAG LLK 15 LED		3 models - 2x18W, 2x36W and 2x58W fluorescent replacement	1,800 - 8,200 lumens	+55°C -40°C	✓	
Light industrial	Low bay	 	Vaporgard Pro P2L/P3L		2 models - 100W to 200W incandescent; 50W-70W HID	1,700 - 3,300 lumens	+55°C -30°C		
	Wallpack		Champ Pro WPMV		3 models - 70W to 175W HID replacement	3,400 - 6,800 lumens	+55°C -40°C		
	High bay	 	IHB Industrial High Bay		6 models - 250W-1500W HID & 4-10 lamp T5HO replacement	8,450 - 67,000 lumens	+60°C -40°C		
Light industrial	High bay		IHBE high bay		4 models - 400W to 2,000W HID replacement	13,200 - 52,000 lumens	+45°C -30°C		
	Floodlight		PFME floodlight		4 models - 500W to 1500W HID replacement	15,400 - 79,000 lumens	+45°C -30°C		

† Operating temperature range may vary by lumen models within a product family. Refer to product catalog pages for complete temperature range details.

*For SKUs that are DLC Listed, refer to Eaton's Crouse-Hinds series DLC Listed LED lighting brochure.



NEC



CEC



IEC/ATEX

Champ™ FMVA LED floodlights

PRIMARY APPLICATIONS

Indoor and outdoor area lighting in manufacturing plants, heavy industrial chemical and petrochemical facilities, platforms, loading docks and parking lots.

LUMINAIRE MODELS

Model number	Equivalent HID luminaire	Typical energy savings/lifetime
FMVA-3	70W	Up to 78% reduction in energy costs and 150,000 hours of continuous operation!
FMVA-5	100W	
FMVA-7	175W	
FMVA-9	250W	
FMVA-11	320W	
FMVA-13	400W	
FMVA-15	500W	
FMVA20L	600W-750W	
FMVA25L	750W-1000W	
FMVA40L	1,500W+	
FMVA50L	1,500W+	

CERTIFICATIONS & COMPLIANCES

- Class I, Division 2, Groups A, B, C, D
- Class I, Zone 2 (20L-50L only)
- Class II, Division 1, Groups E, F, G
- Type 4X, IP66
- UL844; UL1598; UL1598A; UL8750
- CSA C22.2 No. 137

ELECTRICAL RATINGS

- Voltages: 100-277 VAC/125-250 VDC, 347-480 VAC
- Input power: 31W, 45W, 59W, 58W, 75W, 90W, 105W, 177W, 217W, 340W, 400W

OPTIONS AND ACCESSORIES

- Bolt-on visor; bolt-on wire guard (not available on 9L-15L)
- Floodlight slipfitter (not available for 40L & 50L)
- Slipfitter wall mount adapter (not available for 40L & 50L)
- Diffused glass or polycarbonate lens (not available on 20L-50L)
- Bull horn
- 6x6 (3-7L models), 7x6 & 3x3 (9-50L models)

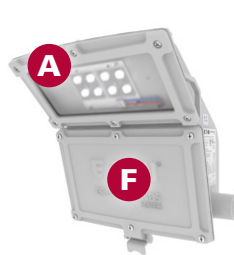

FMVA-3 - 7

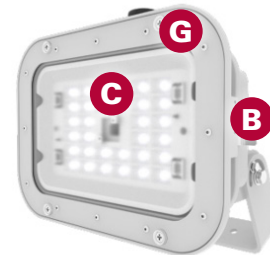

FMVA-9 - 15



FMVA40L - 50L



FMVA20L - 25L

Up to 6 times longer life and up to 78% reduction in power consumption compared to equivalent HID floodlights

DESIGN FEATURES

- A Versatile design** - Can be used for outdoor or indoor applications, and for a wide range of mounting heights depending on model and light level requirement.
- B Rugged heat sink** - Designed to perform in high ambient temperatures up to +65°C and as low as -40°C. The thick walls of the castings make for a tough, rugged housing that keeps the internal driver and LED temperatures down.
- C High lumen output** - Up to 162 lumens per watt.
- D Full-frame yoke** - Designed to utilize the SFA6 slipfitter and SWB6 wall mount bracket, making it ideal for retrofit or new installations (not available for 40L & 50L).
- E Multiple lens options** - Tempered and clear glass standard, polycarbonate and diffused glass options available.
- F Smaller and lighter** - FMVA-3 through FMVA-7 units are 20lbs lighter than previous models (3L-25L model). FMVA-9 through FMVA-15 units are 10lbs lighter than previous models (3L-25L model).
- G Serviceable** - Driver and LED engine are field replaceable for extended life even beyond the warranty (FMVA-9 through FMVA-15 only).

† Operating temperature range may vary by lumen models within a product family. Refer to product catalog pages for complete temperature range details.

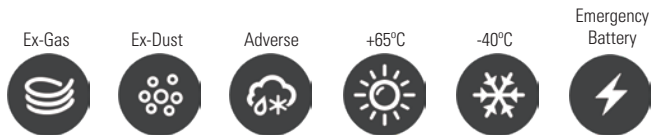

Available with an integral battery back-up for emergency lighting applications!

VMVL-17 – VMVL-25

Custom Type I, III and V optics for better output, zero maintenance and reduced energy consumption

DESIGN FEATURES

- A Modular design** - This contractor-friendly design is ideal for both retrofit and new construction applications.
- B Integrated antenna** - Enables effortless connection to our Brightlayer Industrial lighting control interface. No complex hardware required to commission and control the lights. Bluetooth Low Energy (BLE) protocol enables decentralized control of the system without complex and expensive IT network infrastructure - up to 100-foot range fixture-to-fixture.
- C Intelligent multi-sensor** - Replaceable sensor can be factory installed or field installed at a later date (sensor is integral to light fixture - no field wiring required). PIR occupancy sensor to automatically illuminate areas once presence is detected and photo sensing for daylight harvesting and lux reporting.
- D Type 4X Rated** - The LED housing is constructed of durable die cast aluminum, providing an efficient thermal path to the heat sink assembly. The impact-resistant lens is sealed from the outside environment and provides ingress protection against water and dust.
- E Safe, reliable heat transfer** - Die cast aluminum housing provides safe and effective heat transfer from the LED assembly to the outside environment, ensuring low LED junction temperature, reliability and sustained lumen performance.
- F Custom optics and colors** - Directs light where you need it, helping eliminate gaps and dark spots which can potentially reduce the number of light fixtures required in specific applications. Green and amber LEDs available for wildlife conservation applications.

† Operating temperature range may vary by lumen models within a product family. Refer to product catalog pages for complete temperature range details.

Champ VMVL LED luminaires

PRIMARY APPLICATIONS

Locations requiring continuous and consistent light levels in extreme ambient temperatures, such as manufacturing plants, heavy industrial or petrochemical facilities, food and beverage facilities, platforms, loading docks, tunnels, outdoor wall and stanchion mounted general area lighting.

LUMINAIRE MODELS

Model number	Equivalent HID luminaire	Typical energy savings/lifetime
VMVL-3	70W	Up to 77% reduction in energy costs and 60,000 hours of continuous operation!
VMVL-5	100W	
VMVL-7	175W	
VMVL-9	250W	
VMVL-11	320W	
VMVL-13	400W	
VMVL-17	400W-600W	
VMVL-21	600W-750W	
VMVL-25	750W-1,000W	

CERTIFICATIONS & COMPLIANCES

- Class I, Division 2, Groups A, B, C, D
- Class I, Zone 2 nA; Zone 21 tb
- Class II, Division 1, Groups E, F, G; Class III
- Simultaneous presence
- UL844; UL1598; UL1598A; UL8750; UL50; UL50E
- cUL Listed to CSA C22.2 No. 137
- NEMA Type 4X, IP66, Wet Locations
- IECEX/ATEX Certified; Zone 2/21
- CE

ELECTRICAL RATINGS

- Voltages: 100-277 VAC/127-250 VDC, 347-480 VAC
- Input power: 28W, 45W, 61W, 76W, 92W, 95W, 133W, 165W, 199W

OPTIONS AND ACCESSORIES

- Integral back-up battery (90 minutes of emergency lighting, VMVL-3 to VMVL-11 only)
- Quick Clip to simplify installation
- Diffused lens, Teflon coated lens, polycarbonate lens and upright refractor lens
- Wire guard
- Trunnion mount
- Cone top hat
- Type I, III and V optics (VMVL-3 to VMVL-13 only)
- 6-pole terminal block

NLE LED light fixtures

PRIMARY APPLICATIONS

Certified for Zone 2 and Zone 21 hazardous areas. Suitable for mid bay and low bay lighting applications in chemical, petrochemical, pharmaceutical, platforms, shipyards, loading docks, wastewater treatment and paper mills.

LUMINAIRE MODELS

Model number	Equivalent HID luminaire	Typical energy savings/lifetime
NLE 3L	70W-100W	Up to 66% reduction in energy costs
NLE 5L	100W-150W	
NLE 7L	150W-175W	
NLE 8L	150W-175W	

CERTIFICATIONS & COMPLIANCES

- Ex nR IIC T5/T6 Gc
- Ex tb IIIC T80/T100 Db
- IECEx Certification of Conformity : IECEx CQM 16.0013X
- EC-Type Examination Certificate : EPT 16 ATEX 2452X
- IP66

ELECTRICAL RATINGS

- Voltages: 100-240 VAC; 108-250 VDC
- Input power: 30W, 50W, 70W, 80W

OPTIONS AND ACCESSORIES

- Clear or diffused glass lens
- Warm white (3000K) and cool white (5700K) color temperatures

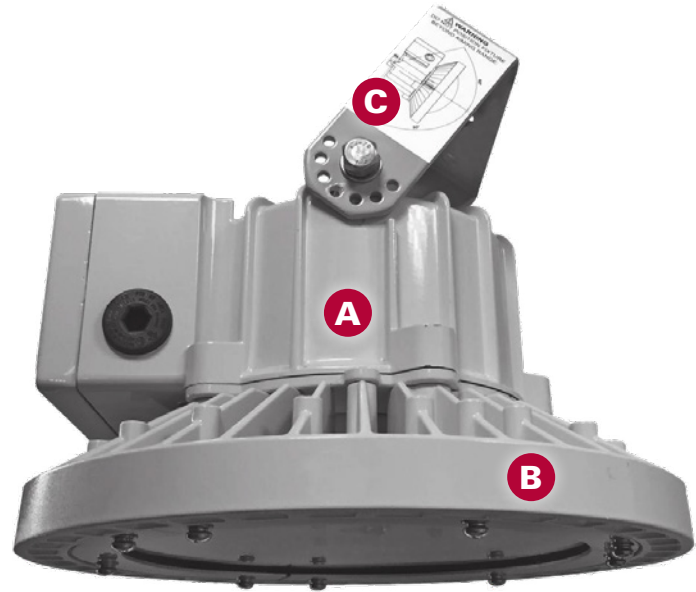

Low profile and lightweight design, easy to install and reliable illumination in Zone 2 and 21 areas

DESIGN FEATURES

- A Rugged design** - Highly durable aluminum housing with a tempered and impact-resistant glass globe. NLE fixture has an operating temperature range of -40°C to +55°C.
- B Lightweight and compact** - Low profile and lightweight design is ideal for compact installations.
- C Ease of installation** - U-shaped yoke mount provides mounting flexibility - wall, ceiling, pole, etc.

† Operating temperature range may vary by lumen models within a product family. Refer to product catalog pages for complete temperature range details.



Ex-Gas



Ex-Dust



Adverse



+65°C



-40°C



Emergency Battery

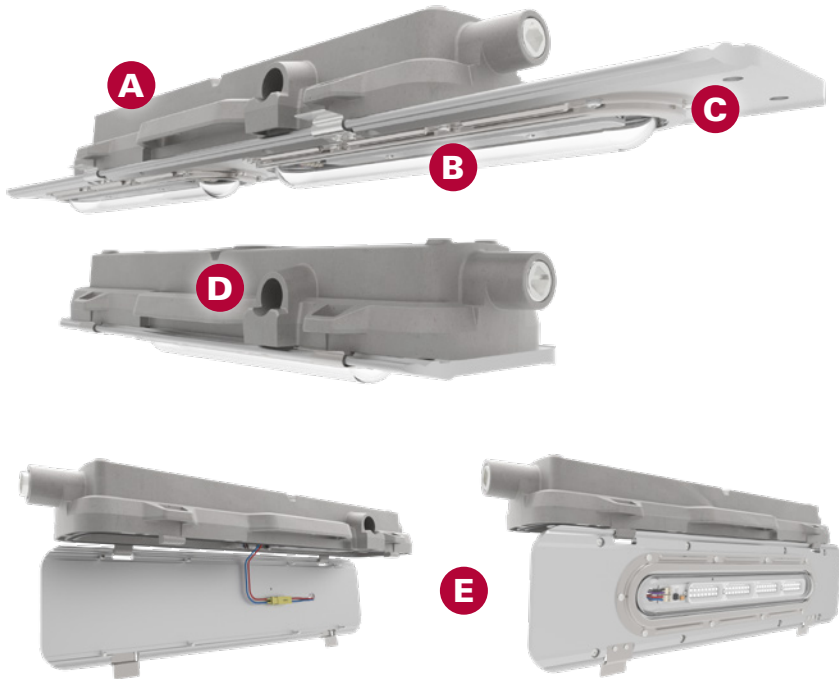

Up to 67% more energy efficient than a T5HO fluorescent light and 8 times the rated life

DESIGN FEATURES

- A Best-in-class efficacy** - Up to 134 lumens per watt (*MLLA2 with UNV34 driver*).
- B Custom optics** - Standard wide beam spread for maximum illumination on wall panels. Full cut-off beam spread option for targeted illumination; avoids spillage and light loss.
- C Built to last** - Passed 2,000 psi high pressure hose test; passed 5G vibration test; 60,000 hour lifetime at 55°C ambient.
- D Slim profile** - 4.4" fixture height (excluding mounting brackets), perfect for mounting in confined or low height areas.
- E Serviceable driver and light engine** - easy access to drivers for wiring and field replaceable light engines available.

† Operating temperature range may vary by lumen models within a product family. Refer to product catalog pages for complete temperature range details.

Champ™ MLLA linear LED light fixtures

PRIMARY APPLICATIONS

Oil and gas refineries, petrochemical facilities, food and beverage facilities, platforms, loading docks, tunnels, outdoor and stanchion mounted general area lighting, and where flammable vapors, gases, ignitable dusts, fibers or flyings are present.

LUMINAIRE MODELS

Model number	Equivalent fluorescent luminaire	Typical energy savings/lifetime
MLLA2	2 x 2 ft. T5/T8/T12HO	Up to 67% reduction in energy costs and 60,000 hours of continuous operation!
MLLA4	2 x 4 ft. T5/T8/T12HO	Up to 67% reduction in energy costs and 60,000 hours of continuous operation!

CERTIFICATIONS & COMPLIANCES

- Class I, Division 2, Groups A, B, C, D
- Class I, Zone 2
- Class II, Division 1, Groups E, F, G
- Class III
- UL844; UL1598; UL1598A; UL8750
- CSA C22.2 Nos. 137, 141, 250
- Type 4X, IP66/67, Marine and Wet Locations

ELECTRICAL RATINGS

- Voltages: 120-277 VAC/127-250 VDC, 347-480 VAC
- Input power: 31W, 54W

OPTIONS AND ACCESSORIES

- Available with a self-contained battery system for emergency lighting applications
- Diffused glass or polycarbonate lens
- Offset ceiling, offset ceiling swivel, flush, pendant and pole mount options available
- Safety chain kit
- Epoxy painted or natural aluminum finish



Pauluhn™ DLLA linear LED light fixtures

PRIMARY APPLICATIONS

Designed to replace fluorescent T12, T8 and T5HO lighting on land based and offshore drilling platforms, the Pauluhn DLLA is the ideal solution for high vibration, impact and hose down in drilling applications

LUMINAIRE MODELS

Model number	Equivalent fluorescent luminaire	Typical energy savings/lifetime
DLLA2	2 x 2 ft. T5/T8/T12HO	Up to 67% reduction in energy costs and 60,000 hours of continuous operation!
DLLA4	2 x 4 ft. T5/T8/T12HO	

CERTIFICATIONS & COMPLIANCES

- Class I, Division 2, Groups A, B, C, D
- Class I, Zone 2
- Class II, Division 2, Groups F, G
- Class III
- UL844; UL1598; UL1598A; UL8750
- CSA C22.2 No. 137 and 250
- Type 4X, IP66/67, Marine and Wet Locations

ELECTRICAL RATINGS

- Voltages: 120-277 VAC, 347-480 VAC, 127-250 VDC
- Input power: 31W, 54W

OPTIONS AND ACCESSORIES

- Available with a self-contained battery system for emergency lighting applications
- Diffused glass or polycarbonate lens
- Offset ceiling, offset ceiling swivel, flush, pendant and pole mount options available
- Safety chain kit
- Epoxy painted or natural aluminum finish

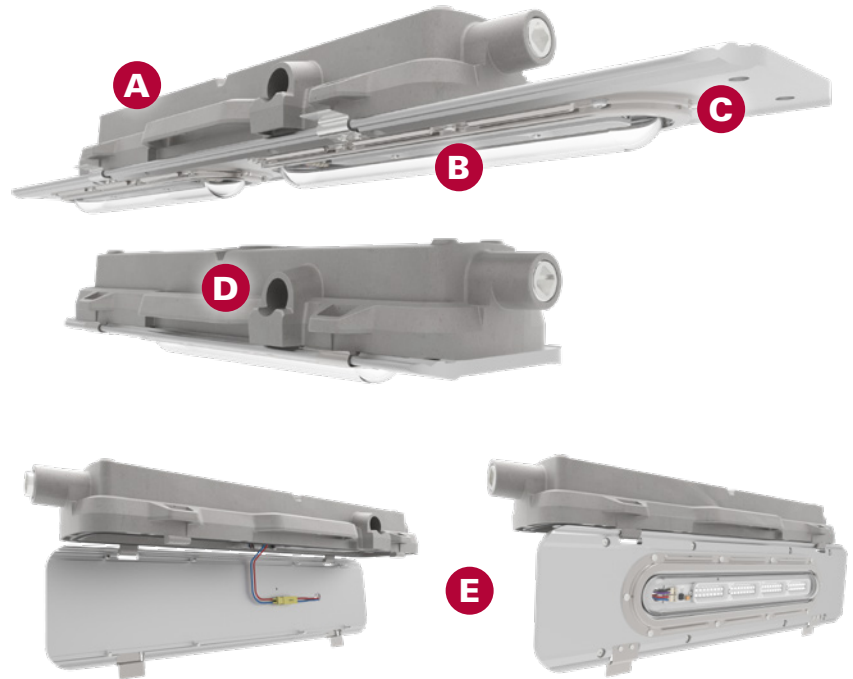
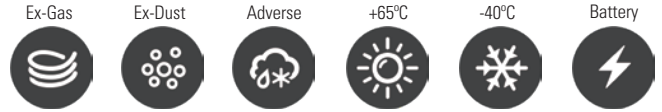

Up to 67% more energy efficient than a T5HO fluorescent light and 8 times the rated life

DESIGN FEATURES

- A Best-in-class efficacy** - Up to 134 lumens per watt. (MLLA2 with UNV34 driver)
- B Custom optics** - Standard wide beam spread for maximum illumination on wall panels. Full cut-off beam spread option for targeted illumination; avoids spillage and light loss.
- C Built to last** - Passed 2,000 psi high pressure hose test; passed 5G vibration test; 60,000 hour lifetime @ 55°C ambient.
- D Slim profile** - 4.4" fixture height (excluding mounting brackets), perfect for mounting in confined or low height areas.
- E Serviceable driver and light engine** - easy access to drivers for wiring and field replaceable light engines available.

† Operating temperature range may vary by lumen models within a product family. Refer to product catalog pages for complete temperature range details.



Ex-Gas



Ex-Dust



Adverse



+55°C



-40°C

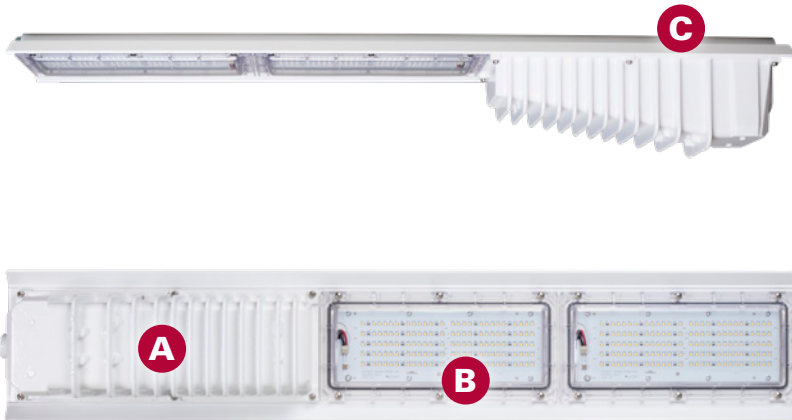

NSF Splash Zone rated, 1500 psi hose down tested and an angled housing to mitigate debris build-up

DESIGN FEATURES

- A Innovative and robust design** - Angled light fixture mitigates debris build-up. Withstands 1500 psi high pressure wash down, and food rated paint maintains safety.
- B High performance optics and drivers** - 100+ lumens per watt provides highly efficient lighting. Rated life is up to 60,000 hours of maintenance-free and safe operation.
- C Easily customized for application-specific performance** - Versatile mounting options with a through feed design for simplified multiple fixture wiring.

† Operating temperature range may vary by lumen models within a product family. Refer to product catalog pages for complete temperature range details.

Pauluhn™ Summit LED linear light fixtures

PRIMARY APPLICATIONS

Replaces fluorescent T12, T8, and T5HO fixtures in hazardous rated food processing, hose down and corrosive environments.

The Summit LED was designed with food and beverage processing facilities in mind. The fixture housing is angled to mitigate debris build-up and features a food-rated epoxy powder coat finish. Plus, its robust design can withstand 1,500 psi hose pressure for wash down applications.

LUMINAIRE MODELS

Model number	Equivalent luminaire	Typical energy savings/lifetime
SUM13L	3 lamp T5HO	Up to 50% reduction in energy costs and minimum 60,000 hours of continuous operation!
SUM17L	4 lamp T5HO	
SUM25L	6 lamp T5HO	

CERTIFICATIONS & COMPLIANCES

- Class I, Division 2, Groups A, B, C, D
- Class II, Division 1, Groups F, G
- UL1598; UL8750, UL844
- CSA 22.2 No. 137
- NSF Splash Zone
- Type 4X; IP66

ELECTRICAL RATINGS

- Voltages: 120-277 VAC/127-250 VDC, 347-480 VAC
- Input power: 122W, 144W, 217W

OPTIONS AND ACCESSORIES

- Clear or diffused polycarbonate lens
- 0-10V dimming capabilities
- Surface/swivel mount, cable/chain mount and threaded rod mount



CEAG™ nLLK15 LED linear light fixtures

PRIMARY APPLICATIONS

Long-life LED tubes provide general illumination, indoors or out, in Zone 2 and 22 hazardous environments around the globe. Heavy duty, non-metallic construction stands up to tough physical and environmental demands, making it an excellent choice where dust, dirt, gas, vapor, smoke, fumes, moisture, corrosive and wet conditions are present.

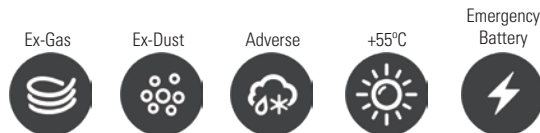

LUMINAIRE MODELS

Model number	Equivalent fluorescent luminaire	Typical energy savings/lifetime
nLLK15 LED 600	2 x 18W	Up to 77% more efficient than standard LED light fixtures!
nLLK15 LED 1200	2 x 36W	
nLLK15 LED 1500	2 x 58W	

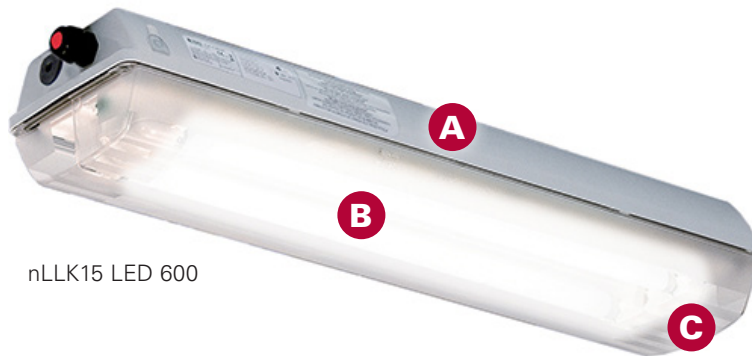

nLLK15 LED 600



nLLK15 LED 1200 and 1500

CERTIFICATIONS & COMPLIANCES

Marking accd. to 2014/34/EU:

- Ex II 3 G Ex ec IIC T4 Gc
- Ex II 3 D Ex tc IIIC T80°C Dc
- EC-Declaration of Conformity: CCH 15 ATEX 1044
- IP66

ELECTRICAL RATINGS

- Voltage: 220-240 VAC/DC
- Input power: 18W, 37W, 49W

OPTIONS AND ACCESSORIES

- Available with safety switch on request
- Self-contained battery version available
- Connection to CEAG emergency light monitoring systems possible (V-CG-S)
- Light controlling via DALI interface (DALI option)

Crisp, bright light and durability in harsh environments provides a long-life solution in Zone 2 and 22 areas

DESIGN FEATURES

- A Built to last** - Heavy duty, non-metallic construction stands up to tough physical and environmental demands, making it an excellent choice where dust, dirt, gas, vapor, smoke, fumes, moisture, corrosive and wet conditions are present.
- B High output** - Utilizes Aura UltiLED LED tubes for extreme applications, providing high efficacy and long life.
- C Emergency** - Available with a self-contained battery system or V-CG-S module for monitoring with an Eaton central battery system.

† Operating temperature range may vary by lumen models within a product family. Refer to product catalog pages for complete temperature range details.



IECEX

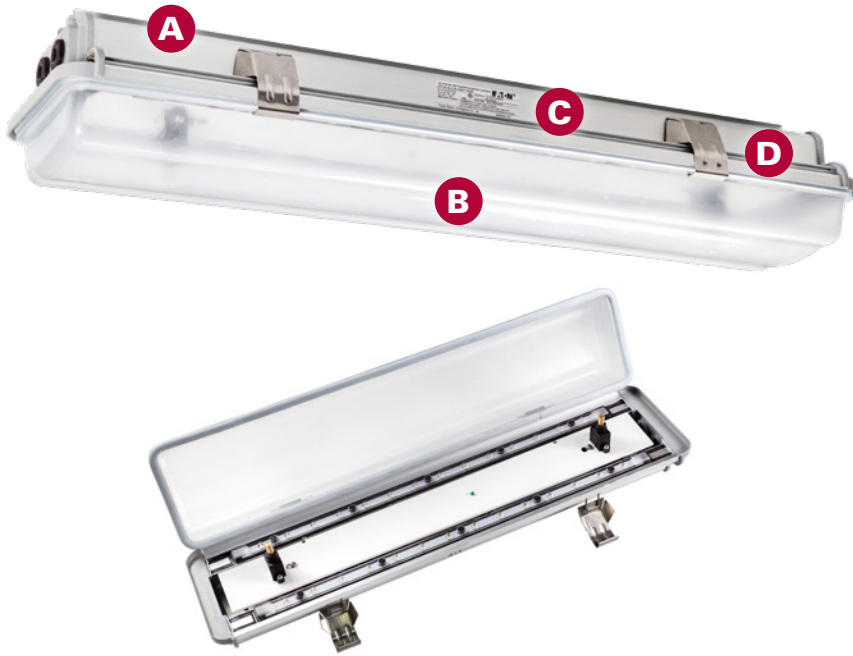
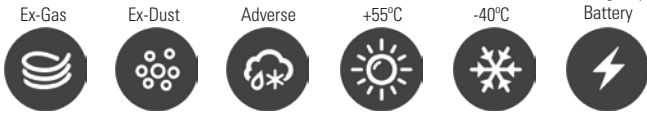

Rugged, low profile fixture that is easy to install and provides clear illumination in Zone 2 and 22 hazardous areas

DESIGN FEATURES

- A Rugged design** - Copper-free aluminum housing and impact-resistant polycarbonate lens provide excellent resistance to corrosion and heat.
- B Easy installation** - Lightweight design, hinged cover, and a terminal block wing for easy installation and maintenance.
- C Industry-leading thermal management** - For safe and reliable operation over a wide temperature range.
- D Retrofit friendly** - Fixture utilizes the same mounting footprint of linear fluorescent lighting.

† Operating temperature range may vary by lumen models within a product family. Refer to product catalog pages for complete temperature range details.

nHLL LED linear light fixtures

PRIMARY APPLICATIONS

Constructed with an aluminum housing and high impact-resistant polycarbonate cover for use in Zone 2 and 22 hazardous areas where moisture or corrosion may be a problem, such as offshore oil platforms, pharmaceutical and chemical plants, oil refineries and industrial locations.

LUMINAIRE MODELS

Model number	Equivalent luminaire	Typical energy savings/lifetime
NHLL-2-C2-3L	2 x 18W	Up to 39% reduction in energy costs and 50,000 hours of continuous operation!
NHLL-2-C2-4L	2 x 36W	
NHLL-4-C2-5L	2 x 36W	
NHLL-4-C2-8L	2 x 58W	

CERTIFICATIONS & COMPLIANCES

- Ex db ec IIC T5/T6 Gc
- Ex ec IIC T5/T6 Gc
- Ex db ec ib mb IIC T5/T6 Gc
- Ex ec ib mb IIC T5/T6 Gc
- Ex tb IIIC T80°C Db
- IECEx certification of conformity: IECEx NEP 18.0003X
- EC-Type examination certificate: SEV 18 ATEX 0171X
- IP66

ELECTRICAL RATINGS

- Voltage: 100-240 VAC, 108-250 VDC
- Input power: 30W, 40W, 60W, 80W

OPTIONS AND ACCESSORIES

- Epoxy coating on aluminum housing
- Emergency battery back-up
- Pipe, wall, and ceiling mounts available
- Available with safety switch on request



Vaporgard™ V2L/V3L LED luminaires

PRIMARY APPLICATIONS

Indoor or outdoor areas with low mounting heights or confined spaces, such as tunnels and catwalks, over doorways or entries, landing areas, utility rooms, etc.

LUMINAIRE MODEL

Model number	Equivalent luminaire	Typical energy savings/lifetime
V2LM2	50W HID or 150-200W incandescent	Up to 90% reduction in energy costs and 50,000 hours of continuous operation!
V3LM2		

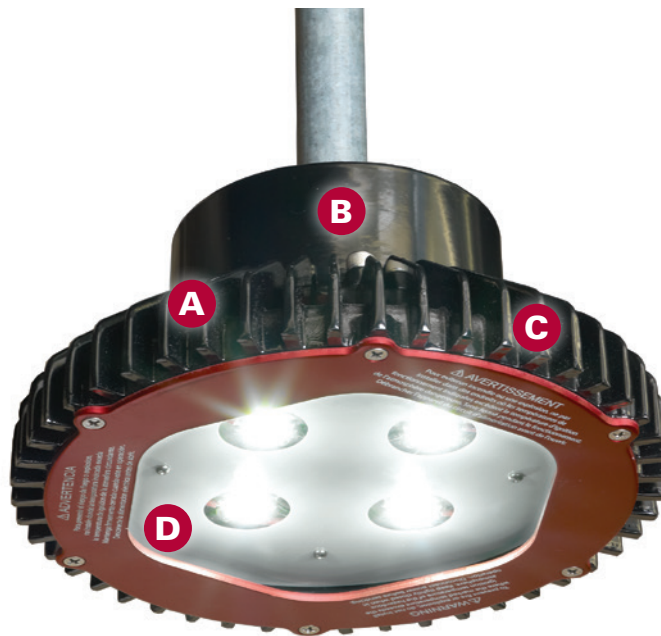

CERTIFICATIONS & COMPLIANCES

- Class I, Division 2, Groups A, B, C, D
- Class II, Division 1, Groups F, G
- UL844; UL1598; UL1598A
- CSA C22.2 No. 137
- NEMA 4X
- IP66
- RoHS Compliant
- ATEX/IECEx Zone 2/22

ELECTRICAL RATINGS

- Voltages: 120-277 VAC, 10-30 VDC
- Input power: 14W, 29W

OPTIONS AND ACCESSORIES

- Clear or diffused glass lens, Teflon coated lens
- Color temperatures: warm white (3000K), cool white (5000K)
- 10-30 VDC driver

90% more energy-efficient than a 200 watt incandescent and over 20 times the rated life

DESIGN FEATURES

- A Domeless reflector, low profile design** - Designed for low mounting heights and confined spaces where incandescent and HID based luminaires are too large.
- B Installation and replacement made simple** - Installed using the same mounting modules as existing Crouse-Hinds series Vaporgard™ fixtures.
- C Safe, reliable heat transfer** - Heat sink engineered to safely and effectively remove heat from the LED and driver, ensuring long product life and superior T-ratings.
- D High power multi-die LED arrays** - Provides instant on and full illumination in the harshest conditions, even when exposed to high, repeated vibration.

† Operating temperature range may vary by lumen models within a product family. Refer to product catalog pages for complete temperature range details.

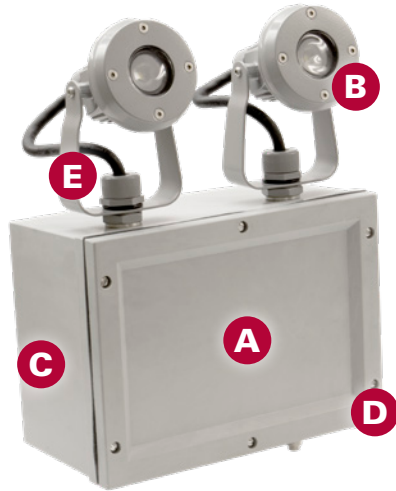

Our N2LPS M2 is smaller, lighter and more energy efficient than the previous model!

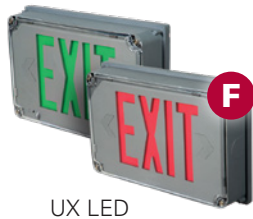

UX LED



EX-LITE

*Not for use with N2LPS luminaire.



EXIT / EXIT 2

*Not for use with N2LPS luminaire.

LED egress, emergency and exit lighting designed for harsh and hazardous locations

N2LPS M2 DESIGN FEATURES

- A Non-metallic, enclosed, gasketed housing** - Provides corrosion protection in the most extreme environments.
- B Durable and marine rated LED lamp head assemblies** - Provide protection against water ingress, corrosion and impact.
- C Nickel cadmium battery** - High temperature rated nickel cadmium battery for reliable operation up to 55°C ambient.
- D Reduced maintenance costs** - Self-test, monitoring and diagnostics reduce costly maintenance checks.
- E Remote mountable lamp heads** - Lamp heads can be mounted independently from the enclosure, allowing you to focus light where you need it.

Exit Lighting DESIGN FEATURES

- F Corrosion- and impact-resistant housing** - Ensures long product life and reliability.
- G Nickel cadmium battery** - Premium heavy duty nickel cadmium battery with 24-hour charge and recharge time increases safety by recovering quickly from an outage.
- H Multiple "EXIT" legend options** - EXIT inscriptions, pictograms, and directional arrows to meet customer preferences.

* Zone ratings vary by product family. Refer to individual catalog pages for complete certifications and compliances.

† Operating temperature range may vary by lumen models within a product family. Refer to product catalog pages for complete temperature range details.

LED emergency and exit lights

N2LPS M2 emergency lighting PRIMARY APPLICATIONS

Used to provide reliable illumination for egress areas during failure or interruption of power to the normal lighting system.

LUMINAIRE MODEL

Model number	Battery life
N2LPSM2	90 minutes

CERTIFICATIONS & COMPLIANCES

- Class I, Division 2, Groups B, C, D
- Class I, Zone 2
- UL844; UL924; UL1598A
- CSA C22.2 No. 141-M1985; C22.2 No. 137-M1981
- Life Safety Code NFPA101® - Section 5-9
- NEMA 4X, Marine and Wet Locations

ELECTRICAL RATINGS

- Power supply input: 120-277 VAC; 6W max.
- LED heads: 12 VDC, 1W LED, 6W max.

LED Exit Signs

PRIMARY APPLICATIONS

Used for marking escape routes and exits in potentially explosive atmospheres.

LUMINAIRE MODELS

Model Number	Rating	Battery
Ex-Lite	Hazardous	Optional
UX LED	Industrial or hazardous	Optional
EXIT / EXIT 2	Hazardous	Optional

CERTIFICATIONS & COMPLIANCES

UX LED: (Certified for use with N2LPS luminaire)

- Class I, Division 2, Groups A, B, C, D
- NEMA 4X, IP66, Outdoor Wet Locations
- UL50; UL844; UL924; UL1598A

Ex-Lite: (Not for use with N2LPS luminaire)

- Class I, Division 2, Groups A, B, C, D
- Class I, Zone 1
- Class II, Division 2, Groups F, G (NEC)
- IP66
- UL844; UL924; UL60079; UL1203

EXIT / EXIT 2: (Not for use with N2LPS luminaire)

- Ex e ib mb IIC T6/T5 Gb; Ex tb IIIC T80°C Db
- IECEx BVS 13.0017
- EC-Type Examination Certificate: BVS 09 ATEX E 029

ELECTRICAL RATINGS

- Please refer to individual catalog pages

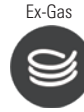

Champ™ CPMV LED wallpack light fixtures

PRIMARY APPLICATIONS

Provides a low profile solution for hazardous lighting applications. It's the ideal choice for vertical surface lighting where harsh and hazardous conditions require high quality, reliable illumination.

LUMINAIRE MODELS

Model number	Equivalent HID luminaire	Typical energy savings/lifetime
CPMV3L	70W	Up to 70% reduction in energy costs and 60,000 hours of continuous operation!
CPMV5L	100W	
CPMV7L	150W-175W	

CERTIFICATIONS & COMPLIANCES

- Class I, Division 2, Groups A, B, C, D
- Class II, Division 1, Groups E, F, G
- UL844; UL1598; UL1598A; UL8750
- CSA C22.2 No. 137
- NEMA 4X, IP66, Marine and Wet Locations

ELECTRICAL RATINGS

- Voltages: 120-277 VAC/125/250 VDC, 347-480 VAC
- Input power: 30W, 45W, 59W

OPTIONS AND ACCESSORIES

- Available with a variety of lens types, including clear glass, diffused glass, clear polycarbonate and diffused polycarbonate
- Yoke mount and hub mount options are available
- Available with a photocell

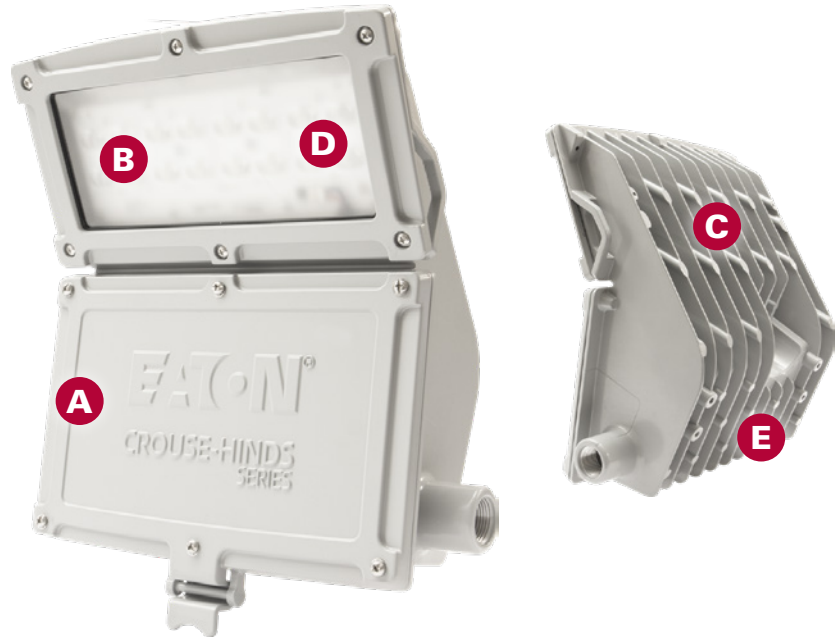

Low profile, long life and high performance in Class I, Division 2 and Class II, Division 1 areas.

DESIGN FEATURES

- A Built to last** - Rated for 60,000+ hours of operation at 55°C. Impact-resistant lens sealed from the outside environment provides ingress protection against water and dust. Easily removeable cover allows for field serviceable driver maintenance.
- B High efficiency** - Up to 116 lumens per watt.
- C Rugged design** - Engineered to perform in ambient temperatures from -40°C to +55°C. Die cast aluminum LED housing provides efficient thermal path to heat sink assembly, and vertical fin design facilitates air flow and dust shedding.
- D Multiple optic and lens options** - Available with a variety of lens types, including clear glass, diffused glass, clear polycarbonate and diffused polycarbonate.
- E Simple installation** - Contractor-friendly design is ideal for both retrofit and new construction. Available with lever lock connectors.

† Operating temperature range may vary by lumen models within a product family. Refer to product catalog pages for complete temperature range details.



Champ LED Intelligent Lighting

for harsh and hazardous areas



Lower total cost of ownership

Real-time insights into fixture health plus smart features that help reduce energy usage and extend fixture lifespan up to 2x.



Improve safety and performance

Performance monitoring for safer environments and proactive maintenance to help reduce downtime.



Easy to install and maintain

Streamline initial setup and minimize the need for disruptive replacements with extended fixture life.



Powered by Brightlayer Industrial

Control your lights from an intuitive app-based interface with no special hardware, gateways, or servers required.

LED vs. conventional lighting technologies

Why are so many facilities making the switch to Crouse-Hinds series LED?

The numbers say it all.

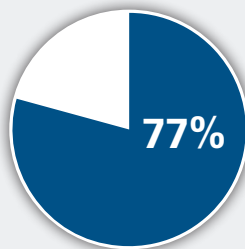

AVERAGE REDUCTION IN ENERGY COSTS



MAINTENANCE REDUCTION

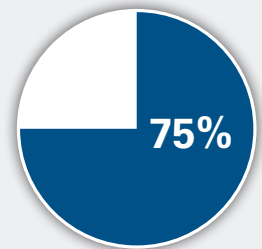

75% LOWER TOTAL COST OF OWNERSHIP

Assumptions: Calculations based on overall life of the LED system. Energy cost of \$.09 per kilowatt; 24 hour per day operation; labor rate of \$75 each for 2 workers; average time for fixture maintenance of 1 hour.

CEAG™ PX LED floodlights

PRIMARY APPLICATIONS

Ideal for ceiling and wall mounted general area lighting where flammable vapors and gases are present, along with harsh conditions including vibration, dust, moisture, corrosive atmospheres and extreme temperatures.

LUMINAIRE MODELS

Model number	Equivalent HID luminaire	Typical energy savings/lifetime
PXLED5L	100W-150W	Up to 70% reduction in energy costs and 60,000 hours of continuous operation!
PXLED10L	175W-250W	
PXLED15L	400W-500W	
PXLED20L	600W-750W	
PXLED25L	750W-1,000W	
PXLED30L	1,500W	

CERTIFICATIONS & COMPLIANCES

Marking accd. to IECEx:

- Ex db eb op is q IIC T4 Gb
- Ex tb op is IIIC T100°C Db

Marking accd. to 2014/34/EU:

- Ex II 2 G Ex db eb op is q IIC T4 Gb
- Ex II 2 D Ex tb op is IIIC T100°C Db
- BVS 17 ATEX E 013 X
- IECEx Certificate of Conformity: IECEx BVS 17.0004 X
- IP66/67

ELECTRICAL RATINGS

- Voltages: 110-277 VAC, 127-270 VDC
24-48 VDC available for PXLED 5L
- Input power: 49W, 98W, 147W, 196W, 245W, 294W

OPTIONS AND ACCESSORIES

- Wide, narrow and asymmetric beam options
- Pole mounting



60,000 hour rated life at 55°C helps ensure years of reliable performance in hazardous IEC applications

DESIGN FEATURES

- A Modular design** - Provides six models with light output ranging from 5,000 lumens up to 32,000 lumens.
- B High efficiency LEDs** - Delivers up to 110 lm/W, reducing energy costs by up to 70% over conventional lamps.
- C Easy installation and maintenance** - Ex-e compartment provides quick access to the driver and terminals.
- D Simple, flexible alignment** - Stainless steel swivel bracket with adjustable setting angle allows an easy alignment of the floodlight.
- E Custom optics** - Wide and narrow beam pattern options distribute light where you need it most.
- F Built to last** - Designed for offshore and high vibration applications. Operating temperature -50 °C up to +55 °C.

† Operating temperature range may vary by lumen models within a product family. Refer to product catalog pages for complete temperature range details.

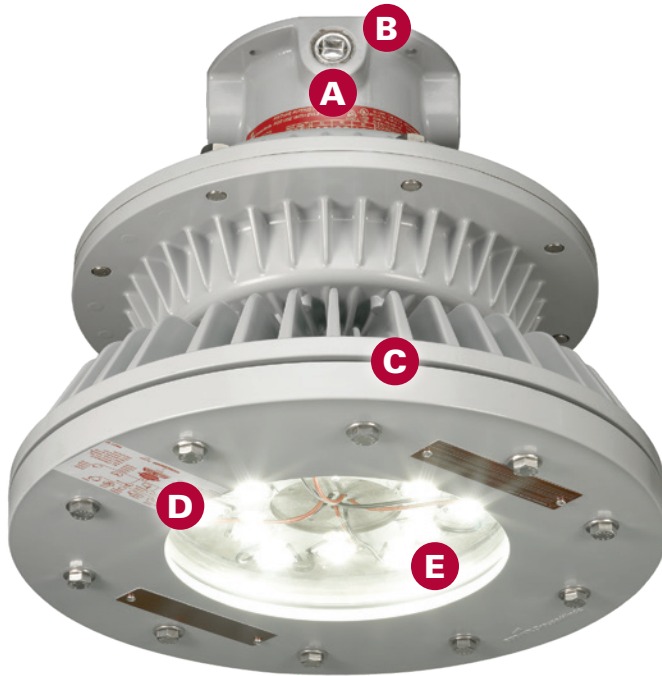

Energy-efficient and globally certified explosionproof workhorse for general area and high bay lighting applications

DESIGN FEATURES

- A Retrofittable to install base** - Adapter available for connection to existing Hazard-Gard® EVI, EVLP and EVM modules.
- B Quick-connect design** - Install and wire the mounting module, then simply screw in the luminaire.
- C Factory sealed** - No external sealing fittings required in Groups B, C and D.
- D 60,000 hours rated life** - Eliminates the need for frequent lamp replacement.
- E Shock- and vibration-resistant** - The LED housing is constructed of durable die cast aluminum, providing efficient long life.

† Operating temperature range may vary by lumen models within a product family. Refer to product catalog pages for complete temperature range details.

Hazard-Gard™ EVLLA LED luminaires

PRIMARY APPLICATIONS

Used for general lighting in areas where flammable or explosive vapors or gases are present, such as petroleum refineries, chemical and petrochemical plants, oil terminals, gas plants, drilling platforms and wastewater treatment plants.

LUMINAIRE MODELS

Model number	Equivalent HID luminaire	Typical energy savings/lifetime
EVLLA5L	100W-150W	Up to 62% reduction in energy costs and 60,000 hours of continuous operation!
EVLLA7L	150W-175W	
EVLLA9L	175W-250W	
EVLLA11L	250W-320W	
EVLLA13L	320W-400W	

CERTIFICATIONS & COMPLIANCES

- Class I, Division 1, Groups B, C, D
- Class II, Groups E, F, G
- Class III, Simultaneous Presence
- UL844; UL1598; UL1598A
- CSA C22.2 No. 137
- NEMA 4X, IP66, Wet Locations

ELECTRICAL RATINGS

- Voltages: 120-277 VAC/108-250 VDC, 347-480 VAC
- Input power: 59W, 69W, 81W, 115W, 130W

OPTIONS AND ACCESSORIES

- Trunnion mount
- Guard
- Color temperature: warm (3000K), cool (5000K) or neutral (4000K)
- Pendant, ceiling, stanchion and wall mounts
- Epoxy painted

HPLN LED Luminaires

PRIMARY APPLICATIONS

Suitable for Zone 1 and Zone 2 Ex-Gas and Zone 21/22 Ex-Dust hazardous areas, such as heavy industrial, chemical, petrochemical or pharmaceutical facilities, platforms, shipyards, electric power, loading docks, wastewater treatment plants and paper mills.

LUMINAIRE MODELS

Model number	Equivalent HID luminaire	Typical energy savings/ lifetime
HPLN-3L	70W-100W	Up to 60% reduction in energy costs
HPLN-5L	100W-150W	
HPLN-7L	150W-175W	
HPLN-9L	175W-250W	
HPLN-11L	250W-450W	
HPLN-15L	400W	
HPLN-21L	600W	
HPLN-25L	600W-1,000W	

CERTIFICATIONS & COMPLIANCES

Marking accd. to IECEx:

- Ex db eb mb op is IIC T4 Gb
- Ex tb op is IIIC T95°C Db

Marking accd. to 2014/34/EU:

- II 2 G Ex db eb mb op is IIC T4 Gb
- II 2 D Ex tb op is IIIC T95°C Db

Certificate No.

- IECEx PRE 19.0058X
- Presafe 19 ATEX 09286X

Permissible ambient temperature

- -40°C up to +55°C

Degree of protection accd. to EN60529

- IP66

ELECTRICAL RATINGS

- Voltages: 100-240 VAC, 127-250 VDC PAGE

OPTIONS AND ACCESSORIES

- Cool white (5000K) and warm white 3000K and 4000K are available
- Frosted lens reduces glare on critical processes
- Mounting: pendant, ceiling, wall, stanchion, trunnion



A long-life, energy-efficient luminaire for general area lighting in hazardous IEC applications

DESIGN FEATURES

- B Rugged design** - Copper-free aluminum housing, tempered and impact-resistant glass globe. Outstanding corrosion-proof capability (C5M-IEC, UL1598A-UL) and anti-vibration design.
- C Surge protection** - 4kV protection as standard, but option up to 10kV surge protection for offshore applications.
- D Robust heat sink** - Innovative heat sink facilitates air flow, ensuring long life in extreme environments.
- E Installation flexibility** - Stanchion, pendant, ceiling, wall and trunnion mount options allow for easy installation in a variety of applications.

Superior optical performance - Cool white 5000K and warm white 3000K and 4000K models available. Narrow (25°) / medium (60°) / wide (120°) beam optics available to distribute the light where it is needed the most.

† Operating temperature range may vary by lumen models within a product family. Refer to product catalog pages for complete temperature range details.



IECEX

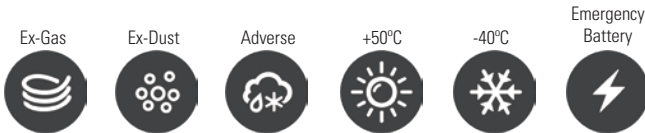

Energy-efficient and globally certified explosionproof workhorse for general area and low/mid bay lighting applications

DESIGN FEATURES

- A Rugged design** - Highly durable aluminum housing with a tempered and impact-resistant glass globe. HPL fixture has an operating temperature range of -40°C to +50°C.
- B Lightweight and compact** - Low profile and lightweight design is ideal for compact installations.
- C Ease of installation** - U-shaped yoke mount provides mounting flexibility - wall, ceiling, pole, etc.

HPL LED light Luminaires

PRIMARY APPLICATIONS

Certified for Zone 1, 2, 21 and 22 hazardous areas. Suitable for mid bay and low bay lighting applications in chemical, petrochemical, pharmaceutical, platforms, shipyards, loading docks, wastewater treatment and paper mills.

LUMINAIRE MODELS

Model number	Equivalent HID luminaire	Typical energy savings/lifetime
HPL 3L	70W-100W	Up to 66% reduction in energy costs
HPL 5L	100W-150W	
HPL 7L	150W-175W	
HPL 8L	150W-175W	

CERTIFICATIONS & COMPLIANCES

- Ex db e mb IIC T6 Gb
- Ex tb IIIC T80°C Db IP66
- Ex tD A21 IP66 T80°C
- IECEx-Certification of Conformity: IECEx CQM 15.0054X
- EC-Type Examination Certificate: EPT 16 ATEX 2405X
- GB Certificate: GYJ15.1157X
- IP66

ELECTRICAL RATINGS

- Voltages: 100-247 VAC, 108-250 VDC
- Input power: 27W, 50W, 70W, 80W

OPTIONS AND ACCESSORIES

- Clear or diffused glass lens
- Warm white (3000K) and cool white (5700K) color temperatures
- Emergency back-up battery available

† Operating temperature range may vary by lumen models within a product family. Refer to product catalog pages for complete temperature range details.



Hazard-Gard™ XPLA/ ZPLA linear LED luminaires

PRIMARY APPLICATIONS

Ideal for Class I, Division 1 and Class II, Division 1 areas in wastewater treatment, oil and gas refineries, drilling rigs, petrochemical facilities, food and beverage facilities, tunnels, outdoor wall and stanchion mounted general area lighting, and where flammable vapors, gases, ignitable dusts, fibers or flyings are present.

LUMINAIRE MODELS

Model number	Equivalent fluorescent luminaire	Typical energy savings/lifetime
XPLA2	2 x 2 ft. T5/T8/T12HO	Up to 62% reduction in energy costs and 60,000 hours of continuous operation!
XPLA4	2 x 4 ft. T5/T8/T12HO	

CERTIFICATIONS & COMPLIANCES

- Class I, Division 1, Groups C, D
- Class II, Division 1, Groups E, F, G
- Class III
- UL50E; UL844; UL924; UL1598; UL1598A; UL8750
- CSA C22.2 No. 137, 250
- NEMA 4X, IP66, Marine and Wet Locations, Paint spray rated

ELECTRICAL RATINGS

- Voltages: 120-277 VAC/127-300 VDC, 347-480 VAC
- Input power: 28.4W, 59.8W, 73.2W (EM model)

OPTIONS AND ACCESSORIES

- Glass or diffused glass lens
- Epoxy paint finish
- Flush, pole and swivel/surface mounts
- Polycarbonate paint spray lens shield kit
- Safety chain kit

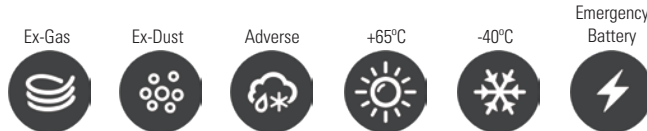

XPLA with emergency battery

Up to 62% more energy-efficient than a T5HO fluorescent light and 8 times the rated life

DESIGN FEATURES

- A High efficacy** - Up to 139 lumens per watt.
- B Custom optics** - Standard wide (120°) beam spread maximizes illumination on wall panels.
- C Built to last** - 2,000 psi high pressure hose down rated; passed 5G vibration test; 60,000 hour lifetime @ 55°C ambient.
- D Slim profile** - Less than 5" fixture height (excluding mounting brackets), perfect for mounting in confined or low height areas.
- F Quick & easy installation** - Easy access to drivers and wiring; no custom brackets or hardware needed; two mounting options available.

Emergency battery back-up - 90-minute minimum run time at 700 lumens in emergency mode.

† Operating temperature range may vary by lumen models within a product family. Refer to product catalog pages for complete temperature range details.



IECEX

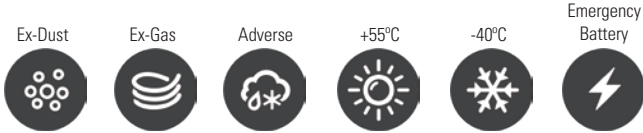

CEAG™ ExLin LED linear luminaires

PRIMARY APPLICATIONS

Approved for use in Zone 1 and 2 hazardous areas, ExLin provides longer life, improved efficiency and superior performance with a competitive payback versus fluorescent fixtures. Designed to provide general illumination where moisture, dust, corrosion and extreme temperature exist.

LUMINAIRE MODELS

Model number	Equivalent fluorescent luminaire	Typical energy savings/lifetime
ExLin 3L-1	2 x 18W	
ExLin 5L-1	2 x 36W	Up to 40% reduction in energy costs and a rated life of 100,000 hours at 25°C
ExLin 5L-2	2 x 36W	
ExLin 7L-2	2 x 58W	
ExLin 10L-2	2 x 58W	

CERTIFICATIONS & COMPLIANCES

Marking accd. to IECEx:

- Ex eb ib op is q IIC T4 Gb
- Ex tb op is IIIC T80/115°C Db

Marking accd. to 2014/34/EU:

- Ex II 2G Ex eb ib op is q IIC T4/T5 Gb
- Ex II 2D Ex tb op is IIIC T80/115°C Db
- IECEx-Certification of Conformity: IECEx BVS 18.0028X
- EC-Type Examination Certificate: BVS 18 ATEX E 037 X
- IP66/67

ELECTRICAL RATINGS

- Voltage: 110-277 VAC/DC
- Input power: 22W, 44W, 67W, 88W

OPTIONS AND ACCESSORIES

- Clear or diffused lens
- Standard, narrow, and wide beam options
- Pole adapter
- Available with V-CG-S emergency lighting technology, allowing the fixtures to be connected to Eaton central emergency lighting system or decentralized solution as ExLinNE+ with highly efficient LiFePO4 battery for 1.5h or 3,h emergency duration without memory effect.

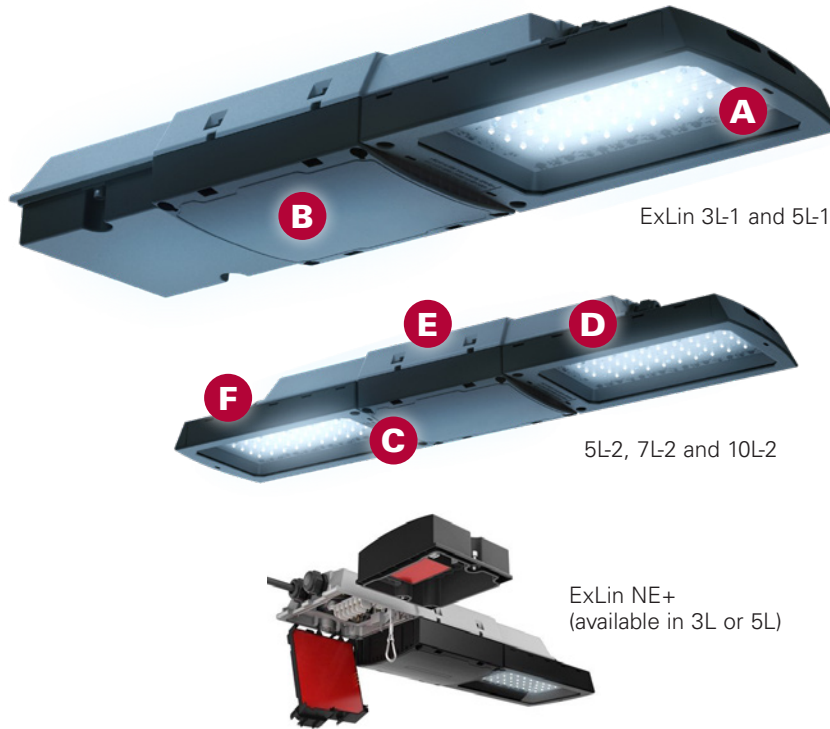

State-of-the-art LED technology with optimized thermal management and a time-tested, field-proven enclosure

DESIGN FEATURES

- A Superior performance and efficiency** - Up to 132 lm/W provides up to 40% energy efficiency compared to traditional fluorescent fixtures.
- B Built to last** - Rated life of 100,000 hours at 25°C based on L90C5 provides long-term, low-maintenance operation.
- C Optimized light distribution** - Standard, narrow and wide beam optics optimize light distribution, providing light where the customer needs it with the potential to reduce the number of fixtures required.
- D Low profile and lightweight** - Decreases footprint in confined applications and reduces installation effort while still providing IK10.
- E Drop-in mounting capability to eLLK fluorescent** - Same fixing point as eLLK 2x18W fixtures and a mounting kit is available, allowing for easy replacement of 2x36W and 2x58W without changing cables.
- F Optimized for offshore applications** - Designed to reduce water condensation for high humidity environments and increase reliability in corrosive environments.

† Operating temperature range may vary by lumen models within a product family. Refer to product catalog pages for complete temperature range details.

CEAG™ eLLK LED linear luminaires

PRIMARY APPLICATIONS

Designed for use in outdoor and indoor hazardous and non-hazardous areas where moisture or corrosion may be a problem, such as offshore oil platforms, pharmaceutical plants, oil refineries and industrial locations.

LUMINAIRE MODELS

Model number	Equivalent luminaire	Battery	Typical energy savings/lifetime
eLLK LED 400A	2 x 18W fluorescent	No	Up to 20% reduction in energy costs and 60,000 hours of continuous operation!
eLLK LED 800A	2 x 36W fluorescent	No	
eLLK LED 400A NE	2 x 18W fluorescent	Yes	
eLLK LED 800A NE	2 x 36W fluorescent	Yes	

CERTIFICATIONS & COMPLIANCES

- II 2G Ex de mb IIC T4 Gb
- II 2D Ex tb IIIC T80°C Db IP66
- BVS 09 ATEX E 034
- Ex de mb IIC T4 Gb/Ex tb IIIC T80°C
- IECEEx BVS 09.0033

ELECTRICAL RATINGS

- Voltages: 110-254 VAC, 110-250 VDC
- Input power: 2x13W, 2x26W

OPTIONS AND ACCESSORIES

- LED module 400A (2x13W) for eLLK/M 92 018/18
- LED module 800A (2x26W) for eLLK/M 92 036/36
- Self-contained battery system (NE models)
- Available with V-CG-S module for monitoring with an Eaton central battery system

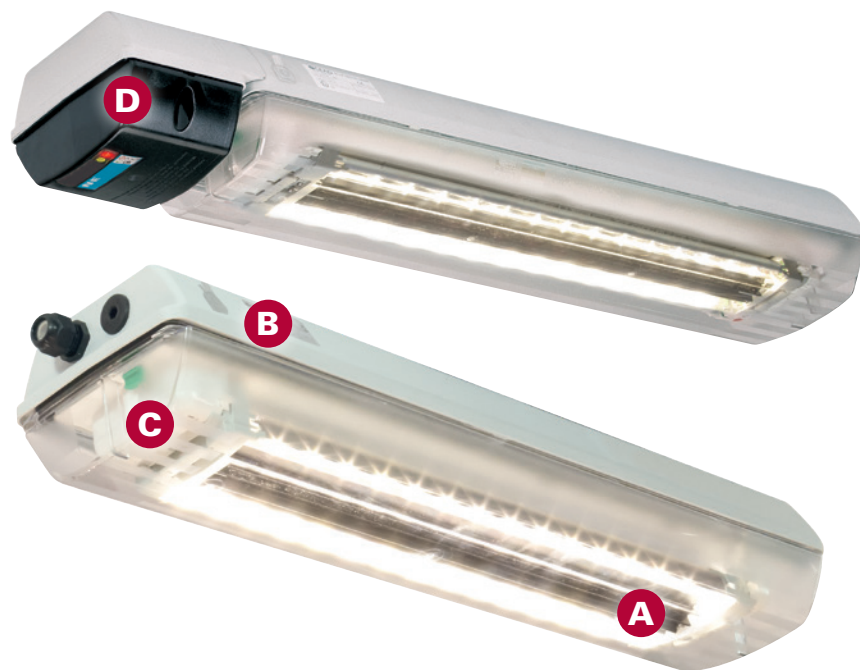

Saves on energy consumption and easily retrofit existing luminaires in hazardous and corrosive environments

DESIGN FEATURES

- A High output** - Illuminance (lux/Fc) equivalent to related fluorescent tubes at measurement plane.
- B Non-metallic design** - Fiberglass-reinforced polyester construction for extreme durability.
- C Retrofit friendly** - Retrofits to existing eLLK/nLLK fixtures with existing EVG 09 ballast or as a complete unit.
- D Emergency** - eLLK NE models include a 7 Ah-NC battery with LED display and monitoring via microprocessor. Provides 1.5 or 3 hours of emergency lighting.

† Operating temperature range may vary by lumen models within a product family. Refer to product catalog pages for complete temperature range details.



IECEX

Ex-Gas



Ex-Dust



Adverse



+55°C



-40°C



Emergency Battery



Rugged, low profile fixture that is easy to install and provides clear illumination in Zone 1, 2, 21 and 22 hazardous areas

DESIGN FEATURES

- A Rugged design** - Copper-free aluminum housing and impact-resistant polycarbonate lens provide excellent resistance to corrosion and heat.
- B Easy installation** - Lightweight design, hinged cover, and a terminal block wing for easy installation and maintenance.
- C Industry-leading thermal management** - For safe and reliable operation over a wide temperature range.
- D Retrofit friendly** - Fixture utilizes the same mounting footprint of linear fluorescent lighting.

† Operating temperature range may vary by lumen models within a product family. Refer to product catalog pages for complete temperature range details.

HLL LED linear luminaires

PRIMARY APPLICATIONS

Constructed with an aluminum housing and high impact-resistant polycarbonate cover, providing extreme durability and reliability in Zone 1, 2, 21 and 22 hazardous areas. Designed for use in hazardous areas where moisture or corrosion may be a problem, such as offshore oil platforms, pharmaceutical and chemical plants, oil refineries and industrial locations.

LUMINAIRE MODELS

Model number	Equivalent luminaire	Typical energy savings/lifetime
HLL-2-3L	2 x 18W	Up to 39% reduction in energy costs and 50,000 hours of continuous operation!
HLL-4-5L	2 x 36W	

CERTIFICATIONS & COMPLIANCES

- Ex db eb mb IIC T6 Gb
- Ex db eb ib mb IIC T6 Gb
- Ex tb IIIC T80°C Db IP66†
- Ex tb IIIC T80°C Db
- IECEx-certification of conformity: IECEx NEP 19.0003X
- EC-Type examination certificate: SEV 20 ATEX 0379 X
- IP66

ELECTRICAL RATINGS

- Voltages: 100-240 VAC, 108-250 VDC
- Input power: 30W, 60W

OPTIONS AND ACCESSORIES

- Epoxy coating on aluminum housing
- Emergency battery back-up
- Pipe, wall, and ceiling mounts available

HRL LED recessed linear luminaires

PRIMARY APPLICATIONS

Engineered to provide maintenance-free illumination in the most demanding environments, along with a competitive payback vs. fluorescent fixtures. Available in three common sizes, the HRL is certified for use in Zones 1, 2, 21 and 22 hazardous areas, as well as Class I, Division 2 locations.

LUMINAIRE MODELS

Model number	Equivalent luminaire	Battery	Typical energy savings/lifetime
HRL3060	2 x 18W fluorescent	Yes	Up to 20% reduction in energy costs and 55,000 hours of continuous operation!
HRL3012	2 x 36W fluorescent	Yes	
HRL6060	4 x 18W fluorescent	Yes	

CERTIFICATIONS & COMPLIANCES

- IP66
- Ex eb mb IIC T6...T5 Gb
- Ex eb ib mb IIC T6 Gb
- Ex tb IIIC T80 °C Db
- IECEX SEV 19.0001X
- SEV 19 ATEX 0101 X

ELECTRICAL RATINGS

- Voltages: 110-240 VAC, 108-250 VDC
- Input power: 28W, 54W

OPTIONS AND ACCESSORIES

- 90 and 180 minute battery back-up options
- Galvanized or stainless steel enclosure
- Safety switch
- Single or through feed wiring
- Painted sheet steel or stainless steel housing

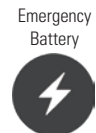

Maintenance-free illumination in the most demanding environments

DESIGN FEATURES

- A High output** - 3 models from 3000 to 6,000 lumens with up to 110 lm/W.
- B Rugged design** - Painted steel or optional stainless steel construction for reliable performance in extreme environments.
- C Retrofit friendly** - Recessed mounting in existing T-bar ceiling systems.
- D Emergency** - Battery back-up function provides 1.5 or 3 hours of emergency lighting.

† Operating temperature range may vary by lumen models within a product family. Refer to product catalog pages for complete temperature range details.

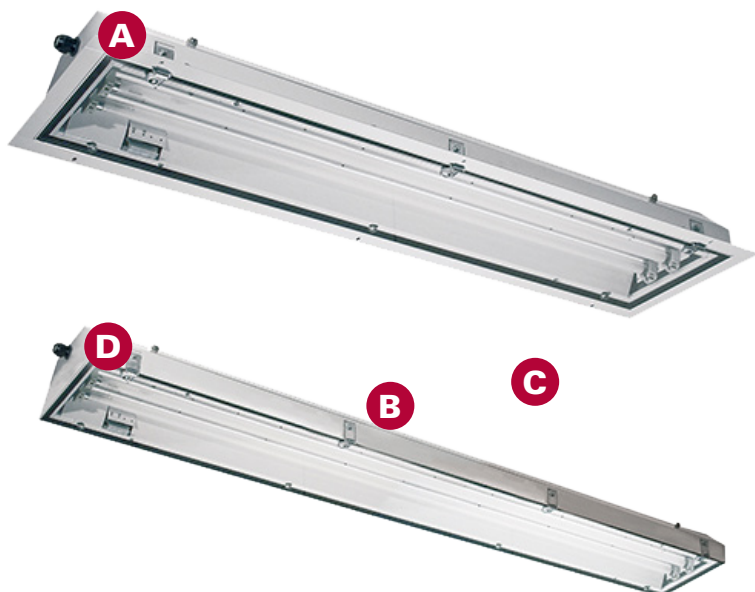
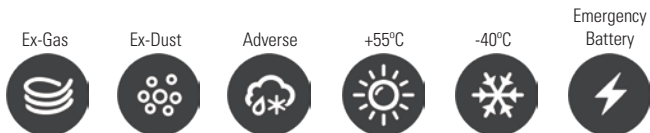

Explosion-protected, recessed ceiling lighting engineered for Zone 1, 2, 21 and 22 hazardous areas.

DESIGN FEATURES

- A Rugged design** - Painted sheet steel or optional stainless steel housing for easy cleanup and safety glass lens.
- B Easy installation** - Installs flush, ideal for paint shops and spray booths.
- C Maximum flexibility** - 3,000 to 13,000 lumen range over four models and two fixture sizes.
- D Safety** - Self-contained battery unit with 1.5 to 3 hours of runtime optional (battery range based upon select models).

RLF LED is 4000K CRI80 and 6000K CRI80

RLF LED linear luminaires

PRIMARY APPLICATIONS

RLF LED linear recessed ceiling fixtures provide extreme durability and reliability in Zone 1, 2, 21 and 22 hazardous areas. The RLF is designed for use in hazardous areas such as paint shops and spray cabinets, pharmaceutical and chemical plants.

LUMINAIRE MODELS

Model number	Equivalent luminaire	Typical energy savings/lifetime
RLF LED A 600 3L	2 x 18W	Up to 39% reduction in energy costs and 50,000 hours of continuous operation!
RLF LED A 600 7L	2 x 36W	
RLF LED A 1200 7L	2 x 36W	
RLF LED A 1200 13L	2 x 58W	

CERTIFICATIONS & COMPLIANCES

- Ex II 2G Ex eb mb op is IIC T4 Gb
- Ex II 2 D Ex tb IIIC T67°C Db
- EU-Type Examination Certificate: FTZU 17 ATEX 0002X
- IP65

ELECTRICAL RATINGS

- Voltages: 110-254 VAC, 220-250 VDC
- Input power: 40W, 80W

OPTIONS AND ACCESSORIES

- Painted sheet steel or optional stainless steel housing
- Emergency battery back-up
- Pipe, wall, and ceiling mounts available

† Operating temperature range may vary by lumen models within a product family. Refer to product catalog pages for complete temperature range details.

VLL linear LED luminaires

PRIMARY APPLICATIONS

Designed for use in outdoor and indoor hazardous and non-hazardous areas where moisture or corrosion may be a problem, such as offshore oil platforms, pharmaceutical plants, oil refineries and industrial locations.

LUMINAIRE MODELS

Model number	Equivalent luminaire	Typical energy savings/lifetime
VLL-3L	2 x 18W fluorescent	Up to 20% reduction in energy costs and 60,000 hours of continuous operation!
VLL-5L	2 x 36W fluorescent	
VLL-7L	2 x 54W fluorescent	

CERTIFICATIONS & COMPLIANCES

- IP66
- Marking accd.to IECEx
- Ex eb mb IIC T5 Gb or Ex db eb mb IIC T5 Gb / Ex db eb ib mb IIC T5Gb (EM)
- Ex tb IIIC T80°C Db

Marking accd.to ATEX

- II2 G Ex eb mb IIC T5 Gb
- II2 G Ex db eb mb IIC T5 Gb
- II2 G Ex db eb ib mb IIC T5 Gb(EM)
- II2 D Ex tb IIIC T80°C Db

ELECTRICAL RATINGS

- Voltages: 100-240 VAC, 105-250 VDC
- Input power: 25W, 50W, 60W

OPTIONS AND ACCESSORIES

- 5700K cold white, optional 3000K warm, 4000K neutral or 5000K cool white
- Self-contained battery system
- Self-monitoring battery indicator system
- Diffused polycarbonate lens standard

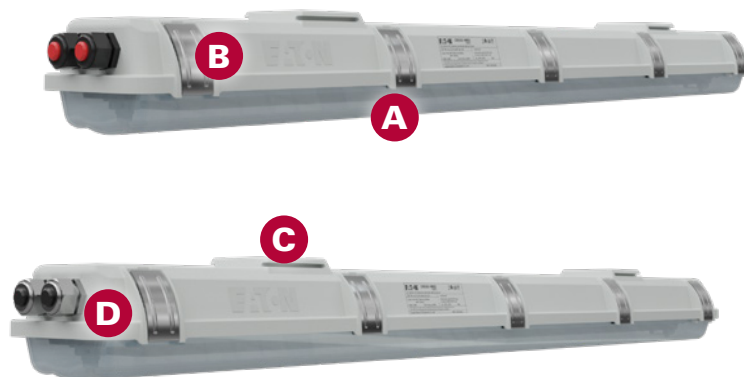

Saves on energy consumption and easily retrofit existing luminaires in hazardous and corrosive environments

DESIGN FEATURES

- A High output** - 3 models from 3,100 - 7,400 lumens with up to 130lm/W.
- B Non-metallic design** - Fiberglass-reinforced polyester construction for extreme durability.
- C Retrofit friendly** - Optional sliding rail mount system to easily adjust to previous mounting position.
- D Emergency** - Battery back-up function provides 1.5 or 3 hours of emergency lighting.

† Operating temperature range may vary by lumen models within a product family. Refer to product catalog pages for complete temperature range details.



IECEX



AB05 LED wallpack

PRIMARY APPLICATIONS

Perfect for confined or restricted spaces, such as stairwells, storage areas and corridors that require consistent light.

LUMINAIRE MODELS

Model number	Equivalent luminaire	Typical energy savings/lifetime
AB05	150W incandescent	Up to 80% reduction in energy costs and 60,000 hours of continuous operation!

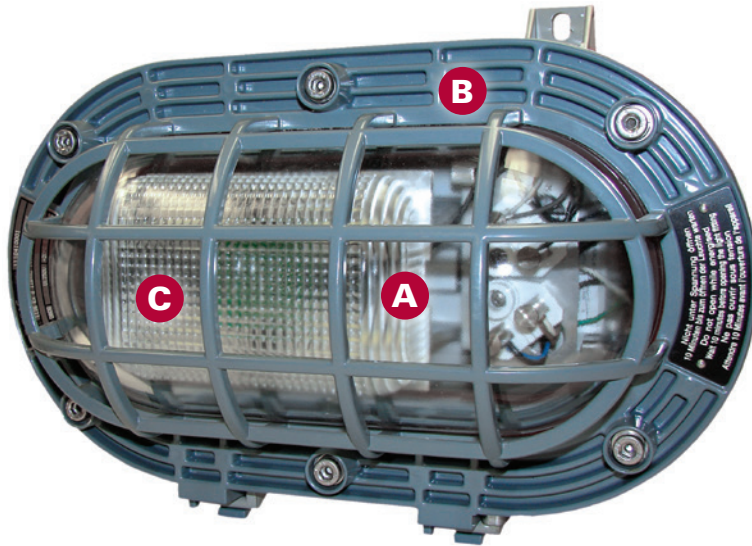

Up to 6 times longer life and 65% reduction in power consumption compared to equivalent HID floodlights

DESIGN FEATURES

- A Shock- and vibration-resistant** - Durable vibration-resistant LEDs decrease maintenance costs.
- B Lightweight enclosure** - Robust light alloy enclosure weighs only 7.0 kg, allowing the user to mount in areas where the available space is restricted, and making installation fast and easy.
- C Instant illumination and restrike** - Decreases facility downtime; no warm-up time required.

CERTIFICATIONS & COMPLIANCES

- Zone 1, 2, 21, 22
- Ex d IIB T6
- Ex II 2 G Ex d IIB T6/T5 Gb
- Ex II 2 D Ex tb IIIC T80°C/T100°C Db
- Certificate BVS 09 ATEX E 014 X
- IP66

ELECTRICAL RATINGS

- Voltage: 230 VAC
- Input power: 23W

† Operating temperature range may vary by lumen models within a product family. Refer to product catalog pages for complete temperature range details.

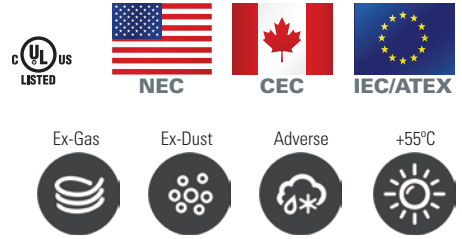

Hazard-Gard™ EV LED light fixtures

PRIMARY APPLICATIONS

Indoors or outdoors in process and storage areas, corridors, bridges and stairs.

LUMINAIRE MODELS

Model number	Equivalent luminaire	Typical energy savings/lifetime
EVLEDC201	100W-200W incandescent	Up to 85% reduction in energy costs and 50,000 hours of continuous operation!
EVLEDC701	70W-100W HID	

CERTIFICATIONS & COMPLIANCES

- Class I, Division 1, Groups C, D
- Class I, Zones 1 & 2, Group IIB
- Class II, Division 1, Groups E, F, G
- Class III; Simultaneous Presence
- UL844; UL1598; UL1598A
- CSA C22.2 No. 137
- Type 4X, IP66

ELECTRICAL RATINGS

- Voltages: 100-277 VAC
- Input power: 15W, 30W

OPTIONS AND ACCESSORIES

- Amber color for wildlife-friendly applications
- Color temperature: cool white (3000K) and warm white (5600K)
- 12-24 VDC



Up to 85% reduction in energy costs and 50,000 hours of continuous operation

DESIGN FEATURES

- A Retrofittable mounting modules** - Compatible with existing EV Series mounting modules, which reduces retrofit installation time and materials costs, and makes new construction installation easy.
- B 20 times longer life than incandescents in tough-to-maintain Division 1 locations.**

† Operating temperature range may vary by lumen models within a product family. Refer to product catalog pages for complete temperature range details.



Adverse

+55°C

-40°C

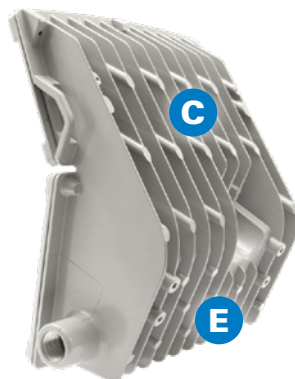
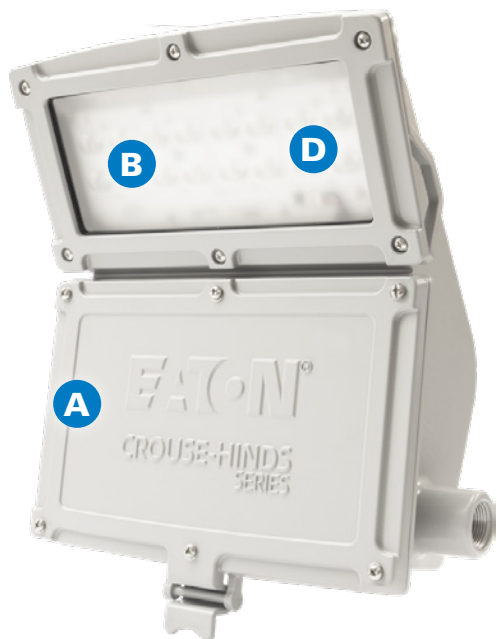

Industry-leading performance and reliability for outdoor area and site lighting in industrial locations

DESIGN FEATURES

- A Built to last** - Rated for 60,000+ hours of operation at 55°C. Impact-resistant lens sealed from the outside environment provides ingress protection against water and dust. Easily removable cover allows for field serviceable driver maintenance.
- B High efficiency** - Up to 116 lumens per watt.
- C Rugged design** - Engineered to perform in ambient temperatures from -40°C to +55°C. Die cast aluminum LED housing provides efficient thermal path to heat sink assembly, and vertical fin design facilitates air flow and dust shedding.
- D Multiple optic and lens options** - Narrow and wide optics for ideal light output. Four lens styles provide flexibility for specific applications and customer preferences.
- E Simple installation** - Contractor-friendly design is ideal for both retrofit and new construction. Available with lever lock connectors.

Champ™ Pro WPMV LED wallpack light fixtures

PRIMARY APPLICATIONS

Provides a low profile solution for industrial lighting applications. It's the ideal choice for vertical surface lighting where harsh conditions require high quality, reliable illumination.

LUMINAIRE MODELS

Model number	Equivalent HID luminaire	Typical energy savings/lifetime
WPMV3L	70W	Up to 70% reduction in energy costs and 60,000 hours of continuous operation!
WPMV5L	100W	
WPMV7L	150W-175W	

CERTIFICATIONS & COMPLIANCES

- UL1598; UL1598A; UL8750
- CSA C22.2 No. 250
- NEMA 4X, IP66, Marine and Wet Locations

ELECTRICAL RATINGS

- Voltages: 120-277 VAC/125/250 VDC, 347-480 VAC
- Input power: 30W, 45W, 57W

OPTIONS AND ACCESSORIES

- Available with a variety of lens types, including clear glass, diffused glass, clear polycarbonate and diffused polycarbonate
- Yoke mount and hub mount options are available
- Available with a photocell

† Operating temperature range may vary by lumen models within a product family. Refer to product catalog pages for complete temperature range details.

Champ™ Pro PFMA LED floodlights

PRIMARY APPLICATIONS

Indoor and outdoor area lighting in manufacturing plants, mine sites and processing areas, platforms, loading docks and parking areas.

LUMINAIRE MODELS

Model number	Equivalent HID luminaire	Typical energy savings/lifetime
PFMA3L	70W	Up to 78% reduction in energy costs and 150,000 hours of continuous operation!
PFMA5L	100W	
PFMA7L	175W	
PFMA9L	250W	
PFMA11L	320W	
PFMA13L	400W	
PFMA15L	500W	
PFMA20L	600W-750W	
PFMA25L	750W-1000W	
PFMA40L	1,500W+	
PFMA50L	1,500W+	

CERTIFICATIONS & COMPLIANCES

- UL1598; UL1598A; UL50E
- cUL
- Type 4X
- IP66
- UL approved up to 65°C ambient (3L-15L)
- cUL Listed to CSA Standard CSA C22.2 No. 250
- IEC Standards: IEC 60598; CE (20L-50L)

ELECTRICAL RATINGS

- Voltages: 100-277 VAC/125-250 VDC, 347-480 VAC
- Input power: 31W, 45W, 59W, 58W, 75W, 90W, 105W, 177W, 217W, 340W, 400W

OPTIONS AND ACCESSORIES

- Bolt-on visor and bolt-on wire guard (not available on 9L-15L)
- Floodlight slipfitter (not available on 40L & 50L)
- Slipfitter wall mount adapter (not available on 40L & 50L)
- Polycarbonate lens (not available on 20L-50L)
- Diffused glass
- Bull horn
- 6x6 (3-7L models), 7x6 & 3x3 (9-50L models)

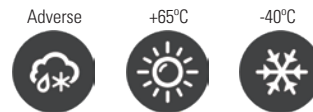

Up to 6 times longer life and up to 78% reduction in power consumption compared to equivalent HID floodlights

DESIGN FEATURES

- A Versatile design** - Can be used for outdoor or indoor applications, and for a wide range of mounting heights depending on model and light level requirement.
- B Rugged heat sink** - Designed to perform in high ambient temperatures up to +65°C and as low as -40°C. The thick walls of the castings make for a tough, rugged housing that keeps the internal driver and LED temperatures down.
- C High lumen output** - Up to 162 lumens per watt.
- D Full-frame yoke** - Designed to utilize the SFA6 slipfitter and SWB6 wall mount bracket, making it ideal for retrofit or new installations (not available for 40L & 50L).
- E Multiple lens options** - Tempered and clear glass standard, polycarbonate and diffused glass options available.
- F Smaller and lighter** - FMVA-3 through FMVA-7 units are 20lbs lighter than previous models (3L-25L model). FMVA-9 through FMVA-15 units are 10lbs lighter than previous models (3L-25L model).
- G Serviceable** - Driver and LED engine are field replaceable for extended life even beyond the warranty (FMVA-9 through FMVA-15 only).

† Operating temperature range may vary by lumen models within a product family. Refer to product catalog pages for complete temperature range details.



Adverse

+65°C

-40°C

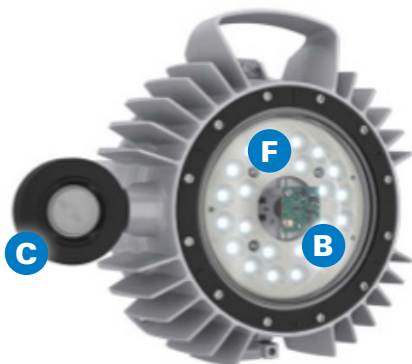

Available with an integral battery back-up for emergency lighting applications!

VMVL-17 – VMVL-25

Custom Type I, III and V optics for better output, zero maintenance and reduced energy consumption

DESIGN FEATURES

- A Modular design** - This contractor-friendly design is ideal for both retrofit and new construction applications.
- B Integrated antenna** - Enables effortless connection to our Brightlayer Industrial lighting control interface. No complex hardware required to commission and control the lights. Bluetooth Low Energy (BLE) protocol enables decentralized control of the system without complex and expensive IT network infrastructure - up to 100-foot range fixture-to-fixture.
- C Intelligent multi-sensor** - Replaceable sensor can be factory installed or field installed at a later date (sensor is integral to light fixture - no field wiring required). PIR occupancy sensor to automatically illuminate areas once presence is detected and photo sensing for daylight harvesting and lux reporting.
- D Type 4X Rated** - The LED housing is constructed of durable die cast aluminum, providing an efficient thermal path to the heat sink assembly. The impact-resistant lens is sealed from the outside environment and provides ingress protection against water and dust.
- E Safe, reliable heat transfer** - Die cast aluminum housing provides safe and effective heat transfer from the LED assembly to the outside environment, ensuring low LED junction temperature, reliability and sustained lumen performance.
- F Custom optics and colors** - Directs light where you need it, helping eliminate gaps and dark spots which can potentially reduce the number of light fixtures required in specific applications. Green and amber LEDs available for wildlife conservation applications.

Champ™ Pro PVML

LED light fixtures

PRIMARY APPLICATIONS

Locations requiring continuous and consistent light levels in extreme ambient temperatures, such as manufacturing plants, mine sites, heavy industrial or petrochemical facilities, food and beverage facilities, marine environments, platforms, loading docks, tunnels, outdoor wall and stanchion mounted general area lighting.

LUMINAIRE MODELS

Model number	Equivalent HID luminaire	Typical energy savings/lifetime
PVML-3	70W	Up to 77% reduction in energy costs and 60,000 hours of continuous operation!
PVML-5	100W	
PVML-7	175W	
PVML-9	250W	
PVML-11	320W	
PVML-13	400W	
PVML-17	400W-600W	
PVML-21	600W-750W	
PVML-25	750W-1,000W	

CERTIFICATIONS & COMPLIANCES

- UL1598; UL1598A
- cUL
- Type 4X, IP66, Wet Locations
- cUL Listed to CSA Standard CSA C22.2 No. 250
- IEC standard: CE
- UL approved up to 65°C ambient (3L-11L UNV1; all other models 55°C)

ELECTRICAL RATINGS

- Voltages: 100-277 VAC/127-250 VDC, 347-480 VAC
- Input power: 28W, 45W, 61W, 76W, 92W, 95W, 133W, 165W, 199W

OPTIONS AND ACCESSORIES

- Integral back-up battery (90 minutes of emergency lighting, PVML-3 to PVML-13 only)
- Quick Clip to simplify installation
- Diffused lens, Teflon coated lens, polycarbonate lens and upright refractor lens
- Wire guard
- Trunnion mount
- Cone top hat
- Type I, III and V optics (PVML-3 to PVML-13 only)
- Occupancy sensor and remote

† Operating temperature range may vary by lumen models within a product family. Refer to product catalog pages for complete temperature range details.

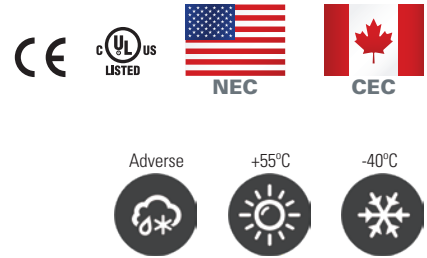

Champ™ Pro PVMA LED light fixtures

PRIMARY APPLICATIONS

Ideal for a variety of non-hazardous medium or heavy duty applications such as mining, marine, food processing, pulp and paper, wastewater treatment, power generation, and general industrial manufacturing areas.

LUMINAIRE MODELS

Model number	Equivalent HID luminaire	Typical energy savings/lifetime
PVMA5L	150W	Up to 77% reduction in energy costs and 60,000 hours of continuous operation!
PVMA75L	175W	

CERTIFICATIONS & COMPLIANCES

- UL1598; UL1598A
- CSA C22.2 No. 250
- IP66, Wet Locations
- RoHS
- IEC Standards: IEC 60598; CE

ELECTRICAL RATINGS

- Voltages: 120-277 VAC/127-300 VDC (5L UNV1 models only), 347-480 VAC
- Input power: 48W, 64W

OPTIONS AND ACCESSORIES

- Ceiling, pendant, cone pendant, wall, and trunnion mounts
- Safety cable
- Quick Clip
- Clear or diffused glass, clear or diffused polycarbonate and upright refractor lenses
- Wire guards (standard & upright globe compatible guards available)

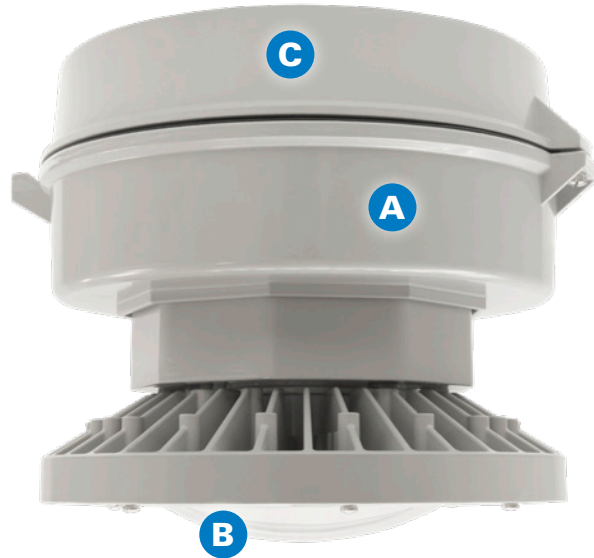

Smaller footprint, lightweight design, and maintenance-free illumination in demanding environments

DESIGN FEATURES

- A Rugged design** - Engineered for durability in complex environments.
- B High efficiency** - Up to 122 lm/W and custom optics to maximize light on the work plane.
- C Ease of installation** - Compact footprint with ceiling, pendant, wall or stanchion mount options and the ability to retrofit Crouse-Hinds series installed base.

† Operating temperature range may vary by lumen models within a product family. Refer to product catalog pages for complete temperature range details.

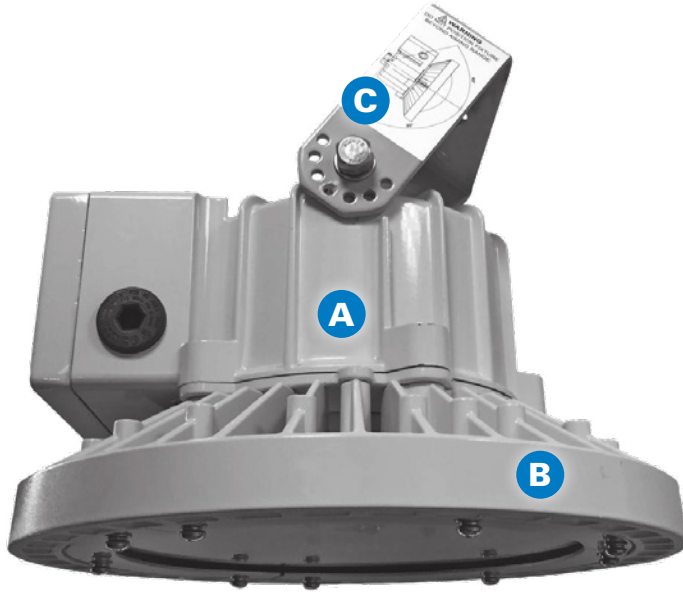

Low profile and lightweight design, easy to install and reliable illumination in demanding environments

DESIGN FEATURES

- A Rugged design** - Highly durable aluminum housing with a tempered and impact-resistant glass globe. PLE fixture has an operating temperature range of -40°C to +55°C.
- B Lightweight and compact** - Low profile and lightweight design is ideal for compact installations.
- C Ease of installation** - U-shaped yoke mount provides mounting flexibility - wall, ceiling, pole, etc.

† Operating temperature range may vary by lumen models within a product family. Refer to product catalog pages for complete temperature range details.

PLE LED light fixtures

PRIMARY APPLICATIONS

Ideal for a variety of non-hazardous medium or heavy duty applications such as mining, platforms, loading docks, tunnels, and general industrial manufacturing areas.

LUMINAIRE MODELS

Model number	Equivalent HID luminaire	Typical energy savings/lifetime
PLE-3L	70W-100W	
PLE-5L	100W-150W	Up to 66% reduction in energy costs
PLE-7L	150W-175W	
PLE-8L	150W-175W	

CERTIFICATIONS & COMPLIANCES

- IEC Standard: CE
- IP66

ELECTRICAL RATINGS

- Voltages: 100-240 VAC, 108-250 VDC
- Input power: 30W, 50W, 70W, 80W

OPTIONS AND ACCESSORIES

- Emergency battery
- Clear or diffused glass lens
- Warm white (3000K) and cool white (5700K) color temperatures

Champ™ Pro PLLA LED linear light fixtures

PRIMARY APPLICATIONS

Ideal for a variety of non-hazardous applications such as mining, food processing, marine, wastewater treatment, heavy manufacturing and general wash down areas.

LUMINAIRE MODELS

Model number	Equivalent fluorescent luminaire	Typical energy savings/lifetime
PLLA2	2 x 2 ft. T5/T8/T12HO	Up to 67% reduction in energy costs and 60,000 hours of continuous operation!
PLLA4	2 x 4 ft. T5/T8/T12HO	

CERTIFICATIONS & COMPLIANCES

- UL1598; UL1598A; UL8750; UL924
- CSA C22.2 Nos. 141, 250
- Type 4X, IP66/67, Marine and Wet Locations

ELECTRICAL RATINGS

- Voltages: 120-277 VAC/127-250 VDC, 347-480 VAC
- Input power: 30.3W, 58.9W

OPTIONS AND ACCESSORIES

- Available with a self-contained battery system for emergency lighting applications
- Clear or diffused polycarbonate lens
- Flush/back, ceiling/swivel, wall, offset ceiling/wall, pole and pendant mounts
- Safety chain kit
- Epoxy painted or natural aluminum finish
- Emergency back-up battery option
- Surge protection module
- Standard through feed - up to 8 lights

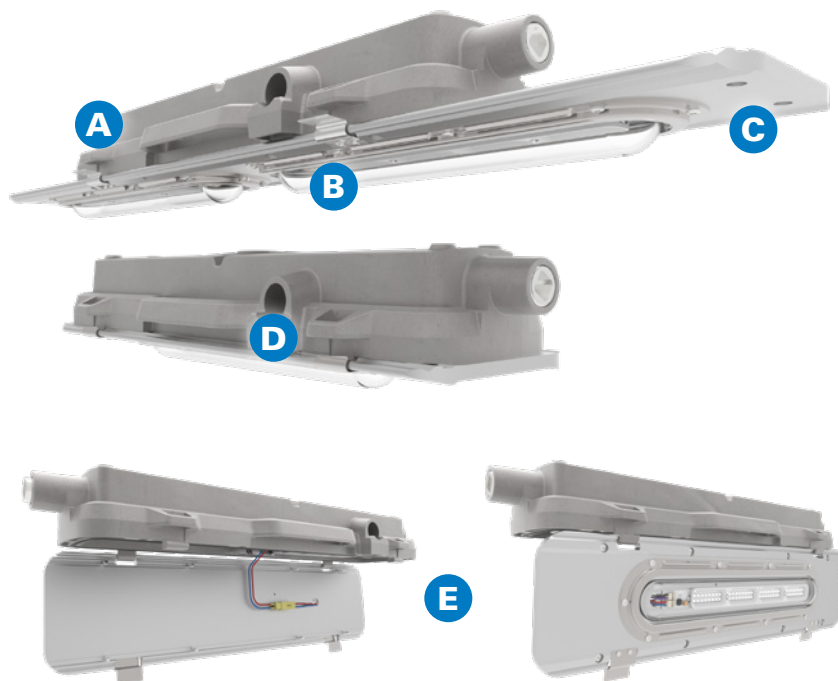
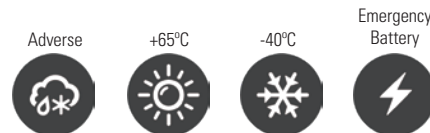

Up to 67% more energy efficient than a T5HO fluorescent light and 8 times the rated life

DESIGN FEATURES

- A Best-in-class efficacy** - Up to 134 lumens per watt.
- B Custom optics** - Standard wide (120°) and narrow (80°) beam pattern for a wide variety of general and targeted lighting applications.
- C Built to last** - 2,000 psi high pressure hose down rated; high vibration resistant; 60,000 hour lifetime at 55°C ambient.
- D Slim profile** - 4.4" fixture height (excluding mounting brackets), perfect for mounting in confined or low height areas.
- E Serviceable driver and light engine** - easy access to drivers for wiring and field replaceable light engines available.

† Operating temperature range may vary by lumen models within a product family. Refer to product catalog pages for complete temperature range details.



Adverse

+55°C

-40°C



NSF Splash Zone rated, 1500 psi hose down tested and an angled housing to mitigate debris build-up

DESIGN FEATURES

- A Innovative and robust design** - Angled light fixture mitigates debris build-up. Withstands 1500 psi high pressure wash down, and food rated paint maintains safety.
- B High performance optics and drivers** - 100+ lumens per watt provides highly efficient lighting. Rated life is up to 60,000 hours of maintenance-free and safe operation.
- C Easily customized for application-specific performance** - Versatile mounting options with a through feed design for simplified multiple fixture wiring.

† Operating temperature range may vary by lumen models within a product family. Refer to product catalog pages for complete temperature range details.

Harsh & heavy industrial Linear

Pauluhn™ Apex LED linear light fixtures

PRIMARY APPLICATIONS

Replaces fluorescent T12, T8, and T5HO fixtures in hose down, corrosive and heavy industrial environments.

The Apex LED was designed with food and beverage processing facilities in mind. The fixture housing is angled to mitigate debris build-up and features a food rated epoxy powder coat finish. Plus, its robust design can withstand 1,500 psi hose pressure for wash down applications.

LUMINAIRE MODELS

Model number	Equivalent luminaire	Typical energy savings/lifetime
APX13L	3 lamp T5HO	Up to 50% reduction in energy costs and minimum 60,000 hours of continuous operation!
APX17L	4 lamp T5HO	
APX25L	6 lamp T5HO	

CERTIFICATIONS & COMPLIANCES

- UL1598; UL8750
- CSA 22.2 No. 250
- NSF Splash Zone
- Type 4X; IP66

ELECTRICAL RATINGS

- Voltages: 120-277 VAC/127-250 VDC, 347-480 VAC
- Input power: 122W, 144W, 217W

OPTIONS AND ACCESSORIES

- Clear or diffused polycarbonate lens
- Optional 0-10V dimming capabilities
- Surface/swivel mount, cable/chain mount and threaded rod mount
- Available with cord assemblies and quick disconnect receptacle

Pauluhn™ FPS LED linear light fixtures

PRIMARY APPLICATIONS

A low/mid bay linear LED fixture for industrial and marine locations. The FPS is available with a non-metallic housing and is Type 4X / IP66 rated for moisture protection in hose down and marine applications.

LUMINAIRE MODELS

Model number	Equivalent fluorescent luminaire	Typical energy savings/lifetime
FPS2L	2x2 ft. T8	Up to 63% reduction in energy costs and 60,000 hours of continuous operation!
FPS4L	2x4 ft. T8	

CERTIFICATIONS & COMPLIANCES

- UL1598; UL1598A; UL924
- CSA C22.2 No. 250
- Type 4X
- IP66
- NSF Splash Zone

ELECTRICAL RATINGS

- Voltage: 120-277 VAC
- Input power: 27W, 37W (EM model), 78W

OPTIONS AND ACCESSORIES

- Red and blue color LEDs for naval applications
- Emergency battery back-up
- Surface and pole mounts



Adverse



+50°C



Emergency Battery

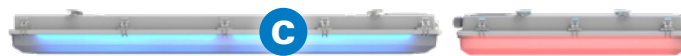

A non-metallic, corrosion-resistant LED fixture designed for hose down and marine applications

DESIGN FEATURES

- A Built to last** - Non-metallic housing and stainless steel mounts and latches provide excellent resistance to corrosion.
- B Low-glare design** - Diffused lens minimizes glare in low mounting height applications.
- C Color LED options** - Available with red or blue LEDs for naval or emergency applications.
- D Installation-friendly** - Versatile options for terminal blocks and through feed.
- E Emergency** - Available with a self-contained battery system for emergency power loss applications.

† Operating temperature range may vary by lumen models within a product family. Refer to product catalog pages for complete temperature range details.



Adverse



+55°C



-40°C



Emergency
Battery

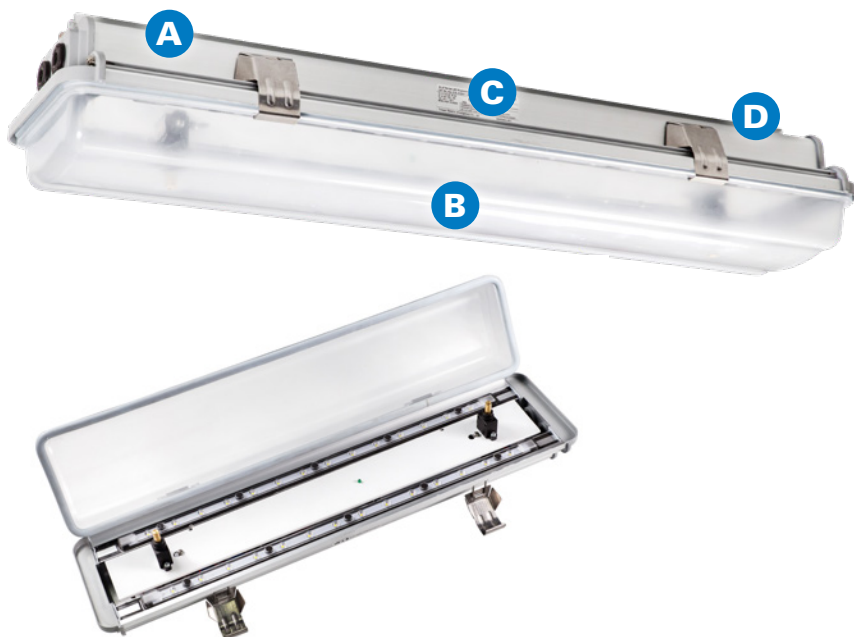

Rugged, low profile fixture that is easy to install and provides clear illumination in challenging areas

DESIGN FEATURES

- A Rugged design** - Copper-free aluminum housing and impact-resistant polycarbonate lens provide excellent resistance to corrosion and heat.
- B Easy installation** - Lightweight design, hinged cover, and a terminal block wing for easy installation and maintenance.
- C Industry-leading thermal management** - For safe and reliable operation over a wide temperature range.
- D Retrofit friendly** - Fixture utilizes the same mounting footprint of linear fluorescent lighting.

PLLE LED linear light fixtures

PRIMARY APPLICATIONS

Constructed with an aluminum housing and high impact-resistant polycarbonate cover for use in outdoor and indoor industrial areas where moisture or corrosion may be a problem, such as offshore oil platforms, pharmaceutical and chemical plants, oil refineries and industrial locations.

LUMINAIRE MODELS

Model number	Equivalent fluorescent luminaire	Typical energy savings/lifetime
PLLE-2-C2-3L	2 x 18W	Up to 39% reduction in energy costs and 50,000 hours of continuous operation!
PLLE-2-C2-4L	2 x 36W	
PLLE-4-C2-5L	2 x 36W	
PLLE-4-C2-8L	2 x 58W	

CERTIFICATIONS & COMPLIANCES

- CE self declared
- IP66

ELECTRICAL RATINGS

- Voltage: 100-240 VAC
- Input power: 30W, 40W, 60W, 80W

OPTIONS AND ACCESSORIES

- Epoxy coating on aluminum housing
- Emergency battery back-up
- Pipe, wall, and ceiling mounts available

† Operating temperature range may vary by lumen models within a product family. Refer to product catalog pages for complete temperature range details.

CEAG™ LLK15 LED linear light fixtures

PRIMARY APPLICATIONS

Crisp, bright light and durability in wet and harsh environments. Wide ambient temperature range from -40° to +55°C. Heavy duty, non-metallic construction stands up to dust, dirt, gas, vapor, smoke, fumes, moisture, corrosive and wet conditions.

LUMINAIRE MODELS

Model number	Equivalent fluorescent luminaire	Typical energy savings/lifetime
LLK15 LED 600	2 x 18W	Up to 60% more efficient than fluorescent light fixtures
LLK15 LED 1200	2 x 36W	
LLK15 LED 1500	2 x 58W	

CERTIFICATIONS & COMPLIANCES

- IP66
- Operating temperature range -40°C to +55°C

ELECTRICAL RATINGS

- Voltage: 220-240 VAC
- Input power: 18W, 37W, 49W

OPTIONS AND ACCESSORIES

- Available with safety switch on request
- Wall mount brackets, ceiling mount brackets and pipe clamps
- Available with battery
- Available with V-CG-S module for monitoring with an Eaton central battery system
- Available with DALI

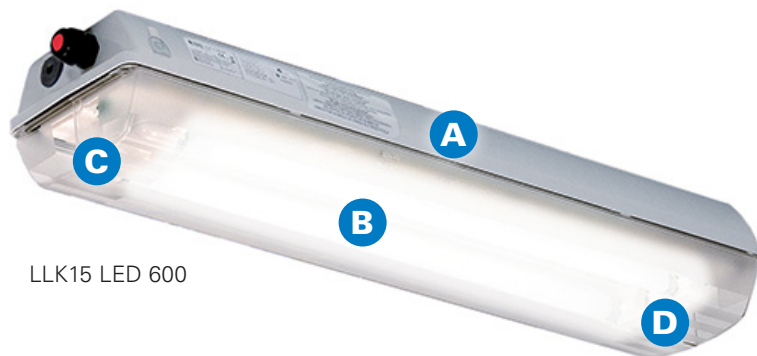
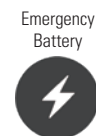

LLK15 LED 600



LLK15 LED 1200 and 1500

A rugged and durable LED fixture designed for reliable performance in extreme ambient temperatures

DESIGN FEATURES

- A Built to last** - Heavy duty, non-metallic construction stands up to tough physical and environmental demands, making it an excellent choice where dust, dirt, gas, vapor, smoke, fumes, moisture, corrosive and wet conditions are present.
- B High output** - Utilizes long-life LED tubes for extreme applications, providing high efficacy and long life.
- C Extreme temperatures** - Rated for use in ambient temperatures from -40°C to +55°C.
- D Emergency** - Available with a self-contained battery system or V-CG-S module for monitoring with an Eaton central battery system.

† Operating temperature range may vary by lumen models within a product family. Refer to product catalog pages for complete temperature range details.



Adverse

+55°C

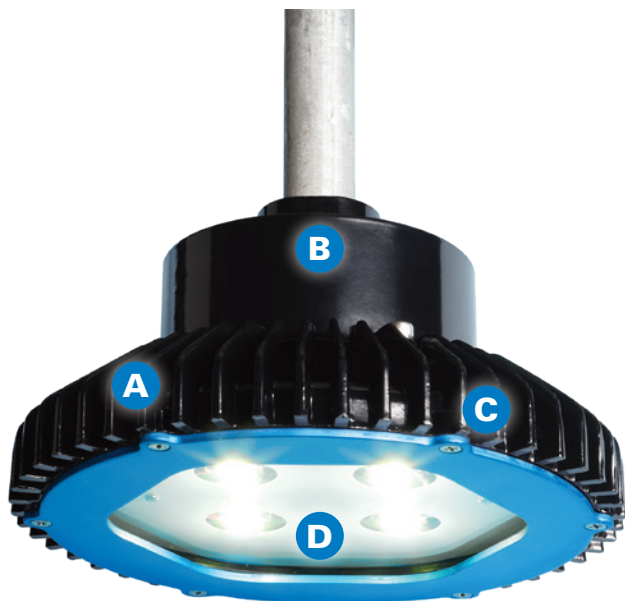

90% more energy-efficient than a 200 watt incandescent and over 20 times the rated life

DESIGN FEATURES

- A Domeless reflector, low profile design** - Designed for low mounting heights and confined spaces where incandescent and HID based luminaires are too large.
- B Installation and replacement made simple** - Installed using the same mounting modules as existing Eaton's Crouse-Hinds Vaporgard fixtures.
- C Safe, reliable heat transfer** - Heat sink engineered to safely and effectively remove heat from the LED and driver, ensuring long product life and superior T-ratings.
- D High power multi-die LED arrays** - Provides instant on and full illumination in the harshest conditions, even when exposed to high, repeated vibration.

Vaporgard™ Pro P2L/P3L LED light fixtures

PRIMARY APPLICATIONS

Indoor or outdoor areas with low mounting heights or confined spaces, such as tunnels and catwalks, over doorways or entries, landing areas, utility rooms, etc.

LUMINAIRE MODELS

Model number	Equivalent HID luminaire	Typical energy savings/lifetime
P2LM2	50W HID or 150-200W incandescent	Up to 90% reduction in energy costs and 50,000 hours of continuous operation!
P3LM2		

CERTIFICATIONS & COMPLIANCES

- UL1598
- UL1598A Marine
- cUL Listed to CSA Standard CSA C22.2 No. 250
- Type 4X, IP66, Wet Locations

ELECTRICAL RATINGS

- Voltages: 120-277 VAC, 10-30 VDC
- Input power: 14W, 29W

OPTIONS AND ACCESSORIES

- Diffused glass or polycarbonate lens
- Teflon coated lens
- Warm white (3000K), neutral (4000K) and cool white (5000K) color temperatures
- 10-30 VDC driver
- Wall, ceiling, pendant and stanchion mounts

† Operating temperature range may vary by lumen models within a product family. Refer to product catalog pages for complete temperature range details.

IHBE high bay LED

PRIMARY APPLICATIONS

IHBE LED fixtures are the perfect replacement for 250W to 1,500W+ HID and 2-10 lamp T8, T12 and T5HO fluorescent high bay fixtures.

LUMINAIRE MODELS

Model number	Equivalent HID luminaire	Typical energy savings/lifetime
IHBE-13L	400W-600W	Up to 77% reduction in energy costs and 60,000 hours of continuous operation!
IHBE-20L	600W-750W	
IHBE-30L	750W-1000W	
IHBE-50L	1500W-2000W	

CERTIFICATIONS & COMPLIANCES

- UL1598
- IP65
- CSA C22.2 No. 250
- RoHS 3

ELECTRICAL RATINGS

- Voltages: 120-277 VAC/127-400 VDC, 347-480 VAC
- Input power: 100W, 150W, 237W, 395W

OPTIONS AND ACCESSORIES

- Warm white (3000K), neutral white (4000K) or cool white (5700K) color temperatures
- Narrow and wide beam optics available
- Occupancy sensor with remote control
- Hanging mount or trunnion mount
- Available with cord assemblies and plugs

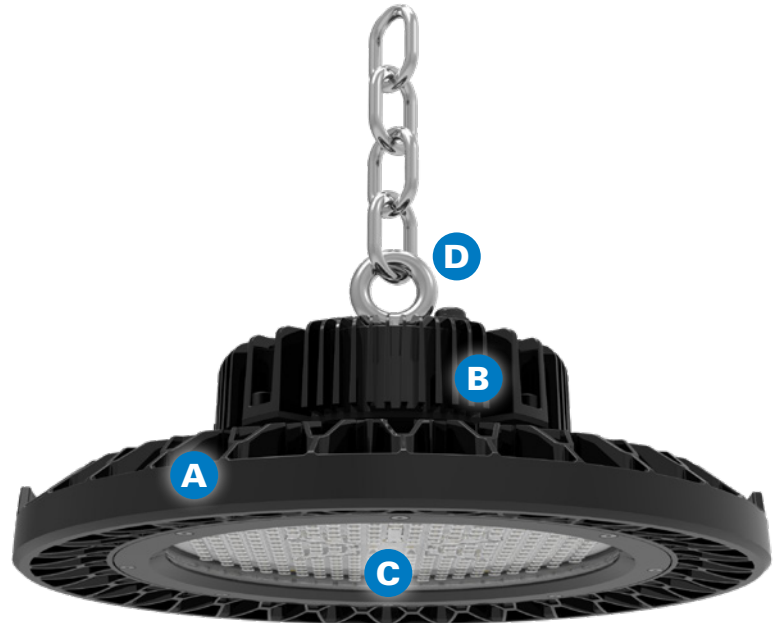
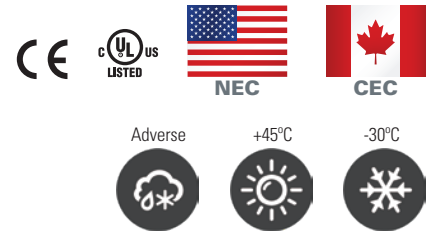

4 models from 13,000 to 52,000 lumens and up to 77% energy savings.

DESIGN FEATURES

- A Energy efficient** - Up to 133 lumens per watt.
- B Built to last** - Constructed of heavy duty, die cast aluminum with polycarbonate lens and optics.
- C Custom optics** - narrow and wide beam options ensure superior performance to key areas within an application.
- D Easy installation & maintenance** - Serviceable drivers and cord option provide fast installation and maintenance.

† Operating temperature range may vary by lumen models within a product family. Refer to product catalog pages for complete temperature range details.



NEC



CEC

Adverse

+45°C

-30°C

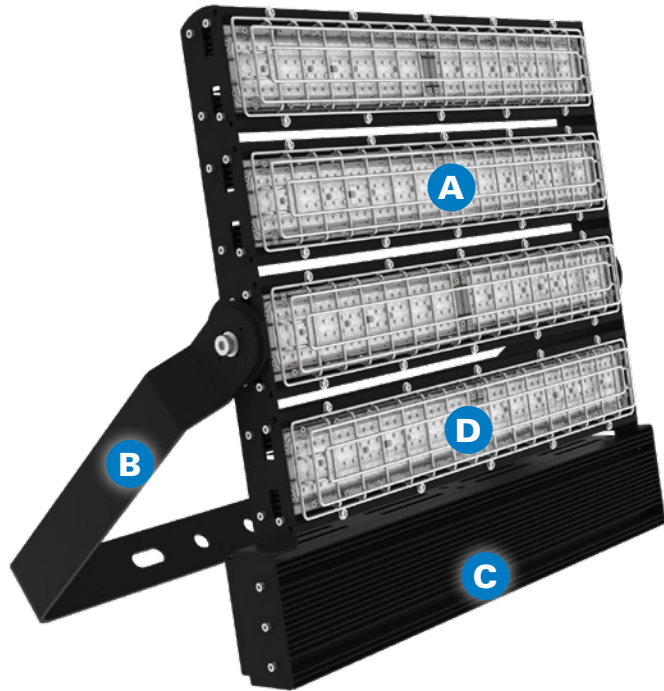

4 models from 15,000 to 79,000 lumens

DESIGN FEATURES

- A Increased efficiency** - Up to 130 lumens per watt.
- B Multiple mounting options** - Standard trunnion mount and optional pole mount available.
- C Aluminum heat sinks for superior thermal management.**
- D Multiple color temperature options** - 3000K warm, 4000K neutral and 5000K cool white options available.

† Operating temperature range may vary by lumen models within a product family. Refer to product catalog pages for complete temperature range details.

PFME LED floodlights

PRIMARY APPLICATIONS

PFME LED floodlights are the perfect replacement for HID flood and area lighting in indoor and outdoor light industrial areas.

LUMINAIRE MODELS

Model number	Equivalent HID luminaire	Typical energy savings/lifetime
PFME15L	500W	Up to 72% reduction in energy costs and 50,000 hours of continuous operation!
PFME30L	750W-1000W	
PFME60L	1500+W	
PFME75L	1500+W	

CERTIFICATIONS & COMPLIANCES

- UL1598
- Wet Locations, IP65
- CSA C22.2 No. 250

ELECTRICAL RATINGS

- Voltages: 120-277 VAC/127-400 VDC, 277-480 VAC
- Input power: 120.2W, 242.2W, 484.5W, 603.5W

OPTIONS AND ACCESSORIES

- Photocell
- Wire guards and visor kits
- Narrow and standard optics options
- Replaceable driver kits

IHB high bay LED luminaire

PRIMARY APPLICATIONS

IHB LED luminaires are the perfect replacement for 250W-1,500W HID and 4-10 lamp T5HO fluorescent high bay fixtures. Designed for locations requiring continuous and consistent light levels, requiring frequent on-and-off of lights and that are difficult to relamp or that cause production to be stopped during the lamp maintenance process.

LUMINAIRE MODELS

Model number	Equivalent luminaire	Typical energy savings/lifetime
IHB16L	250-500W HID or 4 lamp T5HO	Up to 72% reduction in energy costs and 60,000 hours of continuous operation!
IHB24L	400-750W HID or 4-6 lamp T5HO	
IHB32L	500-1000W HID or 6-8 lamp T5HO	
IHB48L	750-1,500W HID or 8-10 lamp T5HO	
IHB64L	1,000-1,500W HID or 10 lamp T5HO	

*8L option available; consult factory for availability.

CERTIFICATIONS & COMPLIANCES

- UL1598; UL8750
- cULus
- Damp locations

ELECTRICAL RATINGS

- Voltages: 100-277 VAC/127-250 VDC, 347-480 VAC
- Input power: 145W, 216W, 289W, 436W, 582W

OPTIONS AND ACCESSORIES

- Occupancy sensor kits
- Diffused or clear lens (glass or polycarbonate)
- Lens guard
- Open ended and closed dust cover kits
- Dimmable driver
- Wide or aisle optic
- Pendant, aircraft cable or jack chain mounting



NEC



CEC



IEC/ATEX

Adverse



+60°C



-40°C

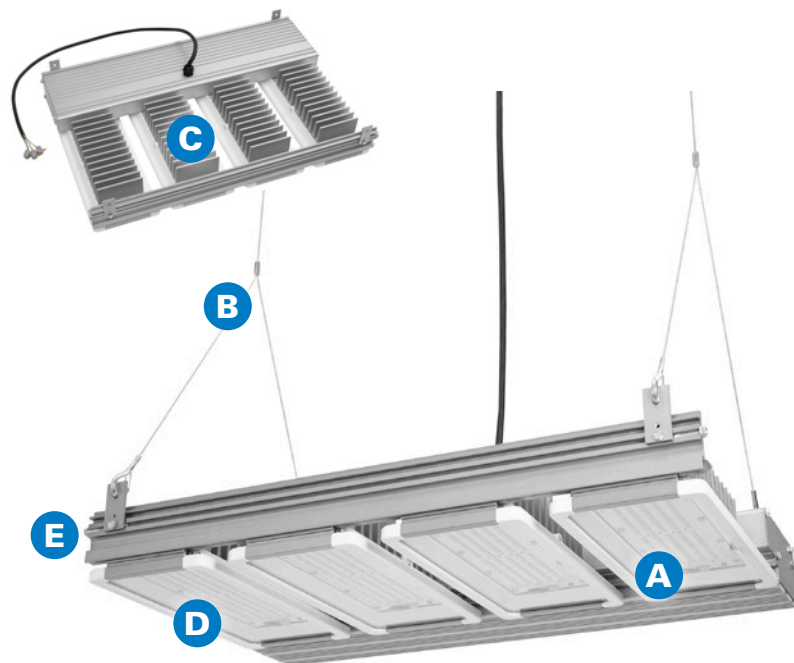

Perfect replacement for 250-1500 watt HID or 4-10 lamp T5HO fixtures

DESIGN FEATURES

- A Increased efficiency** - Up to 117 lumens per watt.
- B Multiple mounting options** - Available with pendant, aircraft cable or jack chain mounting.
- C Aluminum heat sinks for superior thermal management.**
- D Multiple lens options** - Tempered and clear glass standard, diffused glass and clear or diffused polycarbonate options available.
- E Optional occupancy sensor kit available.**

† Operating temperature range may vary by lumen models within a product family. Refer to product catalog pages for complete temperature range details.

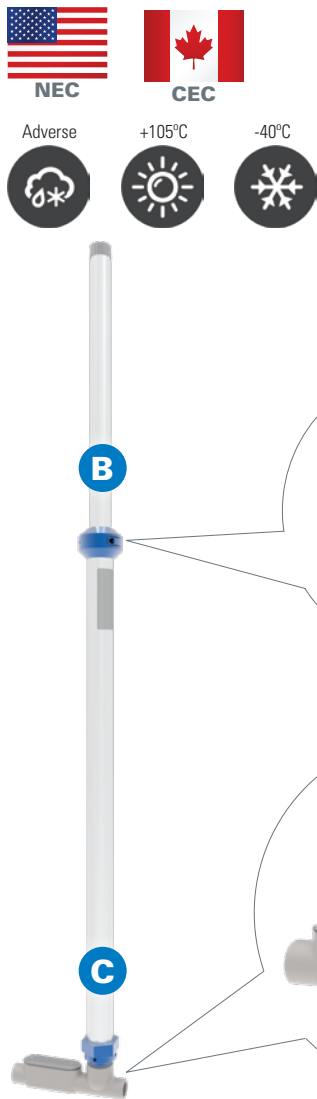

Install lighting faster, reduce safety hazards and costly methods

DESIGN FEATURES

V-SPRING TELESCOPING LIGHT POLE

- A Simple vertical travel** - Easily extend to any height – one product covers multiple mounting heights and ensures safer installation.
Note: The maximum raised height of 9.0' and compressed height of 5.4' for easy installation.
- B Easy fixture rotation** - Adjustable 360° pole rotation allows for effortless positioning of lights or cameras.
- C Fully assembled and wired** - Factory assembled, wired and sealed for maximum environmental protection.

CONDULET LIGHTING TEE

- D Easy access** - Top entry allows the installer to make connections quickly.
- E Safer to install** - Top entry access for wiring makes installation safer – no need to lean beyond handrail protection.
- F Industry standard sizing** - 1-1/2" trade size vertical hub is designed to accept V-Spring and other industry standard light poles.

† Operating temperature range may vary by lumen models within a product family. Refer to product catalog pages for complete temperature range details.

V-Spring™ telescoping safety light pole & Condulet™ lighting tee

PRIMARY APPLICATIONS

For luminaires installed on industrial walkways, platforms, stairways and conveyors where OSHA/ HSE regulations require fall prevention equipment and in hard to reach or dangerous areas where safety is a big concern.

MODELS

V-SPRING LIGHT POLE

Model number	Description
V65-A	Aluminum V-Spring telescoping light pole
V65-G	Galvanized steel V-Spring telescoping light pole
V65-S	Stainless steel V-Spring telescoping light pole

CONDULET LIGHTING TEE

Model number	Description
LTEE2	Lighting Tee with 3/4" feed thru hubs and 1-1/2" vertical hub, Feraloy® iron
LTEE2 SA	Lighting Tee with 3/4" feed thru hubs and 1-1/2" vertical hub, copper free aluminum
LTEE3	Lighting Tee with 1" feed thru hubs and 1-1/2" vertical hub, Feraloy iron
LTEE3 SA	Lighting Tee with 1" feed thru hubs and 1-1/2" vertical hub, copper free aluminum

CERTIFICATIONS & COMPLIANCES

V-Spring certifications & compliances

- UL1598
- CSA C22.2 No. 250.0-08
- cULus listed for Class I, Division 2, Class II, Division 2 when used with Champ series luminaires
- Dusttight, NEMA 4, IP66
- Wind rated to 230 mph per AASHTO standards
- DNV No. 2.4: 2006
- IEC 60068-2-6: 2007

Lighting tee certifications & compliances

- UL514B, UL50E dusttight Type 12
- CSA standard: C22.2 No. 18
- NEMA 3R raintight (when installed with 380G or 380G SA integral gasketed covers)

V-SPRING CABLE RATINGS

- 12/3 AWG UL/CSA Listed
- 600V, -40°C to 105°C
- Sun- and oil-resistant, FT1, FT2
- ROHS II reach

For more information,
visit Eaton.com/lighting.

**U.S. (Global Headquarters):
Eaton's Crouse-Hinds Division**

1201 Wolf Street
Syracuse, NY 13208

(866) 764-5454
FAX: (315) 477-5179

Orders Only:
ECHUSAOorders@eaton.com

CrouseCustomerCTR@eaton.com

For more information:

If further assistance is required, please contact an authorized Eaton Distributor, Sales Office, or Customer Service Department.

Canada

Toll Free: 800-265-0502
FAX: (800) 263-9504
FAX Orders only: (866) 653-0645

Mexico/Latin America/Caribbean

52-555-804-4000
FAX: 52-555-804-4020
ventascentromex@eaton.com

Europe (Germany)

49 (0) 6271 806-500
49 (0) 6271 806-476
info-ex@eaton.com

Eaton Middle East

9714-8066100
FAX: 9714-8894813
chbl-me@eaton.com

Singapore

65-6825-1668
FAX: 65-6645-9811
chsi-sales@eaton.com

China

86-21-2899-3600
FAX: 86-21-2899-4055
echsales@eaton.com

Korea

82 2 6380 4032
82-2-6380-4070
ECHKsales@eaton.com

Australia

1300-332-866
FAX: 61-2-9693-5127
Crousehindsanz@eaton.com

India

91-124-4683888
FAX: 91-124-4683899
cchindia@eaton.com

Eaton
1000 Eaton Boulevard
Cleveland, OH 44122
United States
Eaton.com

Crouse-Hinds Division
1201 Wolf Street
Syracuse, NY 13208
Crouse-Hinds.com

© 2025 Eaton
All Rights Reserved
Printed in USA
Publication No. 5100-0524
February 2025

Eaton is a registered trademark.

All other trademarks are property of their respective owners.

Follow us on social media to get the latest product and support information.

